

Lag <b>1</b>	Skive <b>2</b>	<b>Tobias Berg</b>	
-----------------	-------------------	--------------------	--

Luft	Hasle/Ise SSL	R12	
------	---------------	-----	--

16.04.2015	Landsstevnet rekrutt 2015	LS Rekrutt 2015
------------	---------------------------	-----------------

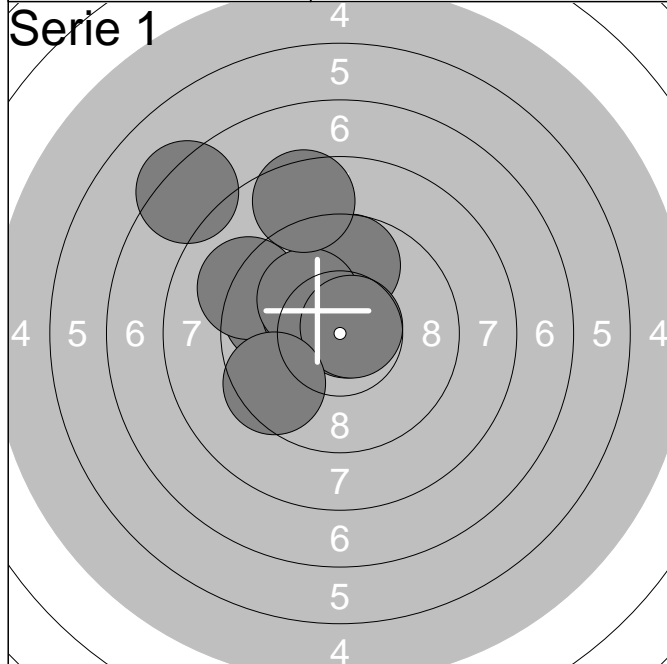

1:	9.7	↖
2:	10.8x	↗
3:	9.2	↖
4:	7.3	↗
5:	10.3x	↗
6:	9.7	↑
7:	10.1	↗
8:	10.7x	↗
9:	8.5	↑
10:	9.4	↙
<b>Serie</b>		<b>91.0</b>
<b>Total</b>		<b>91.0</b>

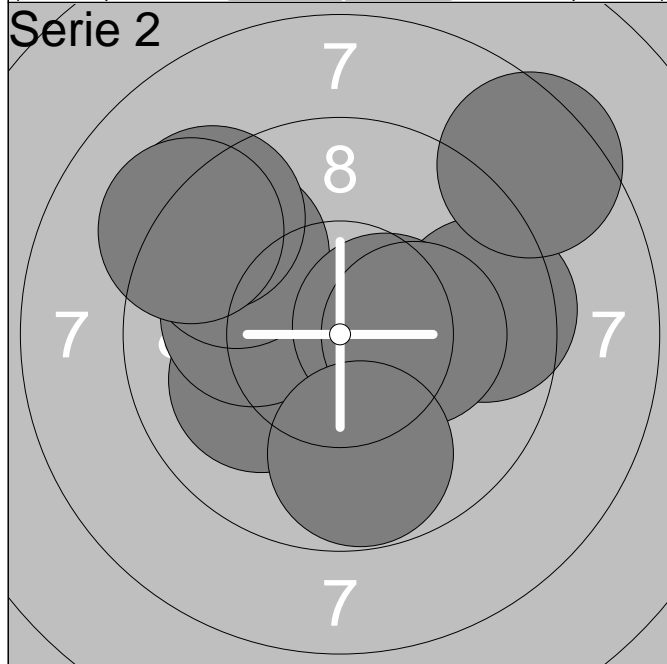

1:	9.5	→
2:	10.1	↖
3:	10.1	↖
4:	9.7	↗
5:	8.5	↗
6:	9.3	↗
7:	10.5x	→
8:	10.2x	→
9:	9.2	↗
10:	9.7	↓
<b>Serie</b>		<b>93.0</b>
<b>Total</b>		<b>184.0</b>

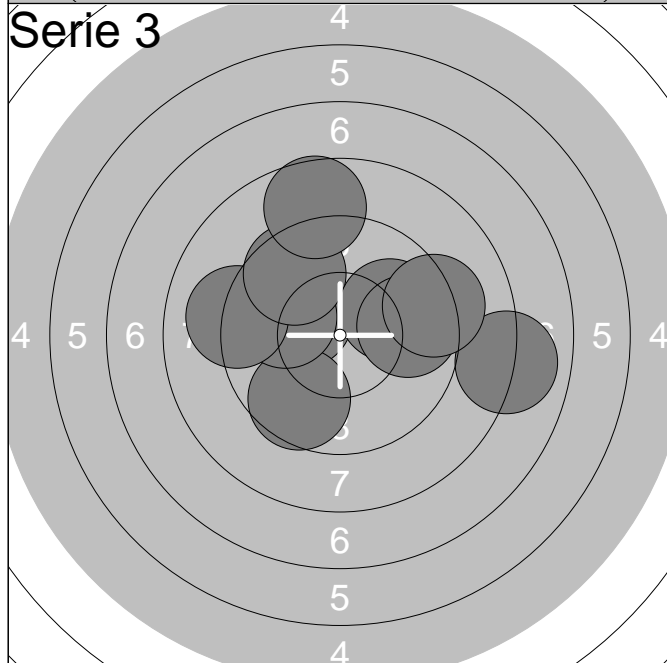

1:	10.2x	↖
2:	9.6	↙
3:	9.9	↖
4:	8.0	→
5:	9.1	↖
6:	9.6	↗
7:	9.9	↗
8:	9.7	→
9:	8.6	↑
10:	9.2	→
<b>Serie</b>		<b>89.0</b>
<b>Total</b>		<b>273.0</b>

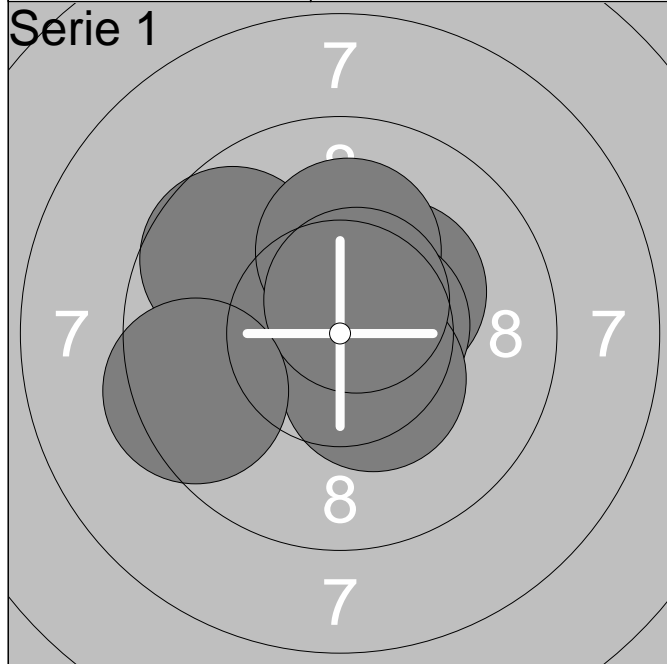

1:	10.0	↖
2:	10.7x	↗
3:	10.7x	↗
4:	10.3x	↗
5:	9.7	↖
6:	10.1	↑
7:	10.6x	→
8:	10.4x	↘
9:	10.5x	↗
10:	9.4	↖
<b>Serie</b>		<b>98.0</b>
<b>Total</b>		<b>98.0</b>

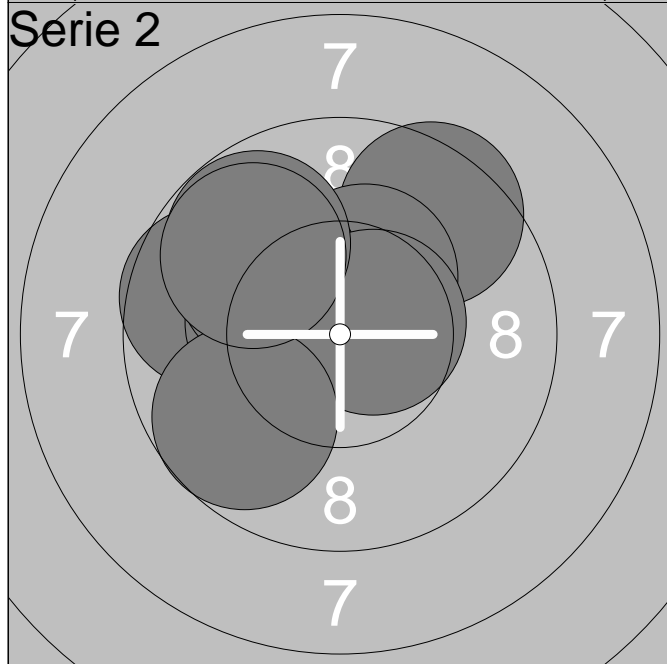

1:	10.8x	↑
2:	9.6	↖
3:	10.3x	↖
4:	9.5	↗
5:	10.3x	↗
6:	10.0	↖
7:	10.6x	→
8:	9.7	↖
9:	9.7	↗
10:	9.8	↗
<b>Serie</b>		<b>95.0</b>
<b>Total</b>		<b>193.0</b>



1:	9.5	↑
2:	10.6x	↑
3:	10.6x	↗
4:	10.2x	→
5:	10.0	↖
6:	10.4x	↑
7:	10.0	↖
8:	10.3x	↗
9:	10.1	↗
10:	9.8	↖
<b>Serie</b>		<b>98.0</b>
<b>Total</b>		<b>291.0</b>

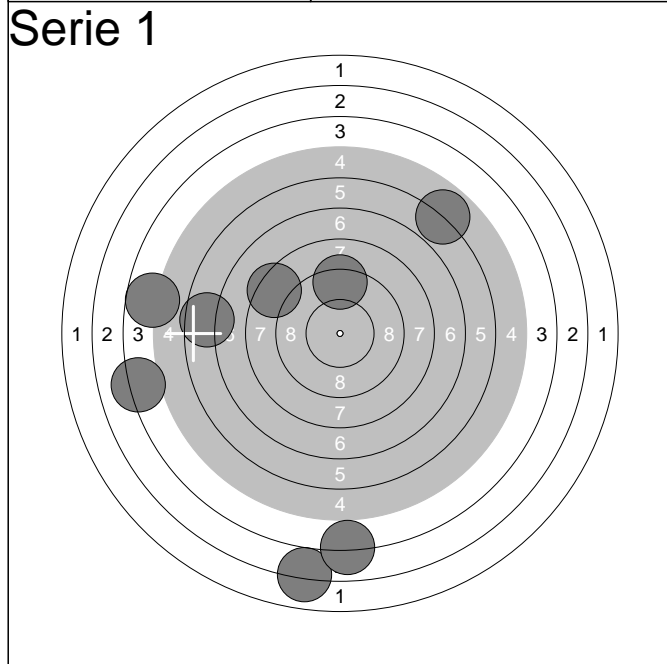

1:	4.7	←
2:	3.0	↓
3:	0.0	←
4:	9.2	↑
5:	4.1	←
6:	0.0	↗
7:	8.4	↗
8:	5.9	↗
9:	6.6	←
10:	3.9	↓
<b>Serie</b>		<b>42.0</b>
<b>Total</b>		<b>42.0</b>

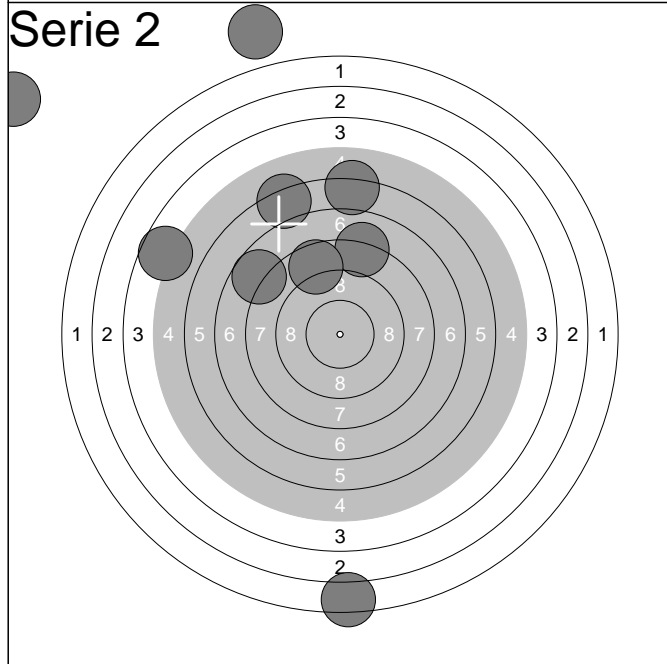

1:	0.0	↑
2:	0.0	↗
3:	8.1	↑
4:	4.6	←
5:	6.1	↑
6:	0.0	↑
7:	7.7	↗
8:	2.3	↓
9:	6.2	↑
10:	8.6	↑
<b>Serie</b>		<b>41.0</b>
<b>Total</b>		<b>83.0</b>

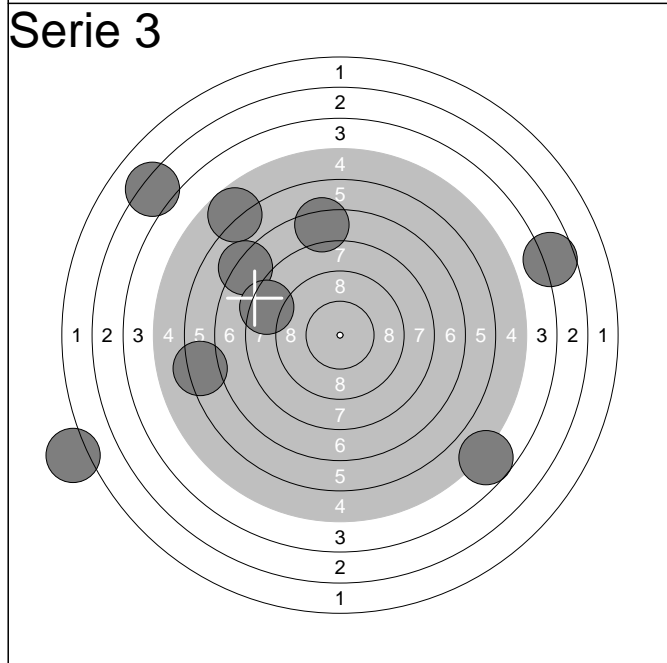

1:	4.7	↘
2:	7.3	↑
3:	3.2	↗
4:	6.3	←
5:	5.7	↗
6:	1.4	←
7:	7.2	↗
8:	3.6	→
9:	0.0	↗
10:	8.4	←
<b>Serie</b>		<b>44.0</b>
<b>Total</b>		<b>127.0</b>

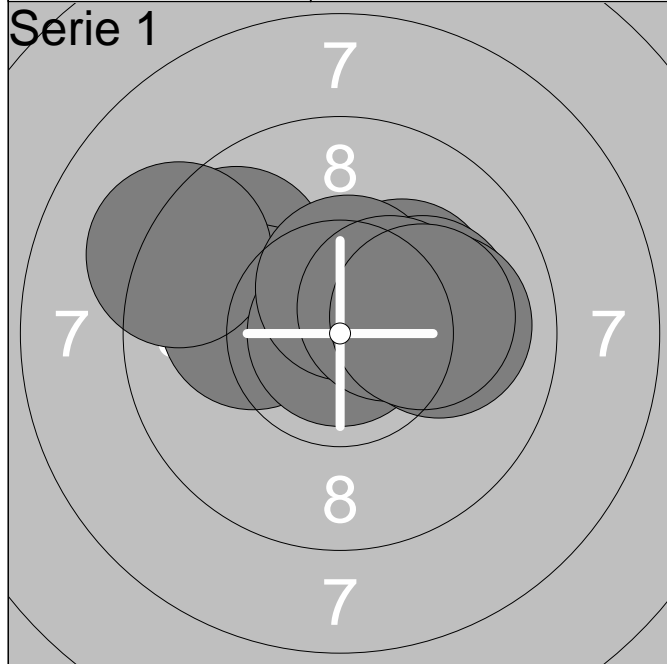

1:	9.7	↗
2:	10.1	↖
3:	9.2	↗
4:	10.2x	↗
5:	10.1	→
6:	10.9x	→
7:	10.5x	↑
8:	10.0	→
9:	10.4x	↗
10:	10.1	→
<b>Serie</b>		<b>98.0</b>
<b>Total</b>		<b>98.0</b>

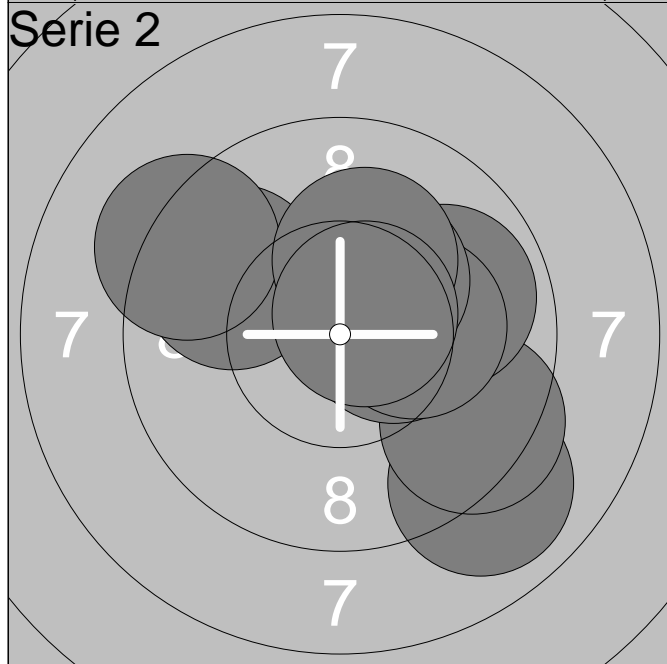

1:	8.9	↘
2:	9.7	↗
3:	9.4	↘
4:	9.8	→
5:	10.4x	→
6:	10.2x	→
7:	9.2	↗
8:	10.3x	↗
9:	10.2x	↗
10:	10.6x	↗
<b>Serie</b>		<b>94.0</b>
<b>Total</b>		<b>192.0</b>

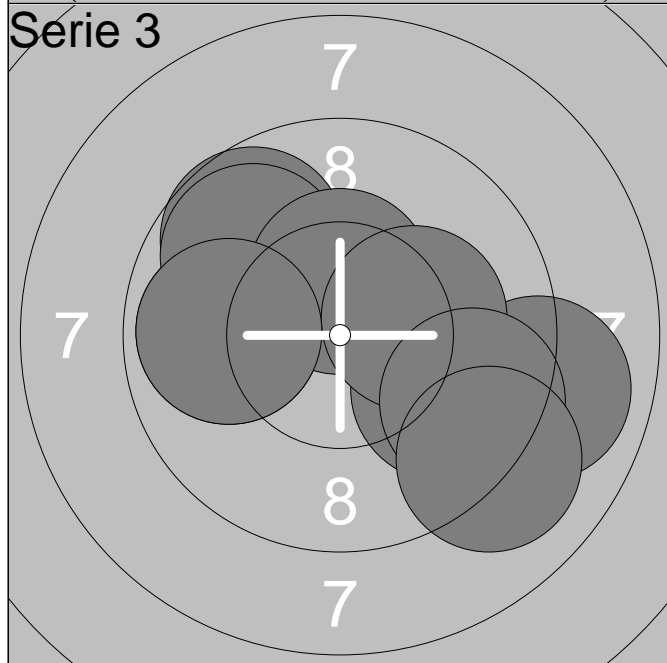

1:	9.9	↖
2:	9.7	↗
3:	9.8	↗
4:	8.9	→
5:	9.8	↘
6:	10.4x	↑
7:	10.2x	→
8:	9.5	↘
9:	9.0	↘
10:	9.8	↖
<b>Serie</b>		<b>91.0</b>
<b>Total</b>		<b>283.0</b>

Lag	Skive	Lars Oskar Pinaas	
<b>1</b>	<b>6</b>		

Luft	Hasle/Ise SSL	R12	
------	---------------	-----	--

16.04.2015	Landsstevnet rekrutt 2015	LS Rekrutt 2015	
------------	---------------------------	-----------------	--

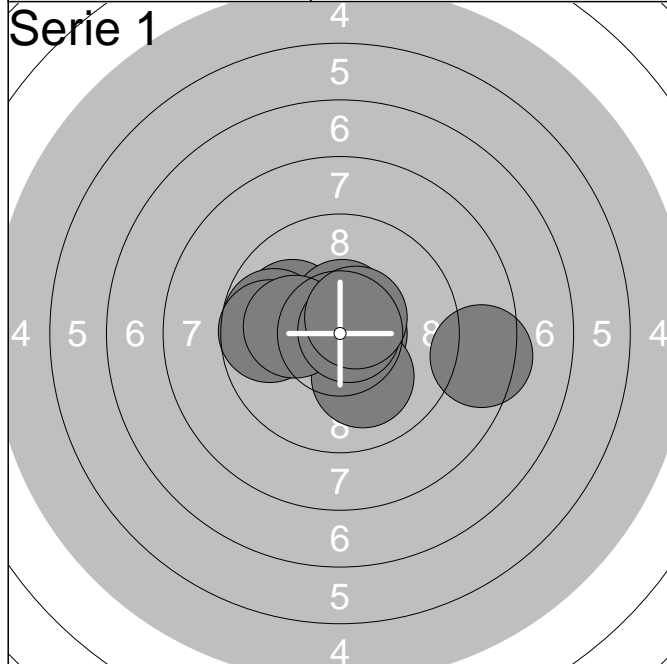

1:	8.4	→
2:	10.0	↖
3:	9.7	←
4:	10.5x	↑
5:	10.7x	→
6:	9.7	←
7:	10.1	↓
8:	10.1	←
9:	10.8x	→
10:	10.5x	↗
<b>Serie</b>		<b>96.0</b>
<b>Total</b>		<b>96.0</b>

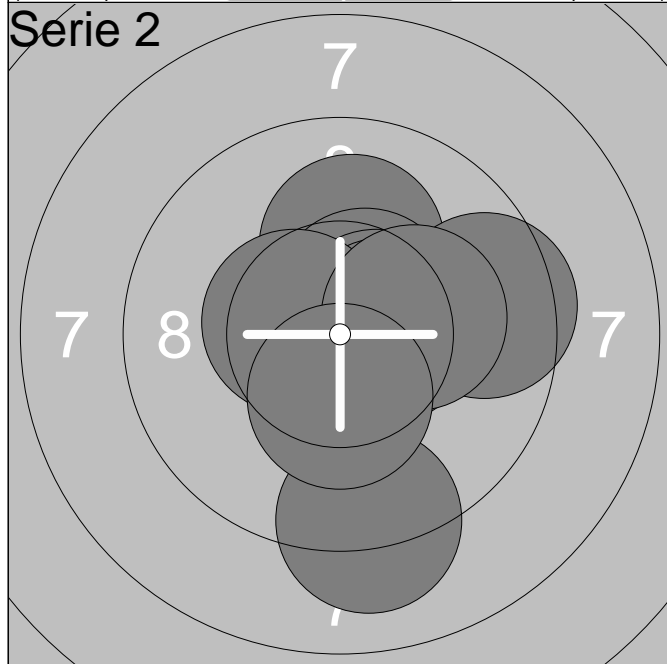

1:	9.1	↓
2:	10.7x	↗
3:	10.1	↑
4:	10.5x	↗
5:	10.6x	→
6:	9.5	→
7:	10.5x	→
8:	10.5x	←
9:	10.2x	→
10:	10.3x	↓
<b>Serie</b>		<b>98.0</b>
<b>Total</b>		<b>194.0</b>

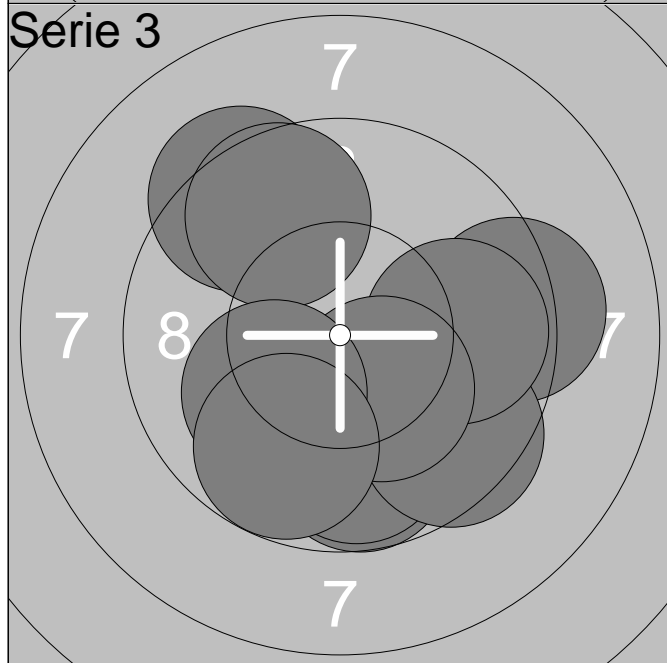

1:	9.2	→
2:	9.7	↓
3:	9.8	↓
4:	9.5	↓
5:	9.8	→
6:	10.3x	↓
7:	9.3	↗
8:	9.6	↗
9:	10.1	↖
10:	9.7	↓
<b>Serie</b>		<b>92.0</b>
<b>Total</b>		<b>286.0</b>

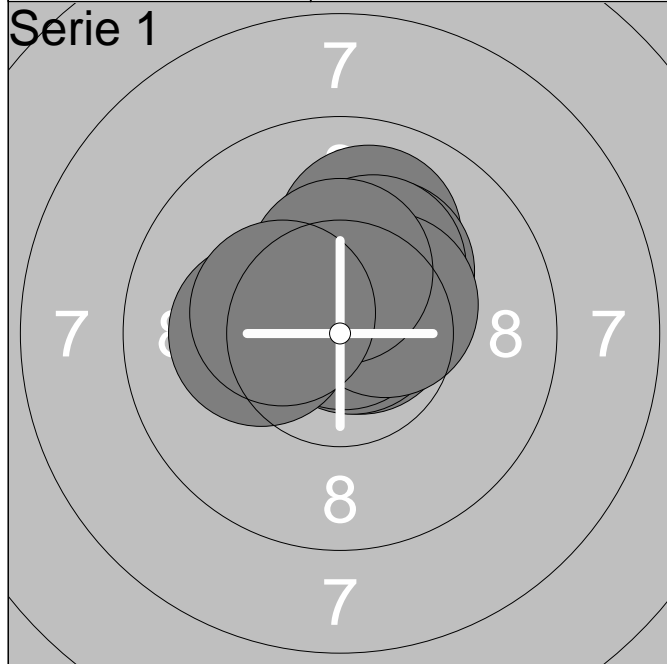

1:	10.0	↑
2:	10.7x	↗
3:	10.8x	↗
4:	10.8x	↑
5:	10.2x	←
6:	10.2x	↗
7:	10.2x	↗
8:	10.4x	↗
9:	10.3x	↑
10:	10.3x	↖
<b>Serie</b>		<b>100.0</b>
<b>Total</b>		<b>100.0</b>

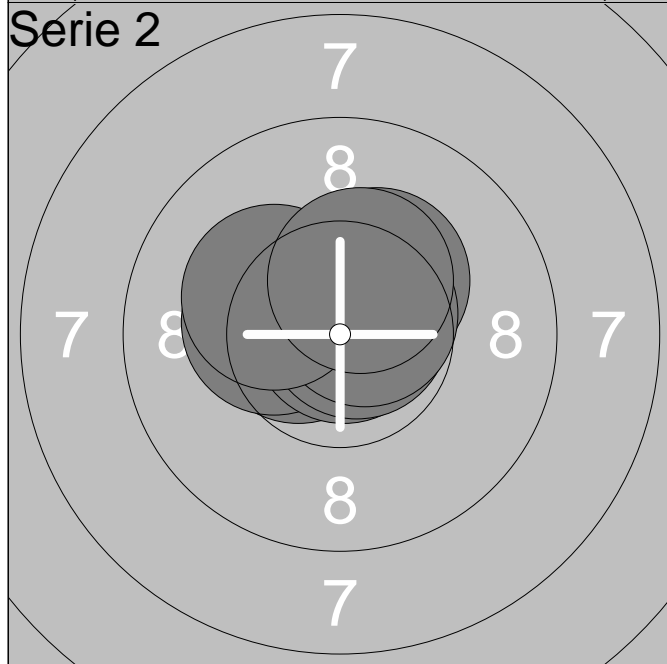

1:	10.5x	←
2:	10.3x	←
3:	10.9x	↗
4:	10.3x	↗
5:	10.6x	↑
6:	10.7x	↑
7:	10.7x	↗
8:	10.6x	↗
9:	10.2x	↖
10:	10.4x	↑
<b>Serie</b>		<b>100.0</b>
<b>Total</b>		<b>200.0</b>



1:	10.2x	↓
2:	10.2x	↗
3:	10.0	↗
4:	10.2x	↗
5:	10.5x	←
6:	10.5x	←
7:	9.4	↓
8:	10.8x	↗
9:	10.8x	↗
10:	10.7x	→
<b>Serie</b>		<b>99.0</b>
<b>Total</b>		<b>299.0</b>

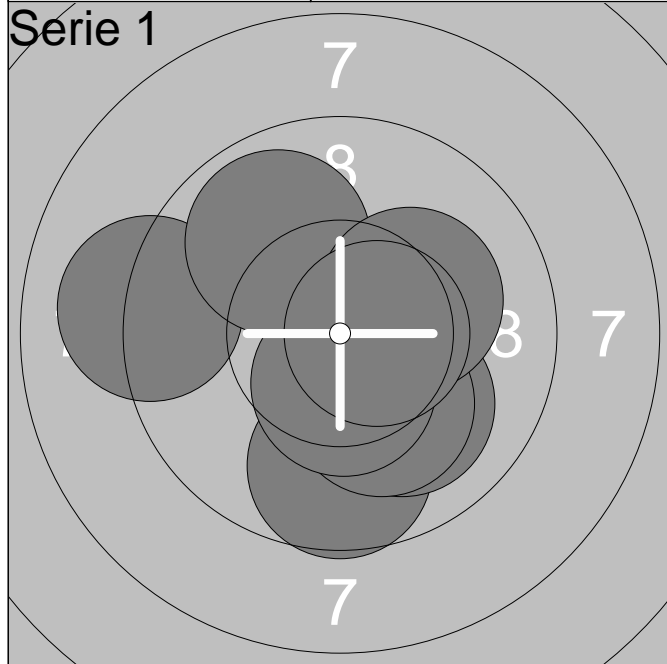

1:	10.6x	→
2:	9.6	↓
3:	10.3x	→
4:	10.0	↓
5:	9.1	←
6:	10.1	↓
7:	10.4x	↓
8:	9.9	↑
9:	10.2x	→
10:	10.6x	→

Serie	97.0
Total	97.0

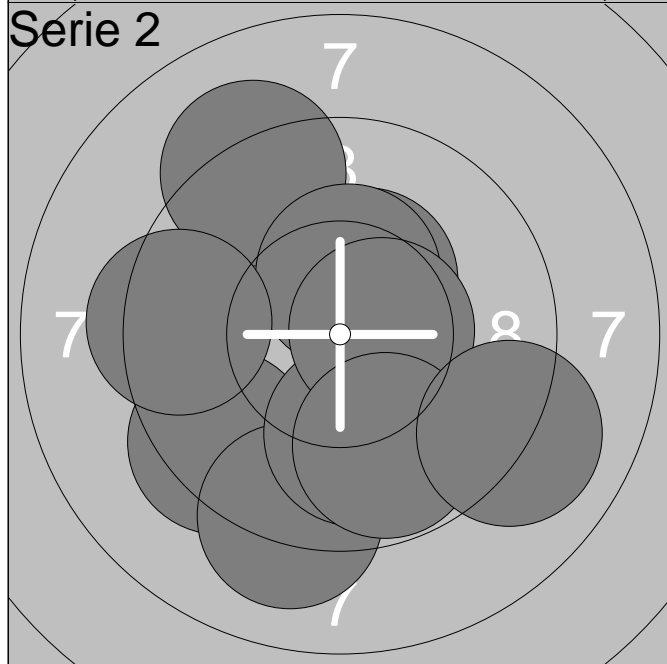

1:	9.2	↑
2:	9.4	↙
3:	10.3x	↑
4:	10.4x	↑
5:	9.1	↓
6:	9.4	←
7:	10.0	↓
8:	10.5x	→
9:	9.8	↓
10:	9.0	↘

Serie	94.0
Total	191.0

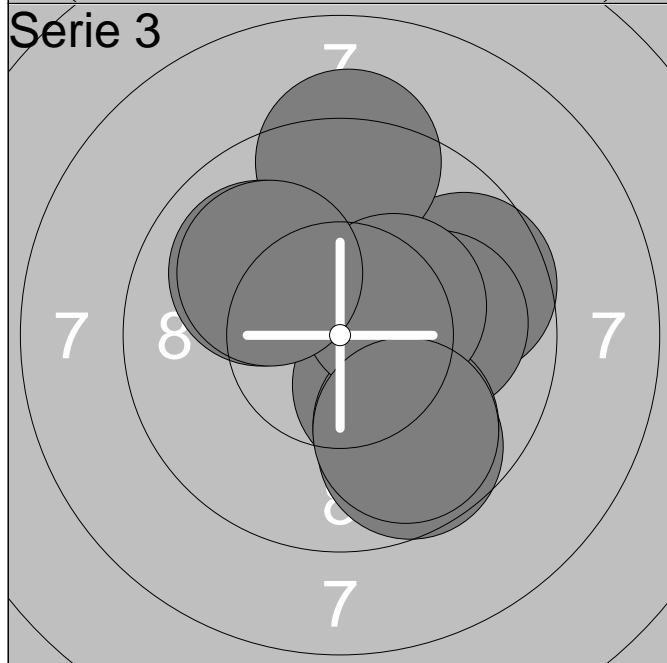

1:	9.6	→
2:	9.2	↑
3:	9.7	↓
4:	10.3x	↓
5:	10.0	→
6:	9.8	↓
7:	10.3x	→
8:	10.0	↑
9:	10.0	↑
10:	9.8	↓

Serie	95.0
Total	286.0

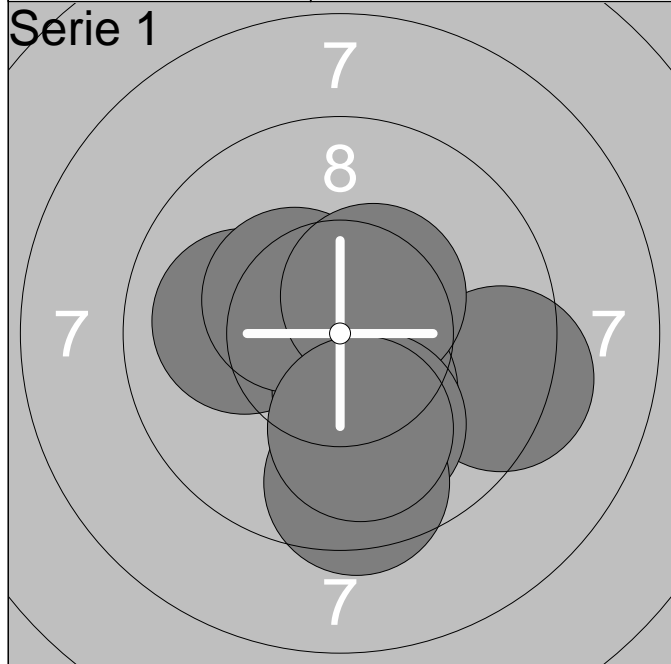

1:	10.5x	↗
2:	10.0	←
3:	9.3	→
4:	10.3x	↓
5:	10.8x	→
6:	10.4x	↗
7:	10.4x	↗
8:	10.0	↓
9:	9.5	↓
10:	10.0	↓
<b>Serie</b>		<b>98.0</b>
<b>Total</b>		<b>98.0</b>

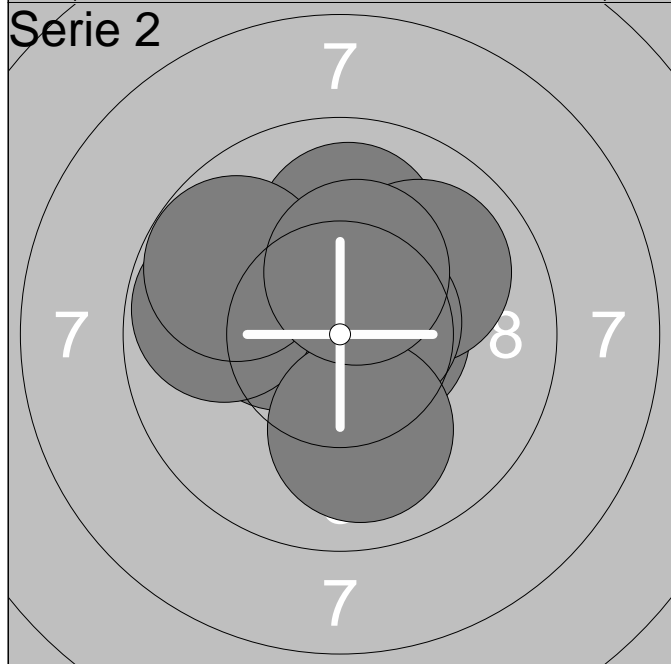

1:	10.0	↑
2:	10.6x	→
3:	10.4x	↗
4:	10.0	↗
5:	10.4x	←
6:	10.6x	→
7:	9.8	←
8:	9.7	↗
9:	10.0	↓
10:	10.3x	↑
<b>Serie</b>		<b>98.0</b>
<b>Total</b>		<b>196.0</b>



1:	10.7x	→
2:	10.7x	↗
3:	9.9	↗
4:	10.2x	→
5:	10.4x	→
6:	10.2x	↑
7:	10.0	↗
8:	9.8	↑
9:	10.2x	↗
10:	10.5x	→
<b>Serie</b>		<b>98.0</b>
<b>Total</b>		<b>294.0</b>



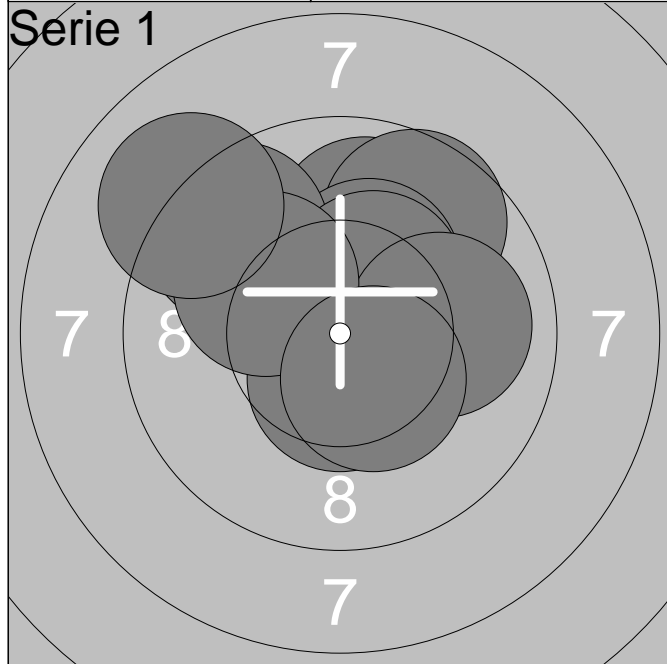

1:	9.9	↑
2:	9.6	↗
3:	10.3x	↑
4:	9.5	↗
5:	10.4x	↑
6:	10.0	→
7:	10.5x	↓
8:	10.1	↗
9:	9.0	↗
10:	10.4x	↓
<b>Serie</b>	<b>96.0</b>	
<b>Total</b>	<b>96.0</b>	

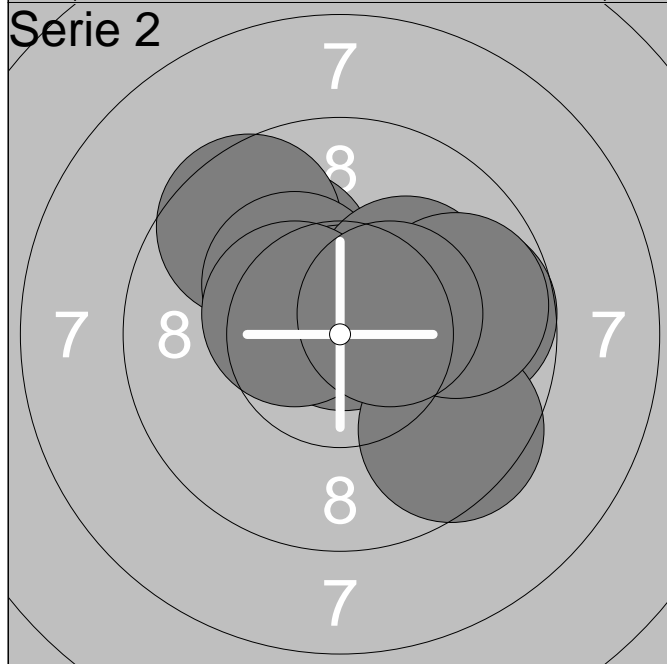

1:	10.0	↗
2:	9.6	↗
3:	9.7	→
4:	10.3x	↗
5:	10.7x	↑
6:	10.2x	↗
7:	9.5	↓
8:	10.4x	↗
9:	9.8	→
10:	10.4x	↗
<b>Serie</b>	<b>96.0</b>	
<b>Total</b>	<b>192.0</b>	



1:	9.2	→
2:	9.5	→
3:	10.4x	↓
4:	10.0	↗
5:	10.3x	↓
6:	9.7	↑
7:	10.0	↓
8:	10.1	↗
9:	10.2x	↓
10:	10.3x	↓
<b>Serie</b>	<b>97.0</b>	
<b>Total</b>	<b>289.0</b>	

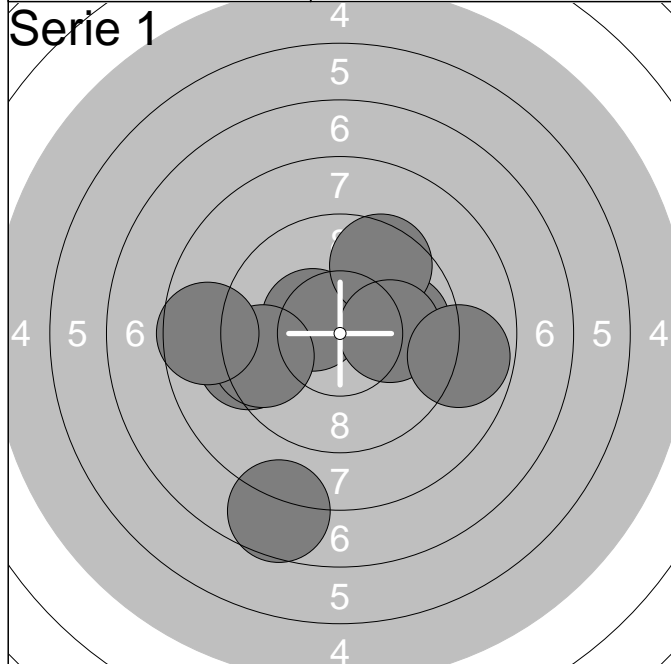

1:	10.0	→
2:	7.6	↓
3:	9.9	→
4:	9.3	←
5:	10.4x	↖
6:	9.5	←
7:	8.6	←
8:	9.5	↗
9:	10.1	→
10:	8.8	→
<b>Serie</b>		<b>89.0</b>
<b>Total</b>		<b>89.0</b>

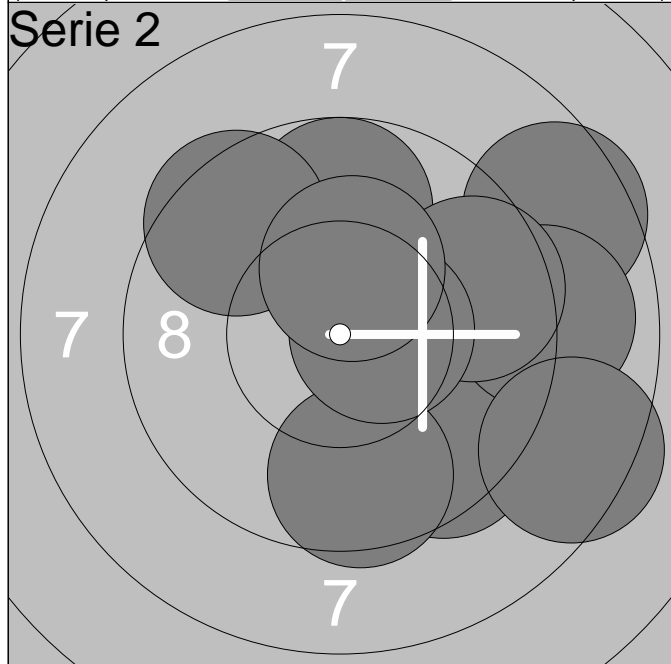

1:	9.5	↘
2:	9.7	↑
3:	9.4	↖
4:	8.6	↗
5:	8.9	→
6:	9.6	↓
7:	9.6	→
8:	10.5x	→
9:	8.4	↘
10:	10.3x	↑
<b>Serie</b>		<b>89.0</b>
<b>Total</b>		<b>178.0</b>

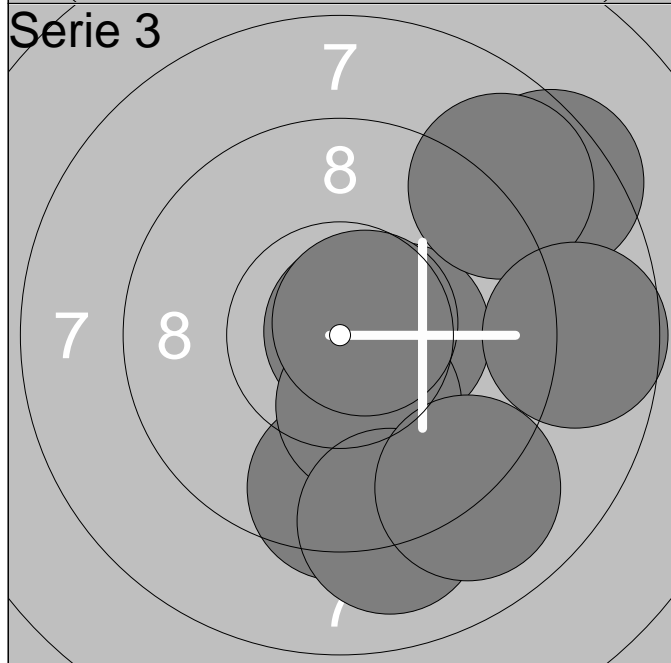

1:	8.4	↗
2:	10.7x	→
3:	10.4x	→
4:	9.5	↓
5:	8.8	↗
6:	10.2x	↓
7:	8.7	→
8:	9.0	↓
9:	10.7x	↗
10:	9.0	↘
<b>Serie</b>		<b>91.0</b>
<b>Total</b>		<b>269.0</b>

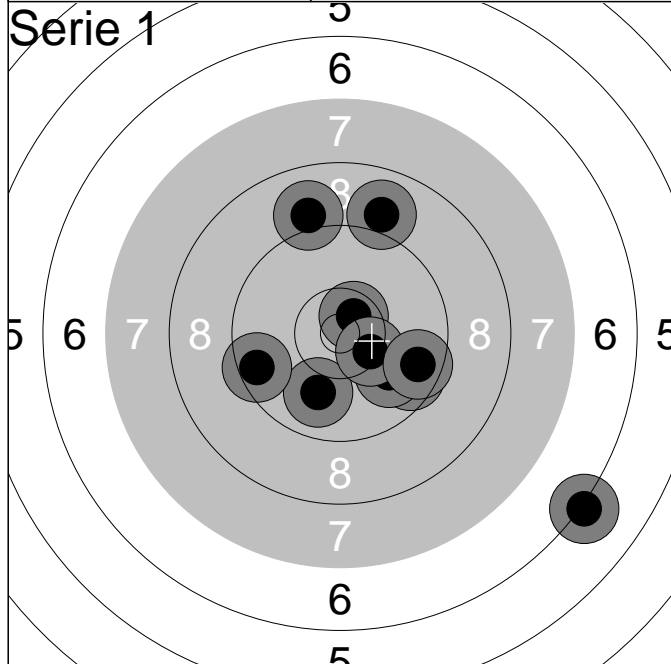

1:	10.6x	↗
2:	6.2	↘
3:	9.0	↑
4:	9.9	↓
5:	9.6	↘
6:	9.9	↘
7:	9.5	↖
8:	8.9	↑
9:	10.4x	↘
10:	9.6	↘
<b>Serie</b>		<b>88.0</b>
<b>Total</b>		<b>88.0</b>

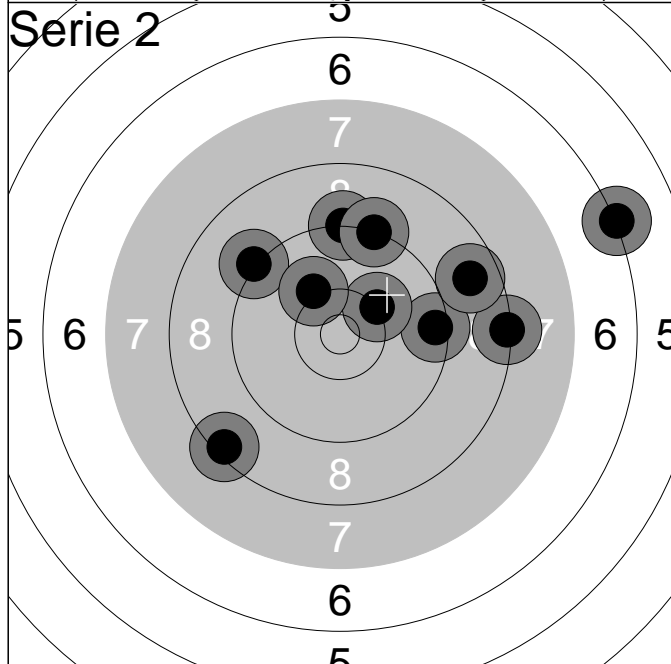

1:	8.4	↖
2:	9.4	→
3:	10.2	↗
4:	8.3	→
5:	8.7	↗
6:	9.2	↑
7:	9.2	↗
8:	6.2	↗
9:	10.1	↗
10:	9.2	↑
<b>Serie</b>		<b>86.0</b>
<b>Total</b>		<b>174.0</b>

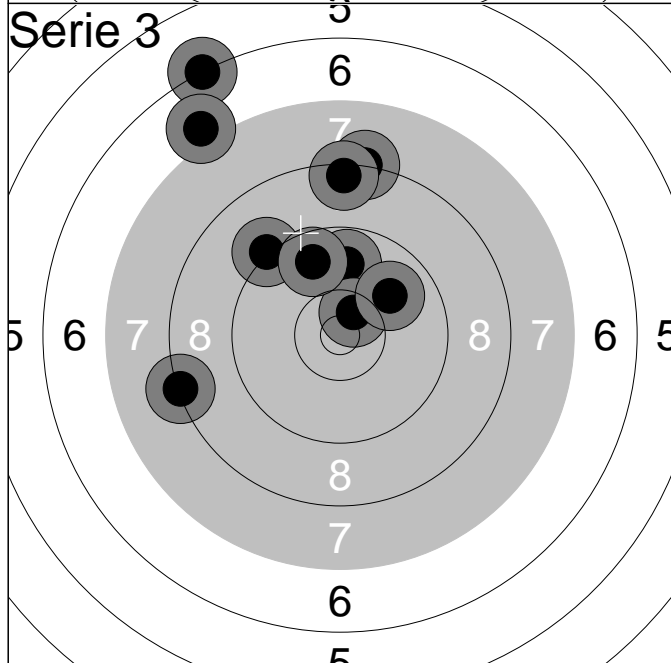

1:	8.2	↑
2:	9.8	↑
3:	10.5x	↗
4:	6.2	↑
5:	9.2	↖
6:	9.9	↗
7:	9.7	↑
8:	8.4	↑
9:	8.3	↖
10:	7.0	↖
<b>Serie</b>		<b>83.0</b>
<b>Total</b>		<b>257.0</b>

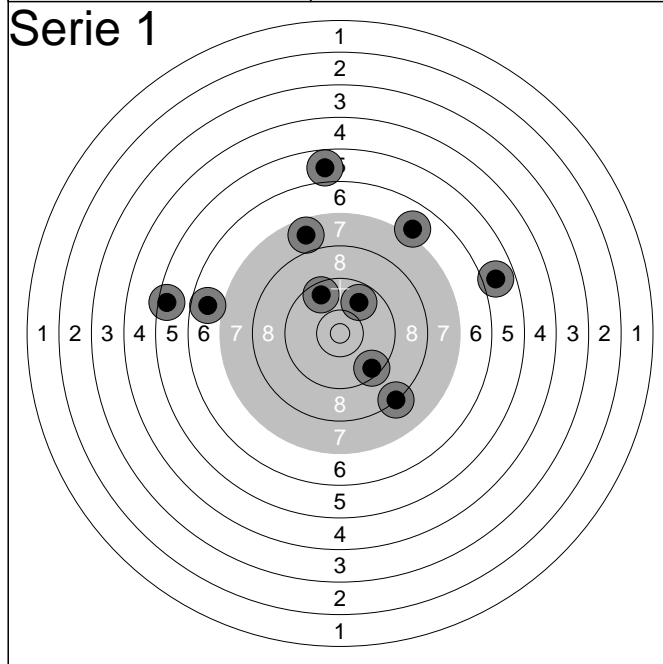

1:	6.7	←
2:	7.7	↑
3:	9.5	↓
4:	5.5	←
5:	7.0	↗
6:	9.8	↗
7:	8.2	↓
8:	9.6	↑
9:	5.8	→
10:	5.8	↑
<b>Serie</b>		<b>70.0</b>
<b>Total</b>		<b>70.0</b>

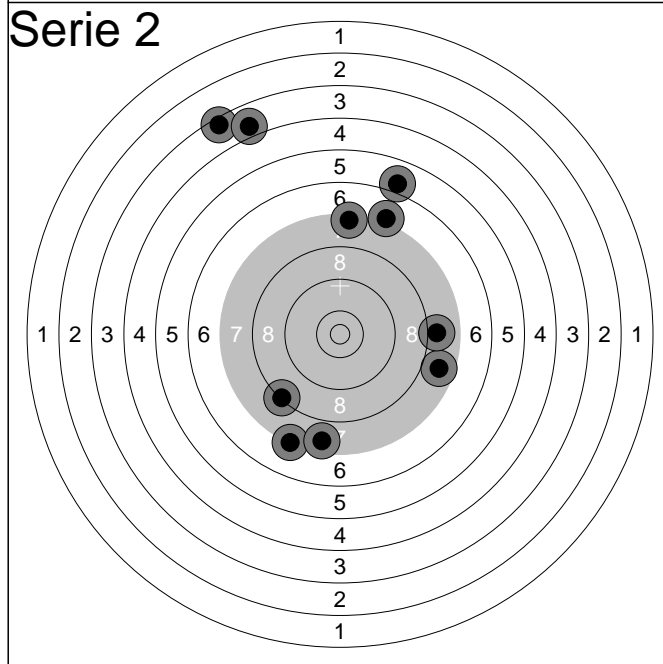

1:	7.3	↓
2:	8.3	↙
3:	3.4	↗
4:	7.4	↑
5:	7.1	↗
6:	7.6	↓
7:	3.9	↗
8:	6.0	↗
9:	7.7	→
10:	7.9	→
<b>Serie</b>		<b>62.0</b>
<b>Total</b>		<b>132.0</b>

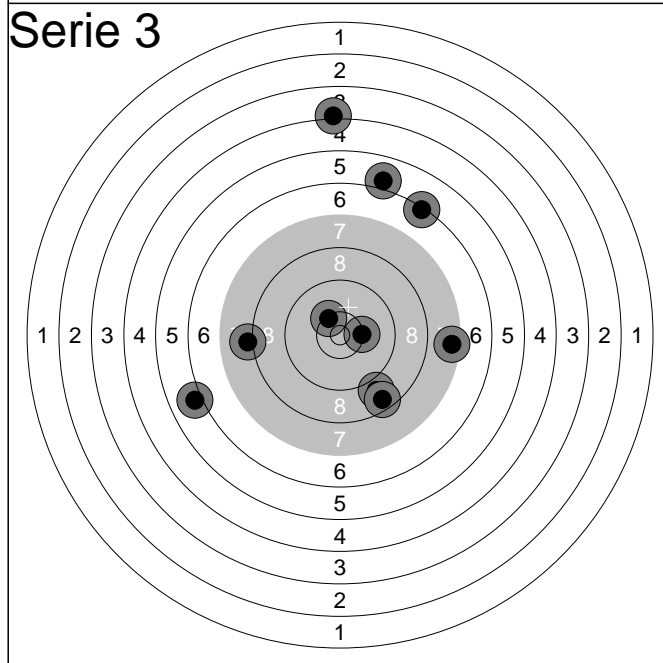

1:	10.3	↗
2:	7.5	→
3:	6.3	↗
4:	6.0	↑
5:	10.3	→
6:	4.1	↑
7:	6.0	←
8:	8.1	←
9:	8.9	↓
10:	8.5	↓
<b>Serie</b>		<b>73.0</b>
<b>Total</b>		<b>205.0</b>

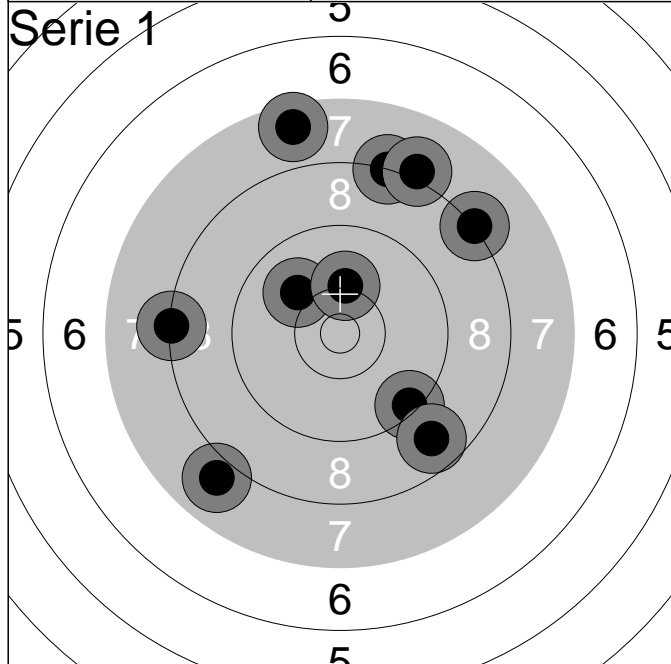

1:	8.2	↑
2:	9.4	↓
3:	10.0	↗
4:	8.3	←
5:	7.6	↑
6:	8.1	↗
7:	7.9	↙
8:	8.7	↓
9:	8.2	↗
10:	10.2	↑
<b>Serie</b>		<b>83.0</b>
<b>Total</b>		<b>83.0</b>

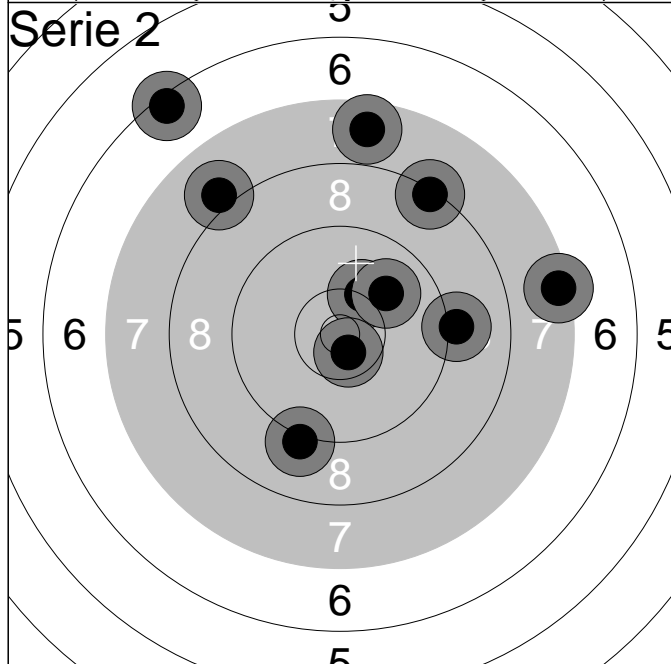

1:	9.1	↓
2:	9.1	→
3:	8.0	↗
4:	10.2	↗
5:	7.7	↑
6:	10.6x	↓
7:	8.3	↗
8:	7.4	→
9:	6.4	↗
10:	10.0	↗
<b>Serie</b>		<b>84.0</b>
<b>Total</b>		<b>167.0</b>

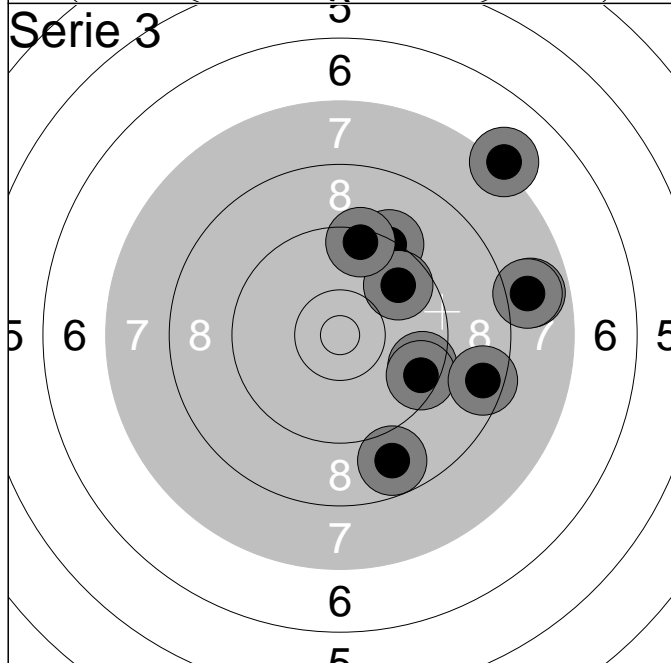

1:	8.8	↓
2:	7.8	→
3:	9.3	↗
4:	7.9	→
5:	9.7	↗
6:	9.4	↑
7:	9.5	→
8:	9.5	↓
9:	7.1	↗
10:	8.6	→
<b>Serie</b>		<b>82.0</b>
<b>Total</b>		<b>249.0</b>

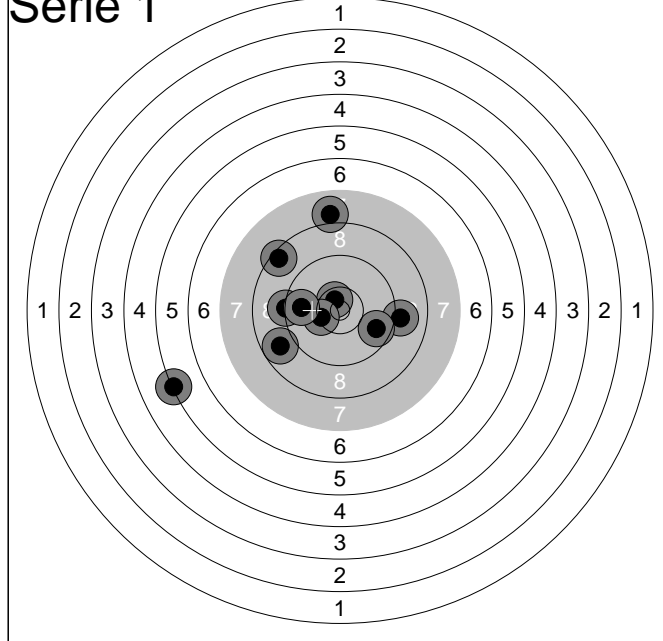

1:	9.0	→
2:	8.4	↗
3:	10.6x	↗
4:	9.3	←
5:	8.8	↙
6:	10.3	←
7:	9.8	←
8:	7.9	↑
9:	5.3	↙
10:	9.7	→
<b>Serie</b>		<b>84.0</b>
<b>Total</b>		<b>84.0</b>

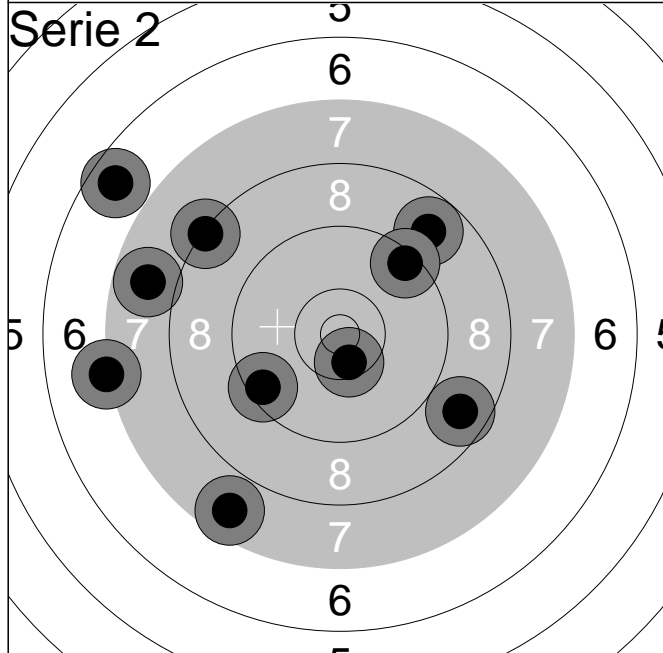

1:	9.5	↙
2:	10.5x	↓
3:	8.3	↗
4:	7.8	←
5:	8.7	↘
6:	6.6	↗
7:	8.8	↗
8:	9.4	↗
9:	7.2	←
10:	7.6	↘
<b>Serie</b>		<b>79.0</b>
<b>Total</b>		<b>163.0</b>

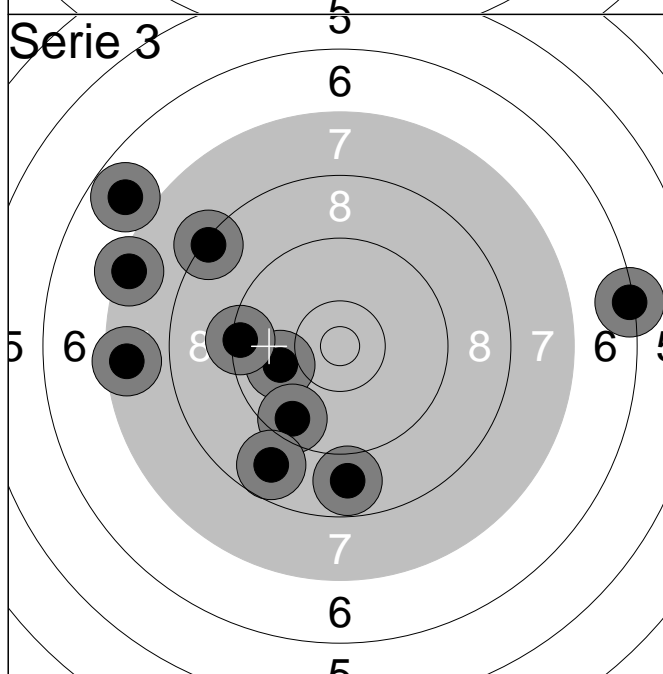

1:	8.3	↗
2:	9.9	←
3:	7.4	←
4:	7.5	←
5:	6.8	↗
6:	6.3	→
7:	9.6	↙
8:	8.8	↓
9:	9.4	←
10:	8.8	↘
<b>Serie</b>		<b>77.0</b>
<b>Total</b>		<b>240.0</b>

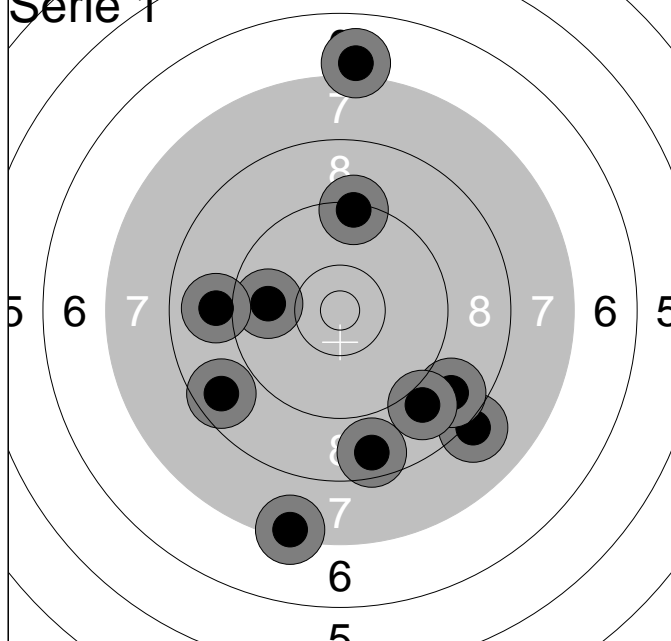

1:	9.8	←
2:	8.1	↘
3:	9.3	↑
4:	8.8	↘
5:	8.6	↘
6:	8.9	↘
7:	7.0	↑
8:	7.4	↘
9:	8.6	↙
10:	9.0	←
<b>Serie</b>		<b>81.0</b>
<b>Total</b>		<b>81.0</b>

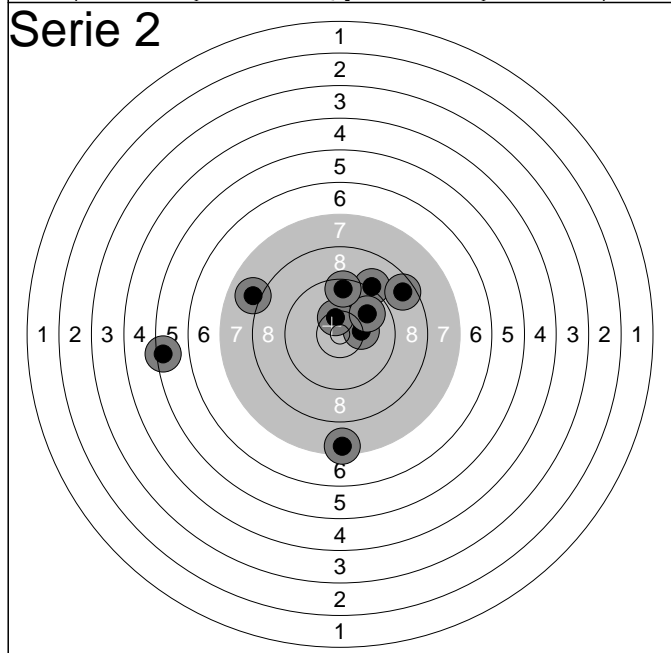

1:	10.3	↗
2:	8.0	↙
3:	10.3	→
4:	5.4	←
5:	10.4x	↑
6:	9.2	↗
7:	7.5	↘
8:	9.9	↗
9:	8.6	↗
10:	9.5	↑
<b>Serie</b>		<b>85.0</b>
<b>Total</b>		<b>166.0</b>

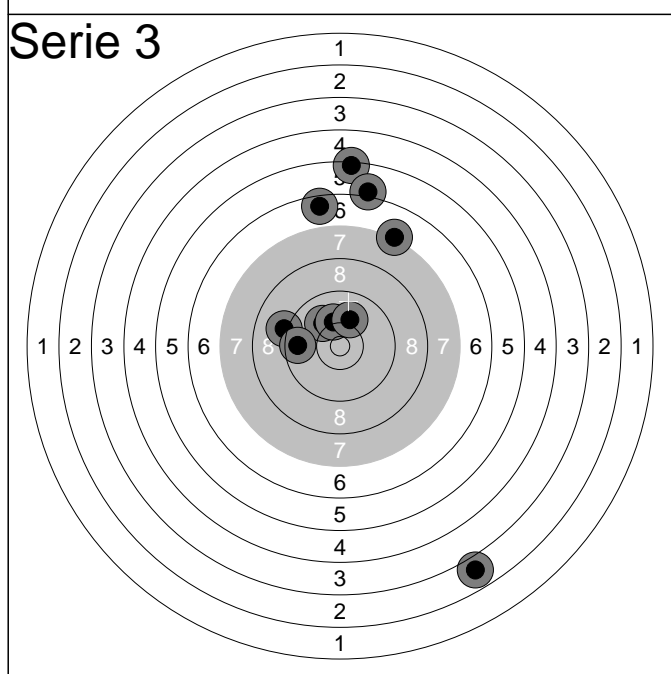

1:	10.0	↗
2:	6.6	↑
3:	5.3	↑
4:	9.1	↙
5:	10.2	↑
6:	10.1	↑
7:	9.6	←
8:	2.8	↘
9:	6.1	↑
10:	7.2	↗
<b>Serie</b>		<b>74.0</b>
<b>Total</b>		<b>240.0</b>

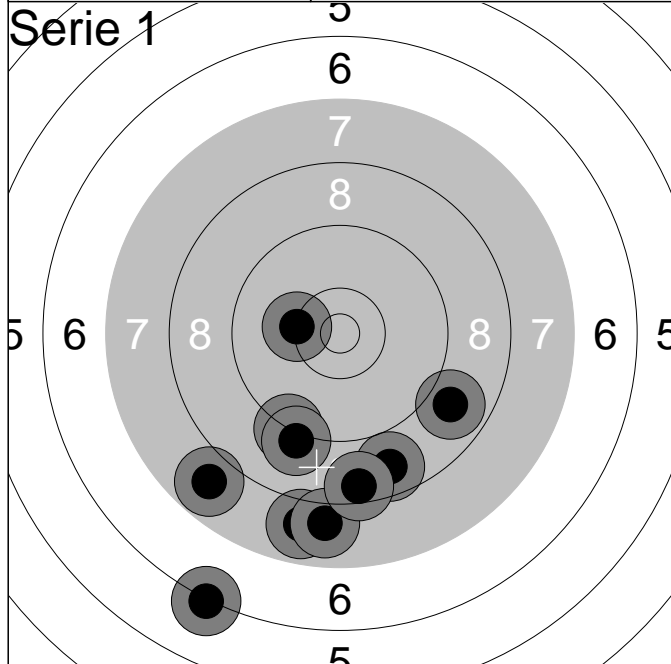

1:	7.9	↓
2:	10.2	←
3:	9.2	↙
4:	7.9	↓
5:	8.9	↘
6:	8.7	↓
7:	7.8	↙
8:	9.1	↓
9:	8.5	↓
10:	6.2	↙
<b>Serie</b>		<b>79.0</b>
<b>Total</b>		<b>79.0</b>

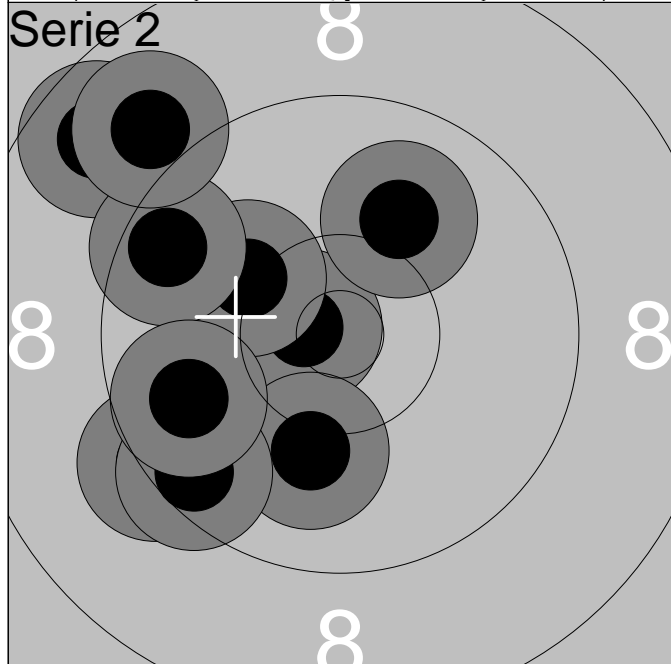

1:	10.7x	←
2:	10.2	↗
3:	8.7	↗
4:	9.6	↗
5:	10.1	↓
6:	10.0	↗
7:	8.9	↗
8:	9.3	↙
9:	9.5	↙
10:	9.8	←
<b>Serie</b>		<b>92.0</b>
<b>Total</b>		<b>171.0</b>

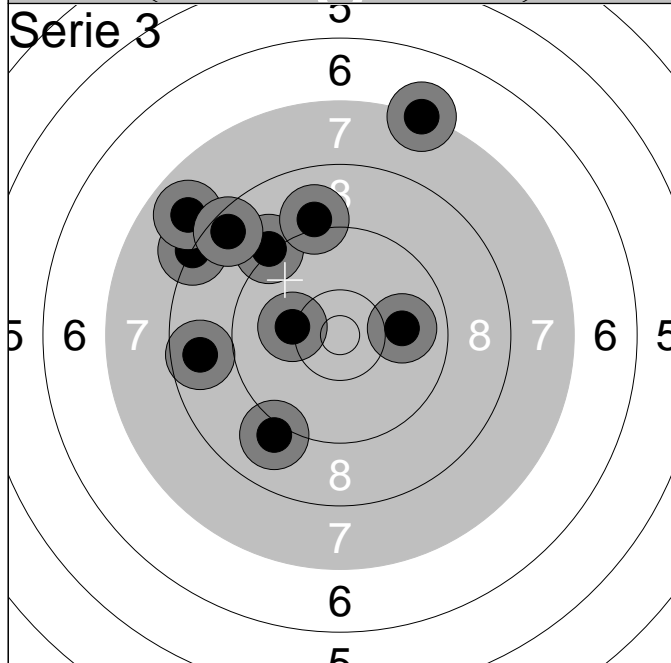

1:	8.2	↗
2:	8.7	←
3:	9.2	↗
4:	9.0	↙
5:	9.1	↑
6:	10.0	→
7:	7.2	↑
8:	10.2	←
9:	7.9	↗
10:	8.5	↗
<b>Serie</b>		<b>85.0</b>
<b>Total</b>		<b>256.0</b>



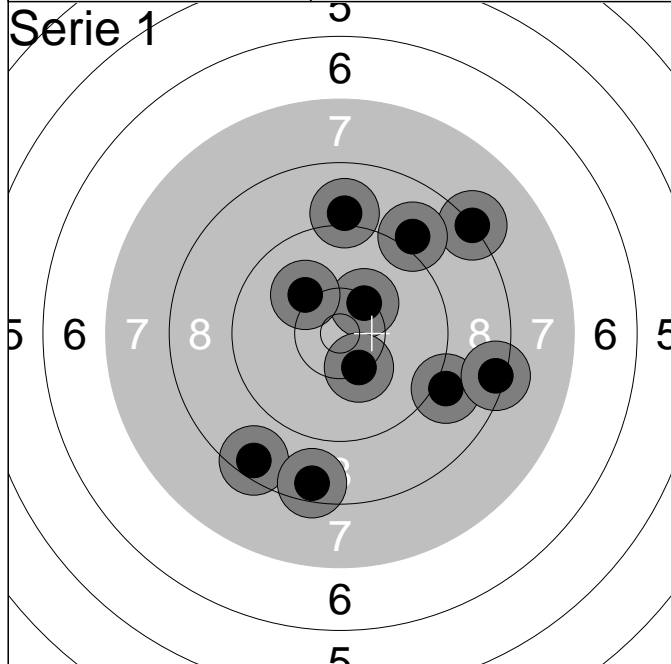

1:	9.0	↑
2:	8.5	↙
3:	10.3	↗
4:	10.3	↘
5:	9.0	→
6:	8.4	→
7:	8.2	↗
8:	8.5	↘
9:	9.0	↗
10:	10.1	↗
<b>Serie</b>		<b>89.0</b>
<b>Total</b>		<b>89.0</b>

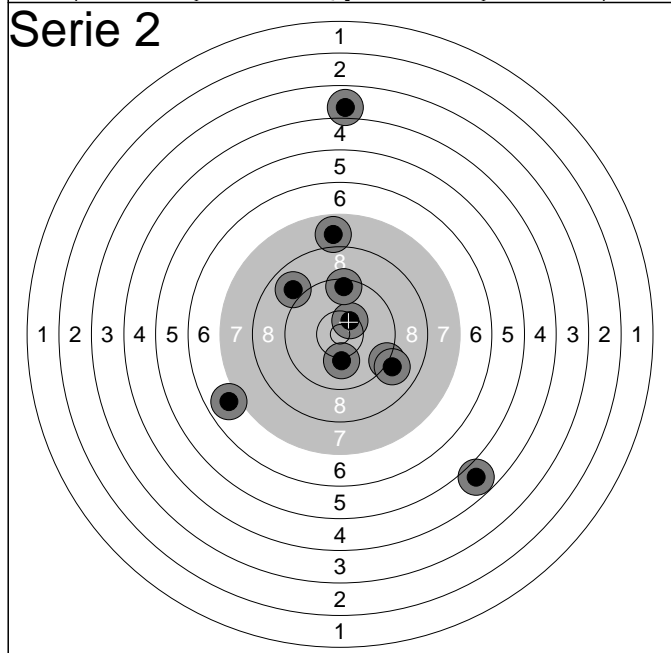

1:	3.9	↑
2:	9.3	→
3:	9.0	↘
4:	4.8	↘
5:	10.4x	↗
6:	10.1	↘
7:	6.9	↙
8:	8.9	↗
9:	9.5	↑
10:	7.8	↑
<b>Serie</b>		<b>75.0</b>
<b>Total</b>		<b>164.0</b>

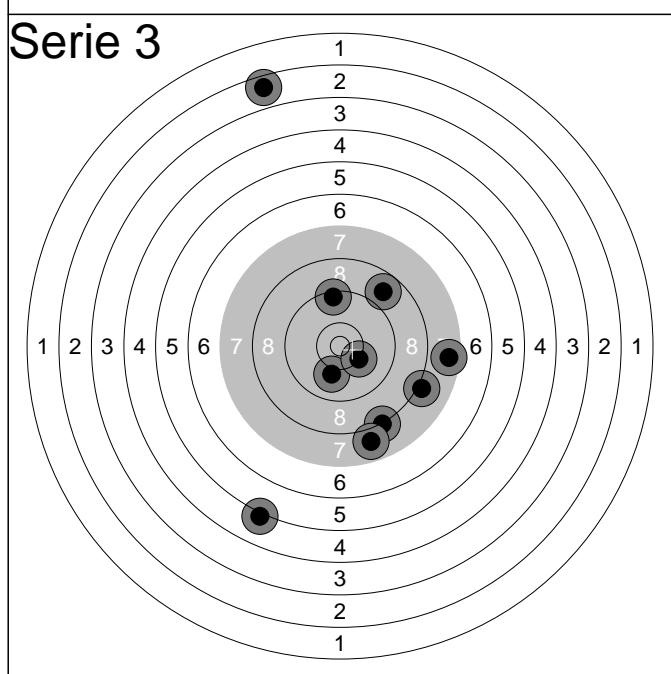

1:	8.2	↘
2:	7.5	→
3:	10.0	↘
4:	8.8	↗
5:	2.6	↑
6:	5.1	↙
7:	9.4	↑
8:	8.1	↘
9:	7.8	↘
10:	10.2	↘
<b>Serie</b>		<b>74.0</b>
<b>Total</b>		<b>238.0</b>

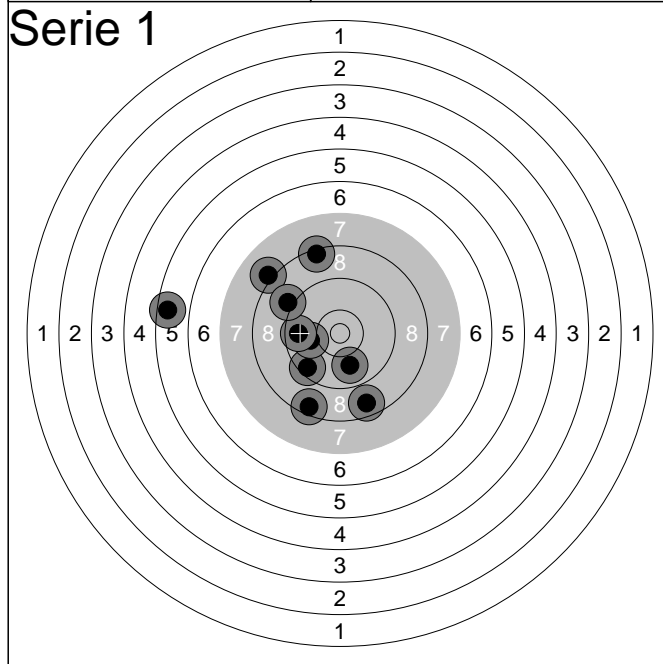

1:	8.1	↗
2:	8.4	↑
3:	9.5	↘
4:	8.5	↙
5:	9.9	↘
6:	8.6	↘
7:	10.0	←
8:	5.5	←
9:	9.7	←
10:	9.1	↗
<b>Serie</b>	<b>83.0</b>	
<b>Total</b>	<b>83.0</b>	

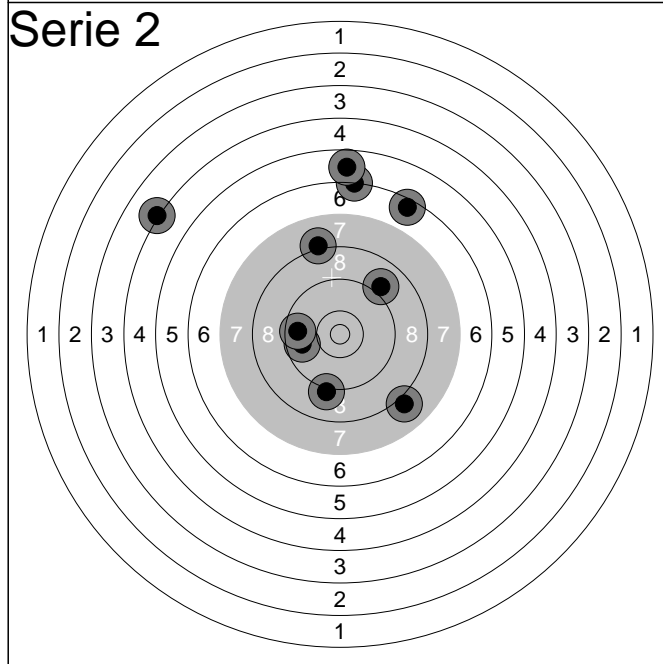

1:	9.1	↘
2:	9.7	←
3:	4.2	↗
4:	6.5	↗
5:	6.2	↑
6:	8.0	↘
7:	9.6	←
8:	9.0	↗
9:	8.1	↑
10:	5.8	↑
<b>Serie</b>	<b>73.0</b>	
<b>Total</b>	<b>156.0</b>	

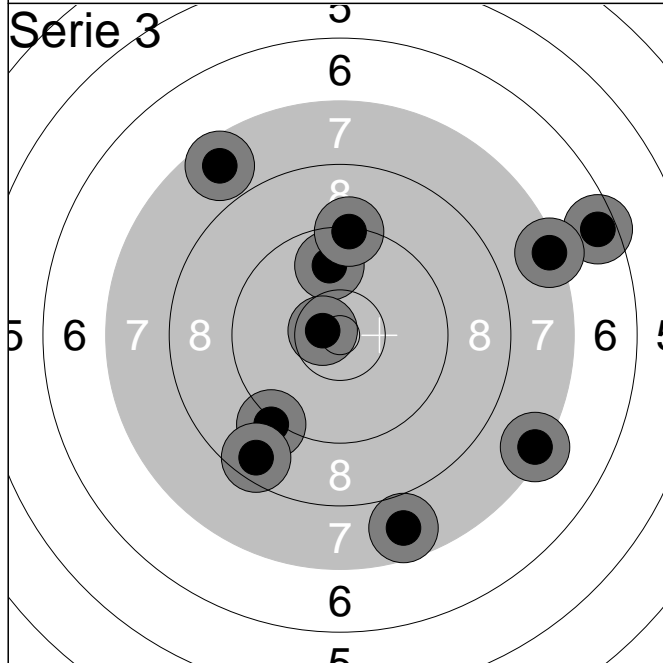

1:	7.6	↗
2:	6.5	→
3:	9.8	↑
4:	7.4	→
5:	9.3	↑
6:	9.2	↘
7:	7.4	↘
8:	8.6	↘
9:	10.7x	←
10:	7.7	↘
<b>Serie</b>	<b>79.0</b>	
<b>Total</b>	<b>235.0</b>	

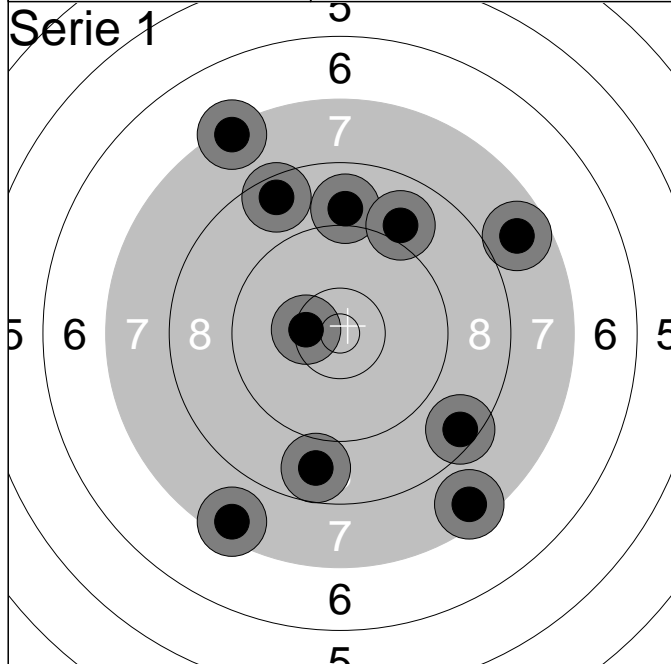

1:	8.8	↓
2:	7.5	↓
3:	7.5	↓
4:	8.5	↓
5:	8.5	↑
6:	9.0	↑
7:	7.3	↑
8:	10.4x	←
9:	9.0	↗
10:	7.7	↗
<b>Serie</b>		<b>80.0</b>
<b>Total</b>		<b>80.0</b>

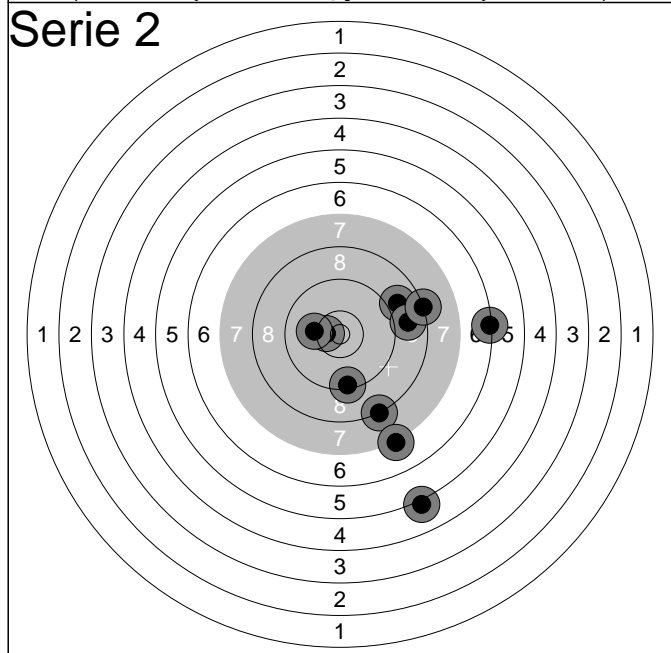

1:	10.5x	←
2:	10.1	←
3:	9.4	↓
4:	8.2	↓
5:	8.9	↗
6:	6.3	→
7:	7.2	↓
8:	5.1	↓
9:	8.8	→
10:	8.2	→
<b>Serie</b>		<b>79.0</b>
<b>Total</b>		<b>159.0</b>

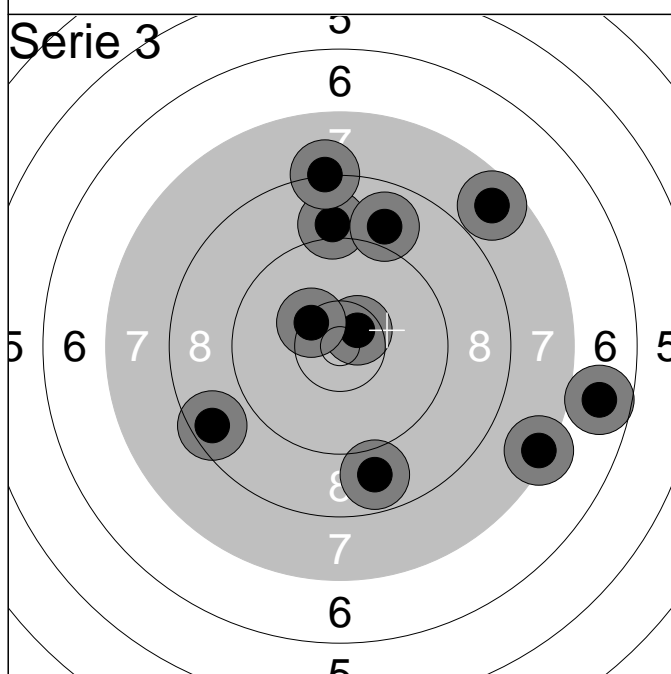

1:	7.6	↗
2:	9.0	↑
3:	10.6x	↗
4:	8.9	↑
5:	8.6	←
6:	6.7	→
7:	7.4	↘
8:	8.2	↑
9:	10.3	↗
10:	8.8	↓
<b>Serie</b>		<b>81.0</b>
<b>Total</b>		<b>240.0</b>

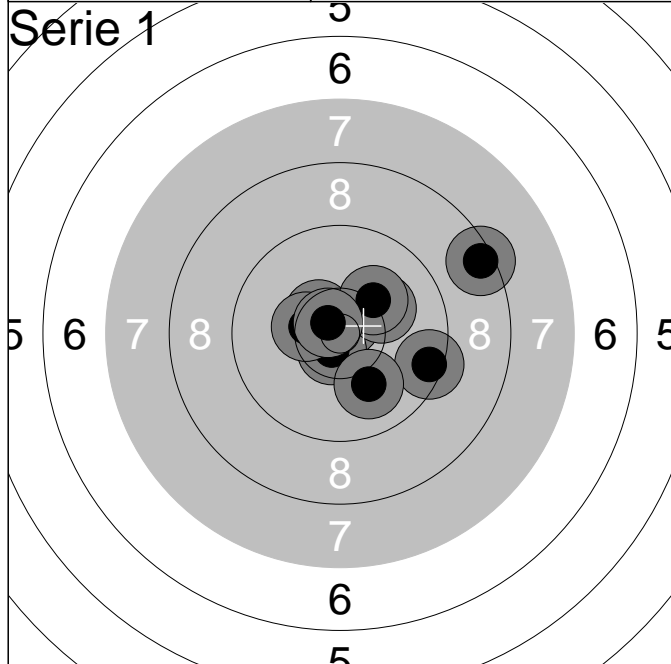

1:	10.7x	↗
2:	10.6x	↘
3:	10.2	↗
4:	10.5x	↗
5:	9.4	→
6:	10.4x	↖
7:	10.0	↘
8:	8.4	↗
9:	10.2	↗
10:	10.7x	↖

Serie	97.0
Total	97.0

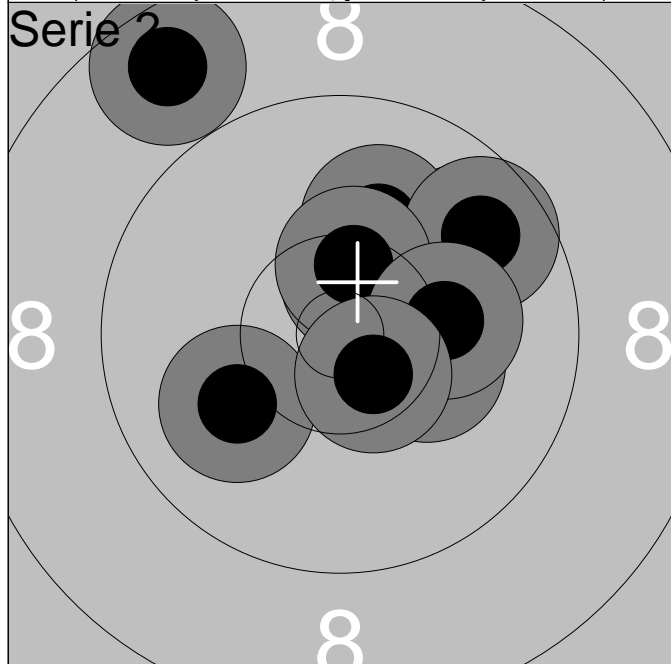

1:	10.1	↖
2:	8.7	↗
3:	10.3	→
4:	9.8	↗
5:	10.1	↗
6:	10.5x	↗
7:	9.7	↗
8:	10.4x	↗
9:	10.2	→
10:	10.6x	↘

Serie	96.0
Total	193.0

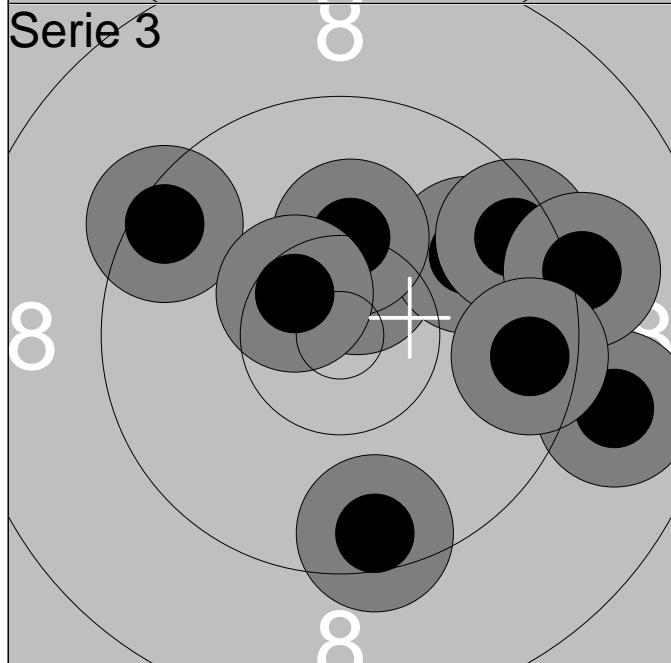

1:	9.5	↖
2:	8.9	→
3:	10.5x	↗
4:	9.9	↗
5:	10.2	↗
6:	9.5	↗
7:	9.1	→
8:	10.5x	↗
9:	9.6	→
10:	9.5	↘

Serie	92.0
Total	285.0

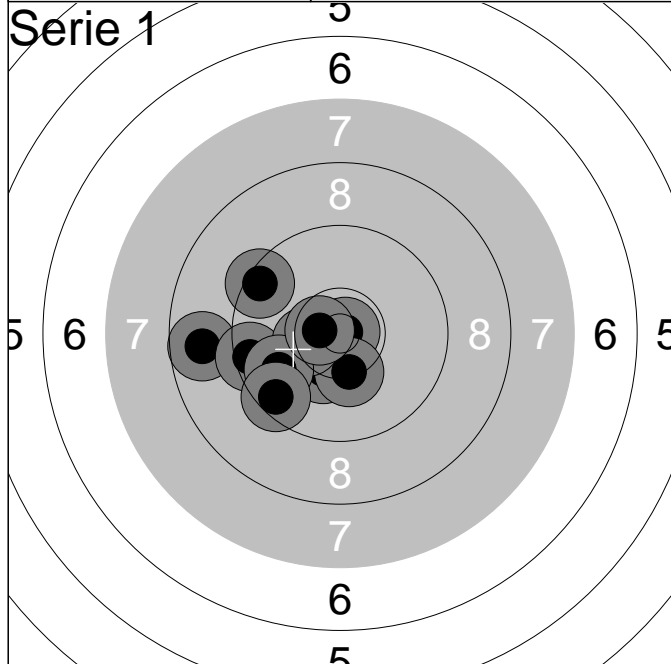

1:	10.8x	→
2:	10.3	↓
3:	8.8	←
4:	10.3	↓
5:	9.5	←
6:	10.4x	←
7:	9.4	↗
8:	9.8	↙
9:	10.6x	←
10:	9.5	↙
<b>Serie</b>		<b>94.0</b>
<b>Total</b>		<b>94.0</b>

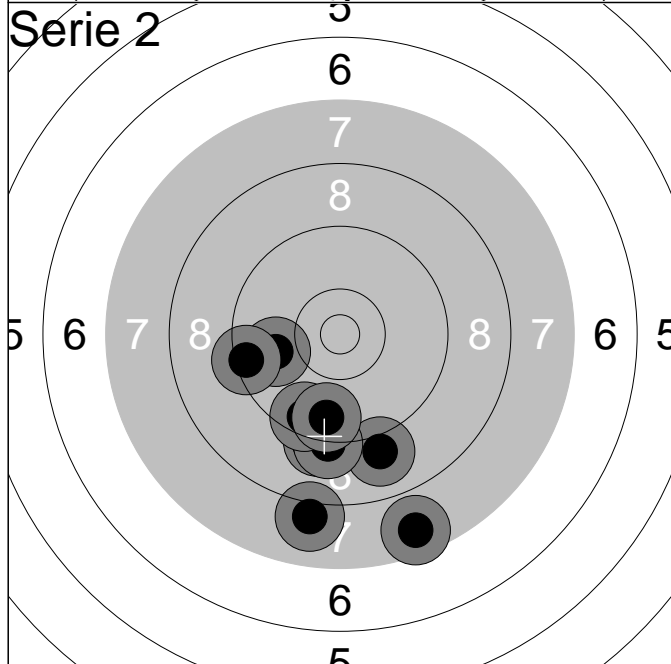

1:	9.2	↓
2:	9.9	←
3:	9.0	↓
4:	9.3	↓
5:	7.6	↓
6:	8.0	↓
7:	9.2	↓
8:	9.5	↓
9:	9.6	↓
10:	9.4	←
<b>Serie</b>		<b>87.0</b>
<b>Total</b>		<b>181.0</b>

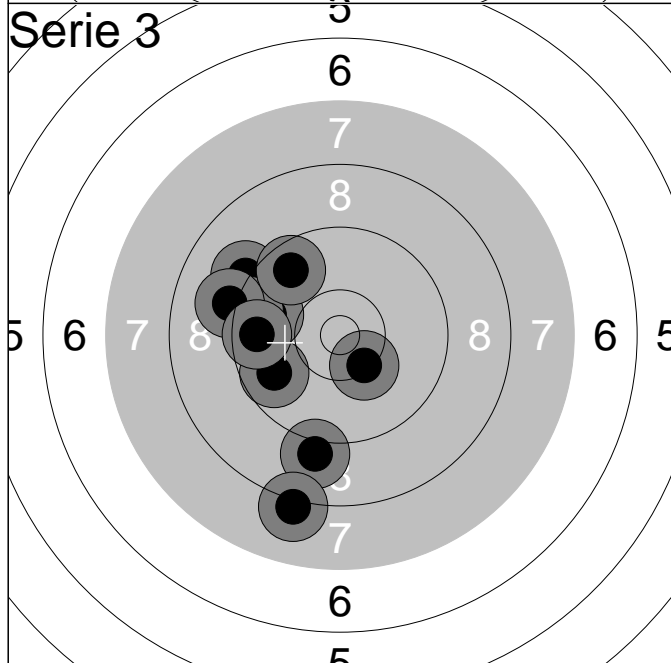

1:	9.2	↗
2:	9.8	←
3:	9.4	←
4:	9.6	↗
5:	10.3	↓
6:	9.7	←
7:	9.0	↓
8:	9.1	←
9:	8.1	↓
10:	9.6	←
<b>Serie</b>		<b>90.0</b>
<b>Total</b>		<b>271.0</b>

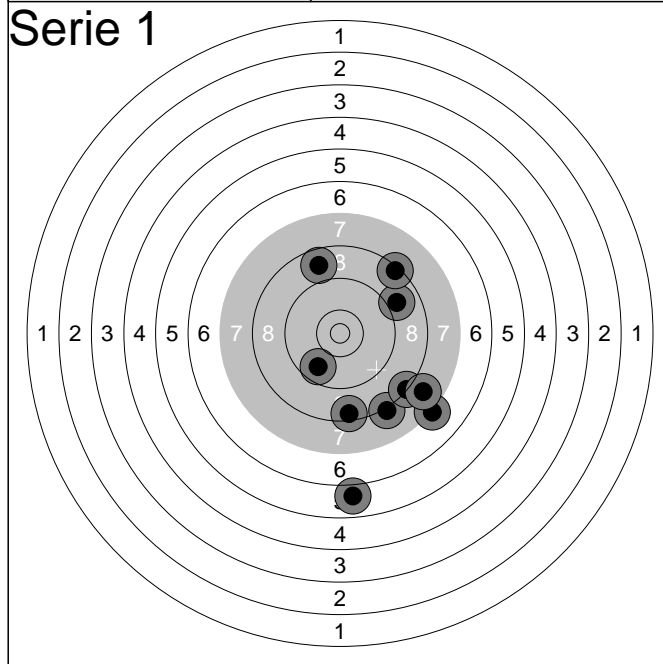

1:	8.9	↗
2:	5.9	↓
3:	8.2	↘
4:	8.4	↓
5:	8.2	↘
6:	7.2	↘
7:	8.4	↗
8:	7.8	↘
9:	8.7	↗
10:	9.7	↘
<b>Serie</b>		<b>76.0</b>
<b>Total</b>		<b>76.0</b>

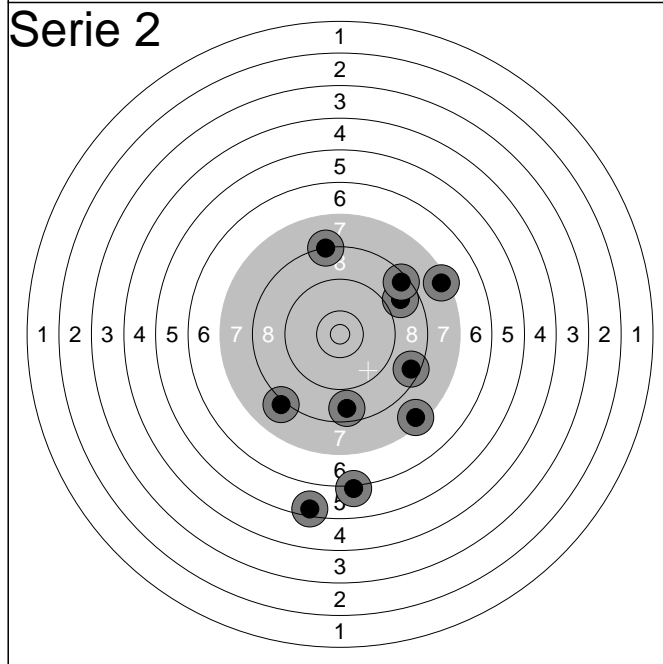

1:	7.4	↗
2:	8.8	↗
3:	8.1	↘
4:	5.4	↓
5:	6.2	↓
6:	8.4	↗
7:	8.2	↗
8:	7.5	↘
9:	8.5	↘
10:	8.6	↓
<b>Serie</b>		<b>73.0</b>
<b>Total</b>		<b>149.0</b>

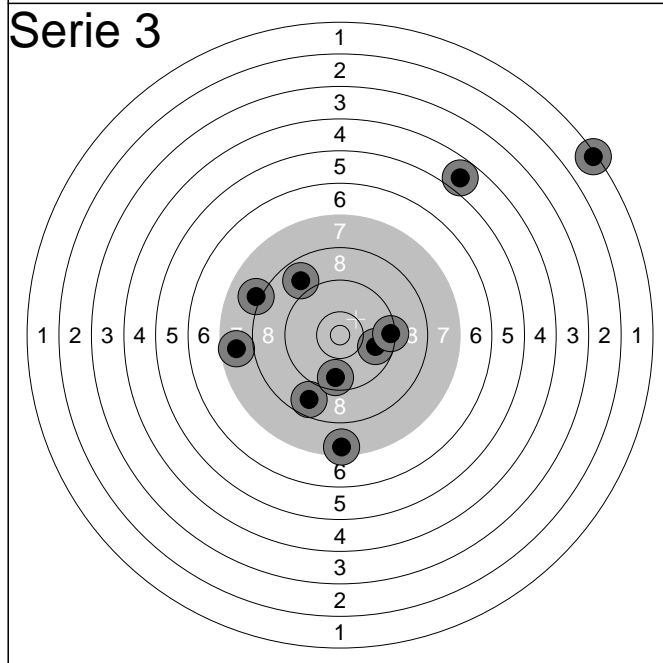

1:	4.8	↗
2:	8.1	↗
3:	7.5	↓
4:	9.8	→
5:	8.9	↗
6:	8.7	↘
7:	9.4	→
8:	7.7	←
9:	9.6	↓
10:	1.3	↗
<b>Serie</b>		<b>70.0</b>
<b>Total</b>		<b>219.0</b>

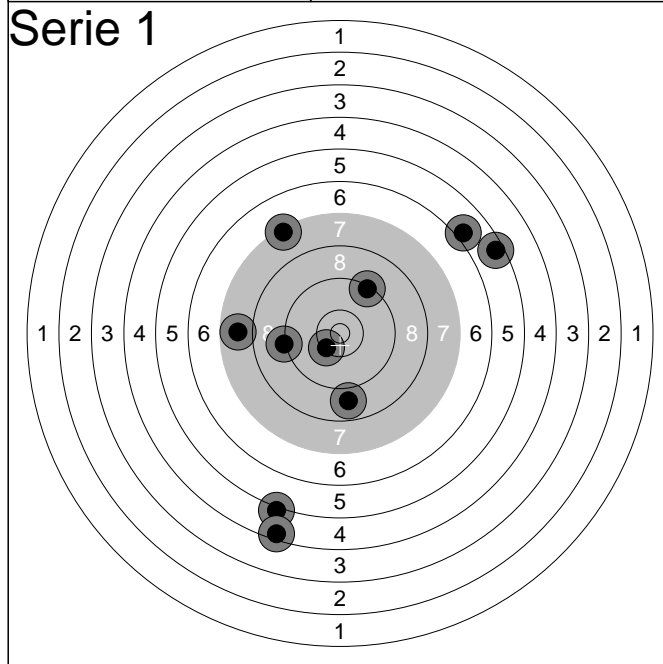

1:	7.8	←
2:	9.3	↗
3:	7.3	↗
4:	10.3	↙
5:	6.0	↗
6:	8.8	↓
7:	9.2	←
8:	5.4	↗
9:	5.1	↓
10:	4.4	↓
<b>Serie</b>		<b>70.0</b>
<b>Total</b>		<b>70.0</b>

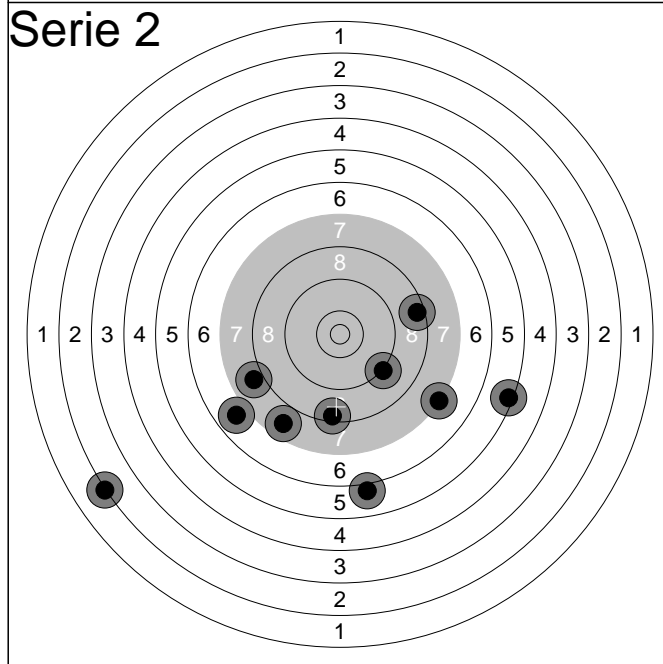

1:	7.7	↙
2:	2.2	←
3:	8.4	↓
4:	6.0	↓
5:	7.3	↘
6:	7.9	←
7:	9.2	↘
8:	5.3	→
9:	6.9	↙
10:	8.4	→
<b>Serie</b>		<b>65.0</b>
<b>Total</b>		<b>135.0</b>

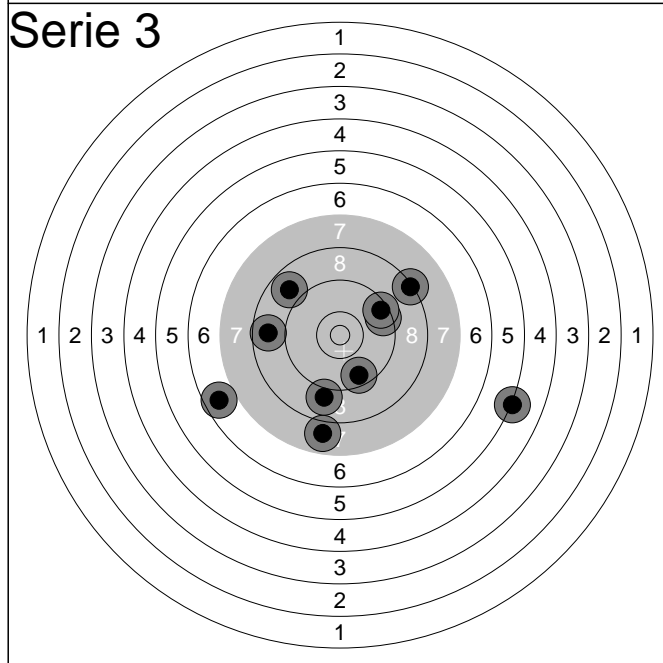

1:	8.8	↗
2:	5.2	→
3:	7.9	↓
4:	9.5	→
5:	9.0	↓
6:	8.7	←
7:	9.5	↗
8:	8.3	↗
9:	6.7	↙
10:	9.6	↓
<b>Serie</b>		<b>78.0</b>
<b>Total</b>		<b>213.0</b>

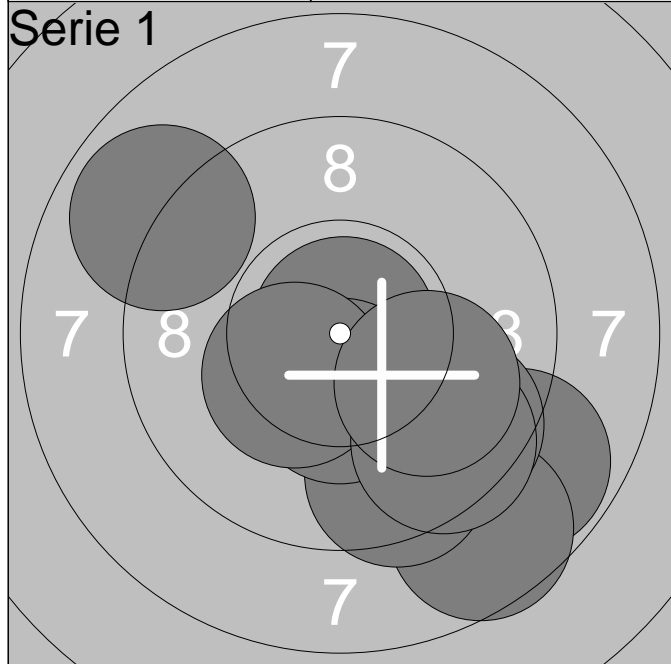

1:	10.9x	↗
2:	8.8	↘
3:	8.6	↘
4:	9.5	↘
5:	9.5	↘
6:	10.4x	↓
7:	10.3x	↙
8:	9.5	↘
9:	8.9	↗
10:	9.9	↘
<b>Serie</b>		<b>90.0</b>
<b>Total</b>		<b>90.0</b>

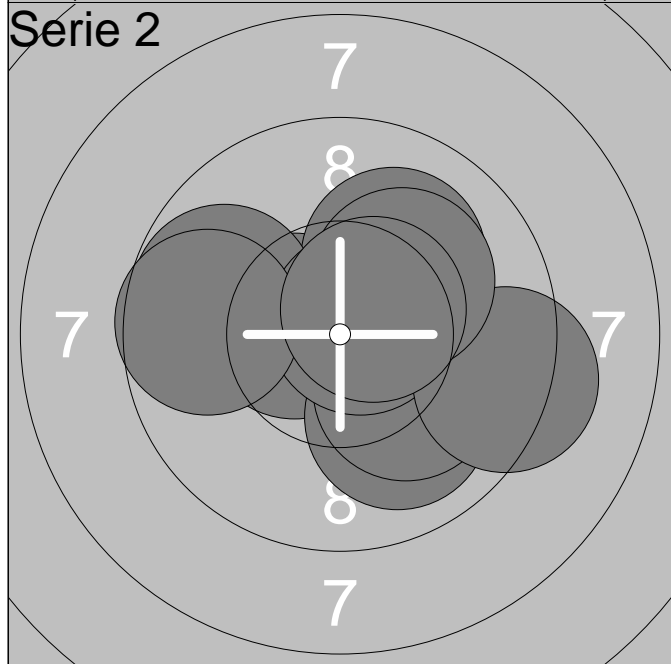

1:	10.5x	←
2:	9.9	↘
3:	10.0	↗
4:	10.1	↘
5:	9.8	←
6:	10.7x	↗
7:	9.7	←
8:	9.3	→
9:	10.1	↗
10:	10.5x	↗
<b>Serie</b>		<b>96.0</b>
<b>Total</b>		<b>186.0</b>

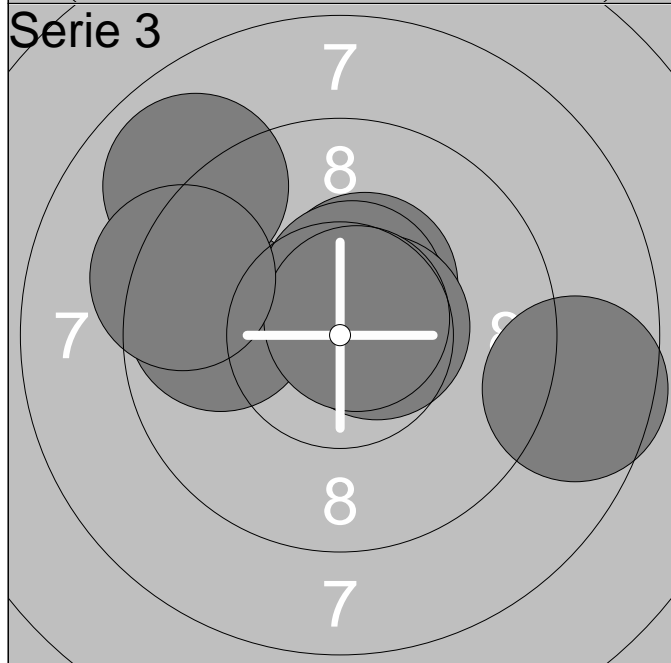

1:	10.5x	↗
2:	9.8	←
3:	10.4x	↗
4:	8.9	↗
5:	10.6x	↗
6:	10.5x	↗
7:	10.5x	→
8:	10.7x	↗
9:	9.3	←
10:	8.6	→
<b>Serie</b>		<b>94.0</b>
<b>Total</b>		<b>280.0</b>



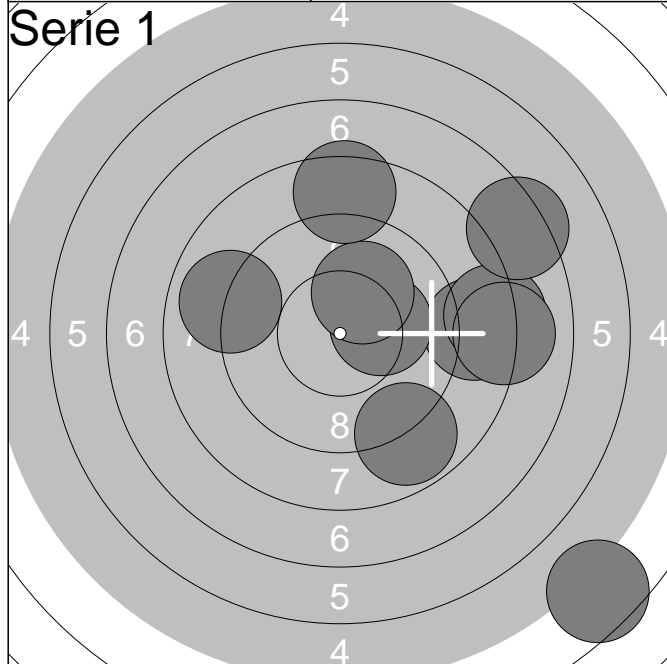

1:	8.8	↘
2:	8.6	→
3:	8.2	→
4:	10.2x	→
5:	4.5	↘
6:	8.1	→
7:	8.9	↙
8:	7.3	↗
9:	10.1	↗
10:	8.5	↑
<b>Serie</b>		<b>79.0</b>
<b>Total</b>		<b>79.0</b>

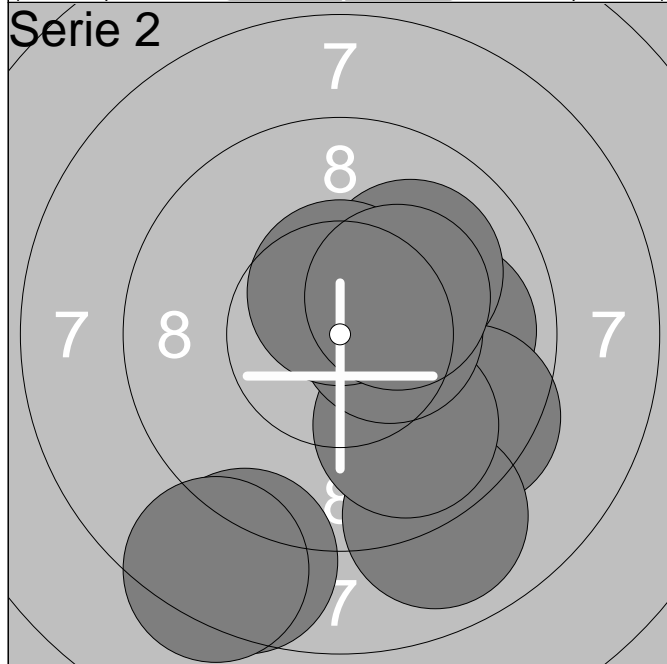

1:	9.9	→
2:	8.5	↘
3:	10.0	↗
4:	9.5	↘
5:	9.0	↘
6:	9.8	↘
7:	8.3	↘
8:	10.5x	→
9:	10.5x	↑
10:	10.2x	↗
<b>Serie</b>		<b>92.0</b>
<b>Total</b>		<b>171.0</b>

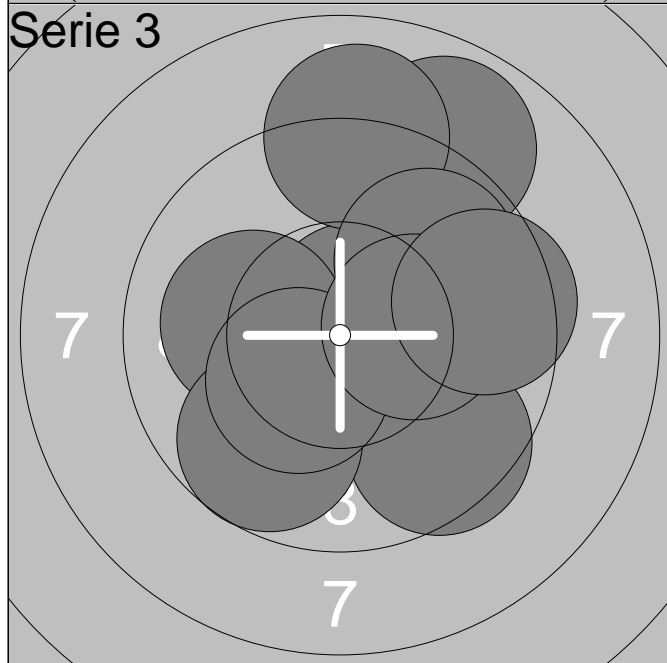

1:	8.8	↗
2:	10.7x	↗
3:	9.5	↘
4:	9.0	↑
5:	10.1	↙
6:	9.7	↘
7:	9.8	↗
8:	10.3x	↘
9:	10.2x	→
10:	9.5	→
<b>Serie</b>		<b>93.0</b>
<b>Total</b>		<b>264.0</b>

Lag <b>2</b>	Skive <b>4</b>	<b>Malin Brække</b>		
Luft		Vestre Bærum Salongskytterl.	R12	
16.04.2015		Landsstevnet rekrutt 2015	LS Rekrutt 2015	
<b>Serie 1</b> 		1:	9.5	↑
		2:	8.3	↖
		3:	8.8	↖
		4:	10.0	→
		5:	10.7x	→
		6:	10.0	←
		7:	9.8	↘
		8:	9.0	←
		9:	10.5x	↗
		10:	9.5	↗
				<b>Serie</b>
		<b>Total</b>	<b>92.0</b>	
<b>Serie 2</b> 		1:	10.2x	↙
		2:	8.1	←
		3:	10.3x	↑
		4:	9.6	↑
		5:	9.9	↑
		6:	10.2x	↙
		7:	9.5	↑
		8:	10.3x	↗
		9:	9.7	↑
		10:	9.3	↘
				<b>Serie</b>
		<b>Total</b>	<b>185.0</b>	
<b>Serie 3</b> 		1:	9.1	←
		2:	8.0	→
		3:	10.0	↗
		4:	9.0	←
		5:	10.8x	↑
		6:	10.4x	↗
		7:	7.9	←
		8:	9.5	↖
		9:	10.3x	↑
		10:	8.4	↖
				<b>Serie</b>
		<b>Total</b>	<b>275.0</b>	

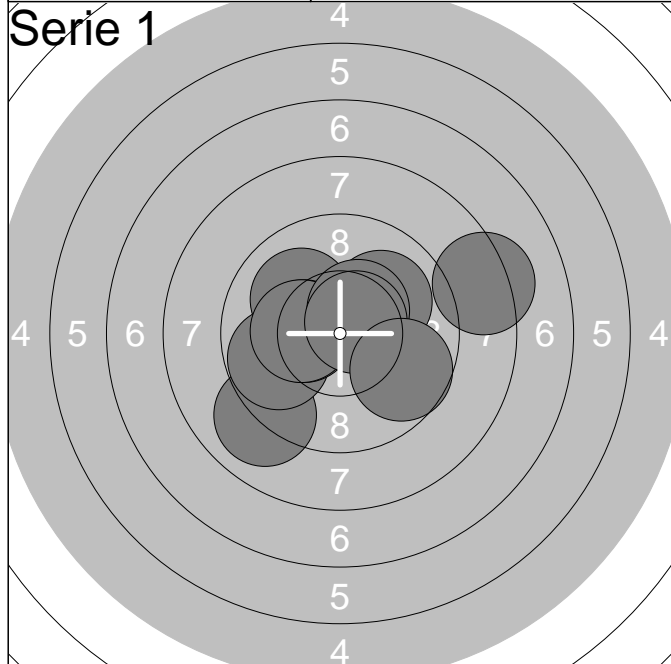

1:	8.3	→
2:	10.0	↗
3:	10.0	↖
4:	9.0	↘
5:	9.8	←
6:	10.3x	←
7:	10.3x	←
8:	10.4x	↗
9:	10.6x	↗
10:	9.7	↘
<b>Serie</b>		<b>95.0</b>
<b>Total</b>		<b>95.0</b>

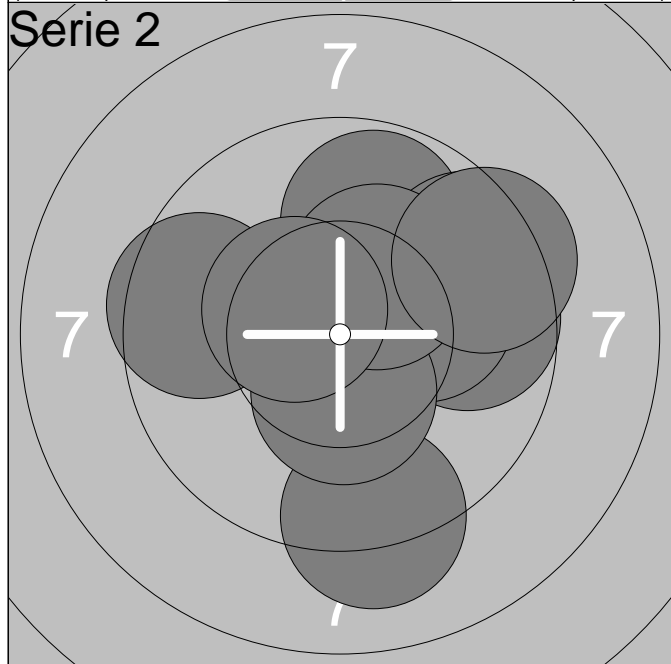

1:	9.5	←
2:	9.7	→
3:	9.1	↓
4:	9.8	↑
5:	9.5	↗
6:	10.1	→
7:	10.4x	↓
8:	10.3x	↗
9:	9.3	↗
10:	10.4x	↖
<b>Serie</b>		<b>94.0</b>
<b>Total</b>		<b>189.0</b>

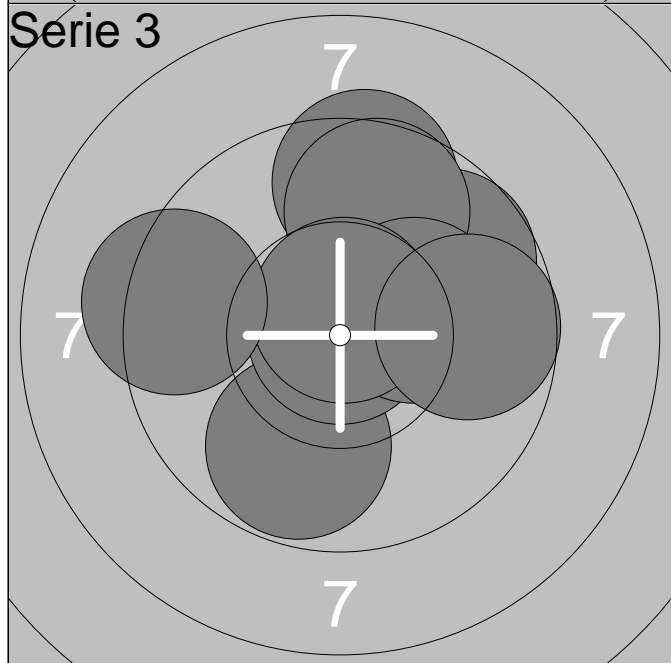

1:	9.8	↗
2:	9.7	↗
3:	9.4	↑
4:	9.7	↑
5:	9.8	↓
6:	10.9x	↑
7:	10.2x	→
8:	10.7x	↑
9:	9.3	←
10:	9.7	→
<b>Serie</b>		<b>93.0</b>
<b>Total</b>		<b>282.0</b>

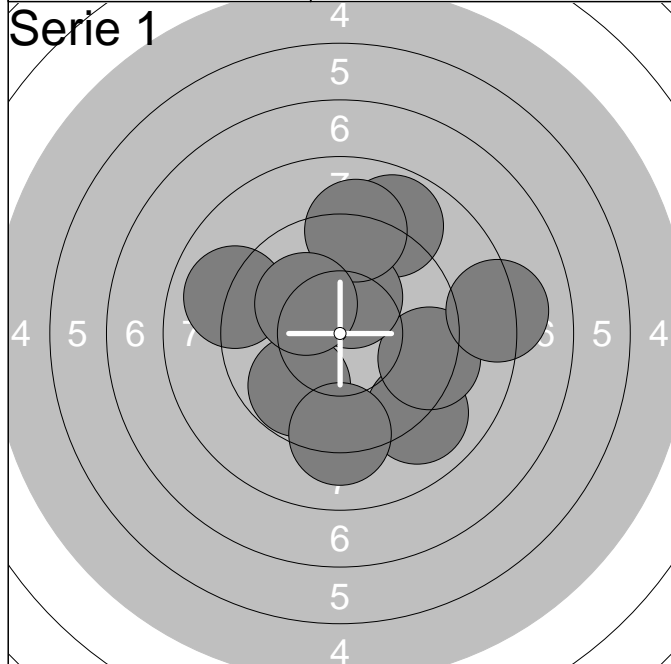

1:	9.0	↘
2:	8.8	↗
3:	9.3	→
4:	10.3x	↗
5:	9.8	↘
6:	9.2	↓
7:	9.0	↖
8:	9.1	↑
9:	8.2	→
10:	10.1	↗
<b>Serie</b>		<b>90.0</b>
<b>Total</b>		<b>90.0</b>

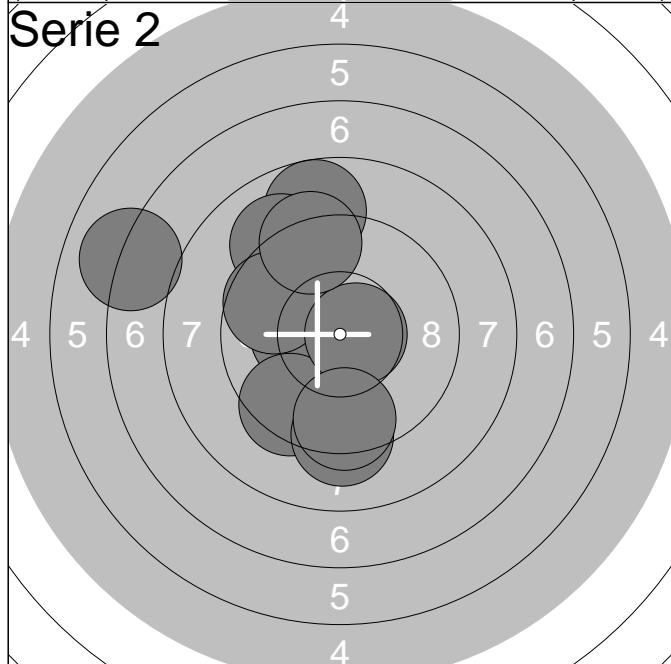

1:	10.2x	←
2:	9.4	↘
3:	8.7	↗
4:	9.1	↗
5:	9.2	↓
6:	9.6	↖
7:	10.7x	→
8:	7.0	↖
9:	9.2	↑
10:	9.5	↓
<b>Serie</b>		<b>89.0</b>
<b>Total</b>		<b>179.0</b>

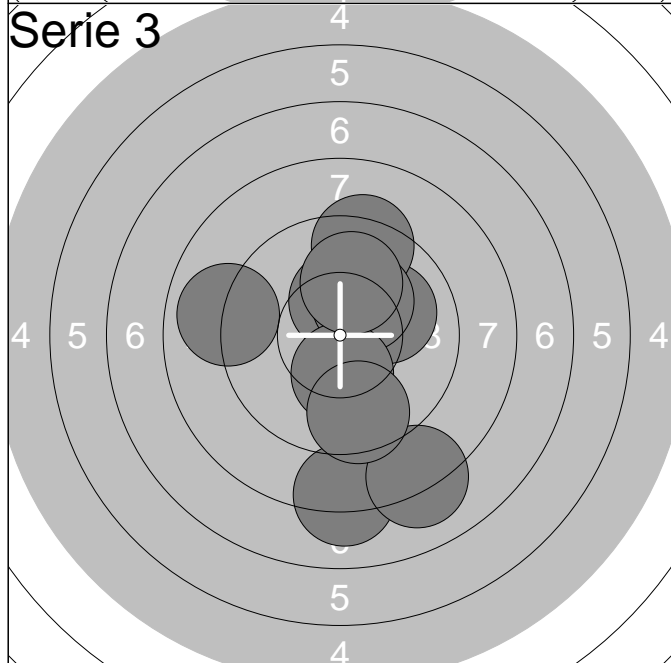

1:	10.0	↗
2:	8.9	←
3:	8.1	↓
4:	10.3x	↑
5:	9.3	↗
6:	8.1	↘
7:	10.2x	↗
8:	10.3x	↓
9:	9.5	↘
10:	10.0	↑
<b>Serie</b>		<b>92.0</b>
<b>Total</b>		<b>271.0</b>

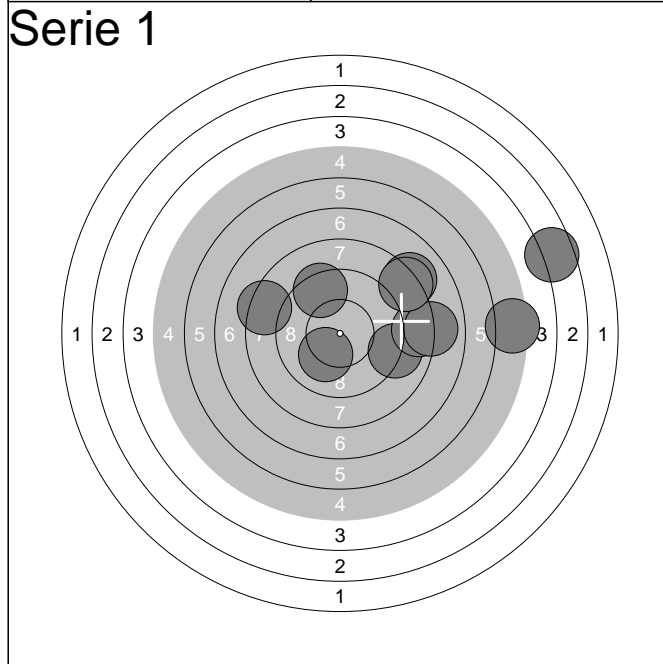

1:	9.0	➔
2:	9.4	↗
3:	5.3	➔
4:	8.0	↗
5:	8.4	➔
6:	8.3	↖
7:	3.6	➔
8:	8.0	➔
9:	8.2	↗
10:	10.1	↙
<b>Serie</b>		<b>76.0</b>
<b>Total</b>		<b>76.0</b>

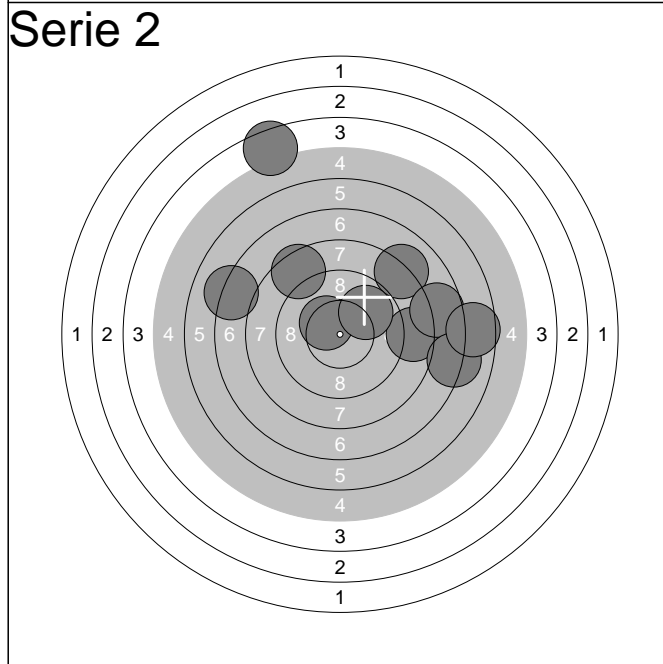

1:	8.1	↗
2:	10.3x	↖
3:	8.5	➔
4:	7.7	➔
5:	7.1	➔
6:	4.4	↖
7:	6.6	➔
8:	7.1	↖
9:	9.8	↗
10:	8.5	↖
<b>Serie</b>		<b>74.0</b>
<b>Total</b>		<b>150.0</b>

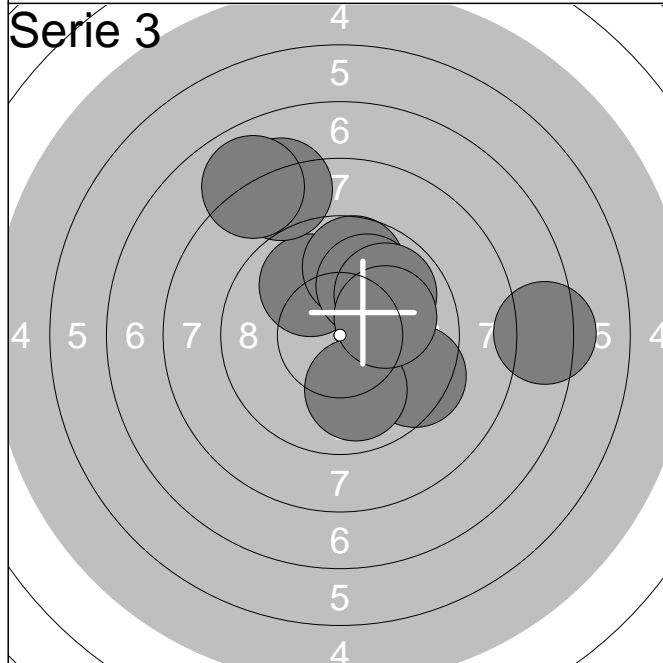

1:	9.9	↖
2:	9.4	➔
3:	9.7	↖
4:	9.9	↙
5:	8.2	↖
6:	7.9	↖
7:	9.9	↖
8:	9.9	↗
9:	10.1	➔
10:	7.3	➔
<b>Serie</b>		<b>86.0</b>
<b>Total</b>		<b>236.0</b>

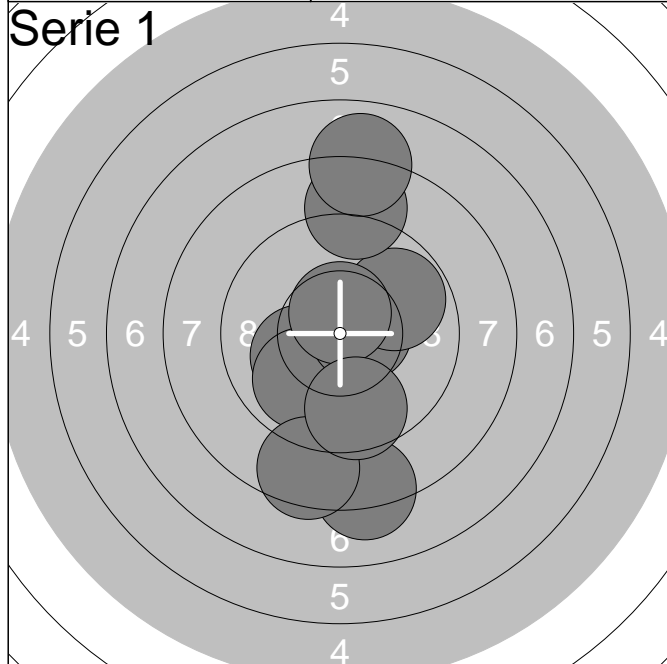

1:	10.1	↙
2:	9.9	↙
3:	10.6x	→
4:	9.8	↗
5:	8.7	↑
6:	8.2	↓
7:	10.6x	↑
8:	8.5	↓
9:	9.6	↓
10:	7.9	↑
<b>Serie</b>		<b>88.0</b>
<b>Total</b>		<b>88.0</b>

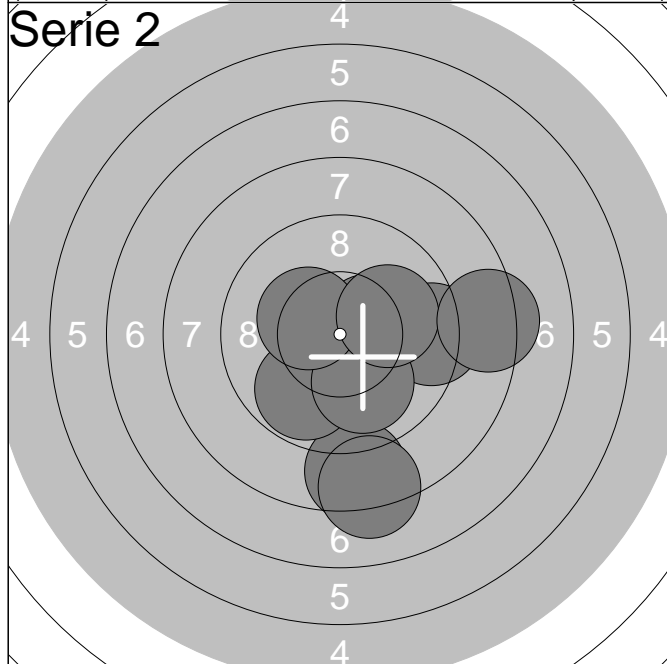

1:	10.2x	↓
2:	9.3	→
3:	8.5	↓
4:	10.4x	→
5:	8.2	↓
6:	9.8	↙
7:	10.0	↓
8:	10.3x	↖
9:	10.0	→
10:	8.3	→
<b>Serie</b>		<b>92.0</b>
<b>Total</b>		<b>180.0</b>

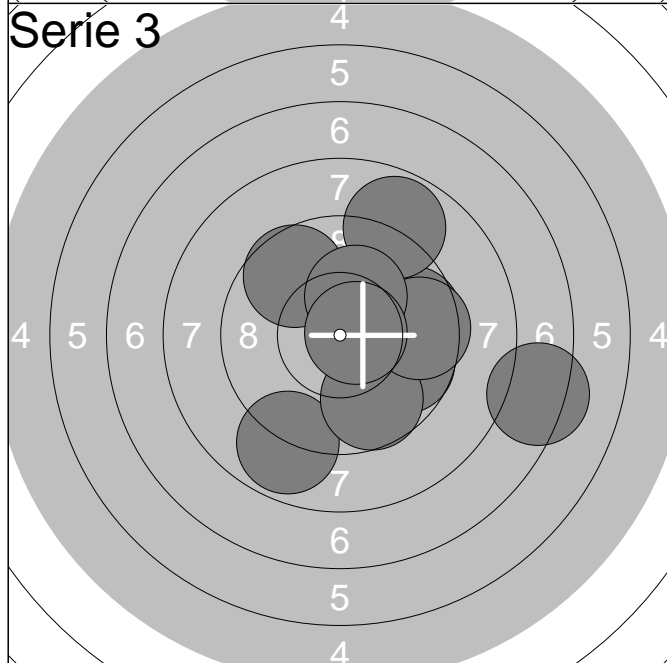

1:	9.6	→
2:	8.8	↙
3:	9.7	↘
4:	9.7	↙
5:	8.8	↗
6:	9.6	↗
7:	9.5	→
8:	10.2x	↑
9:	7.3	↘
10:	10.7x	→
<b>Serie</b>		<b>88.0</b>
<b>Total</b>		<b>268.0</b>

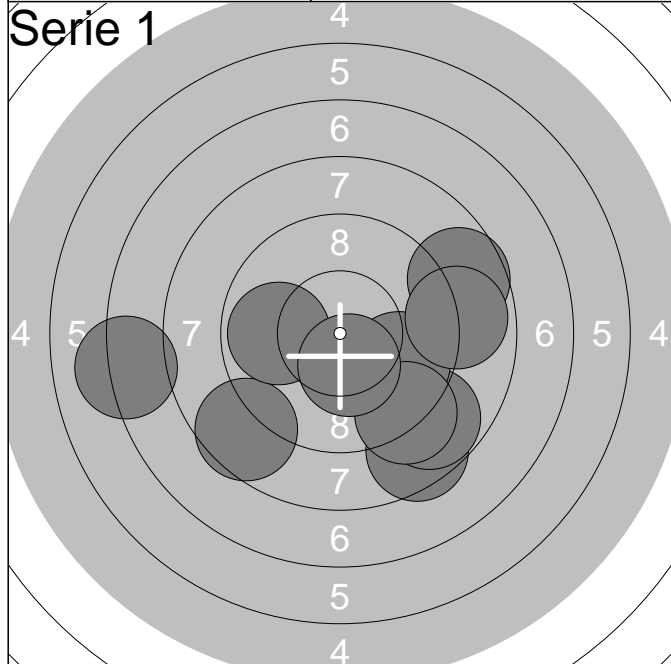

1:	8.5	↘
2:	7.1	←
3:	8.8	↘
4:	8.6	↘
5:	9.8	↘
6:	8.6	→
7:	9.1	↘
8:	8.9	→
9:	9.9	←
10:	10.4x	↘
<b>Serie</b>		<b>84.0</b>
<b>Total</b>		<b>84.0</b>

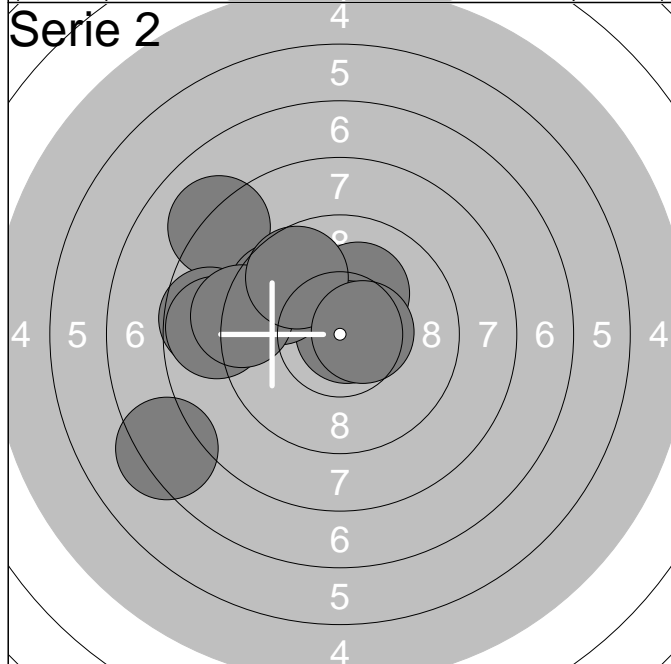

1:	10.1	↗
2:	8.1	↗
3:	8.6	←
4:	8.8	←
5:	10.8x	→
6:	9.6	↗
7:	9.2	←
8:	7.3	↘
9:	9.7	↗
10:	10.5x	→
<b>Serie</b>		<b>88.0</b>
<b>Total</b>		<b>172.0</b>

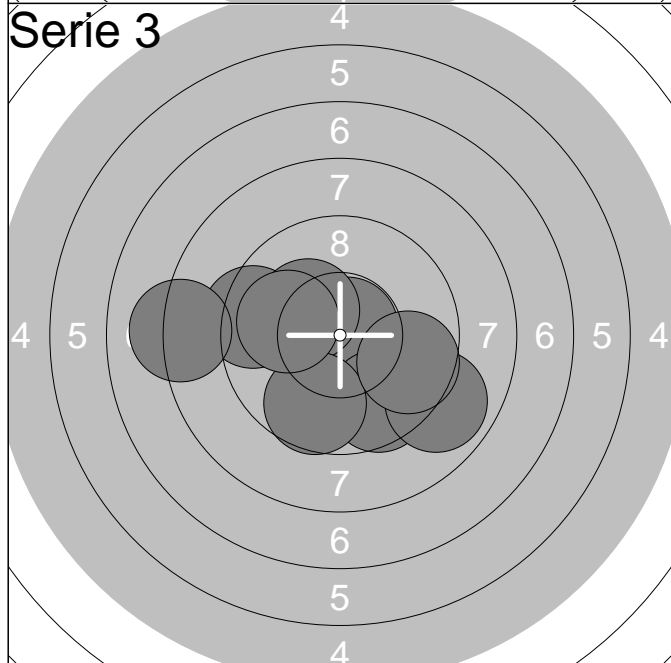

1:	10.2x	↘
2:	9.4	←
3:	10.8x	↗
4:	9.6	↘
5:	10.2x	↗
6:	9.7	↘
7:	8.9	↘
8:	10.0	←
9:	8.1	←
10:	9.6	↘
<b>Serie</b>		<b>92.0</b>
<b>Total</b>		<b>264.0</b>

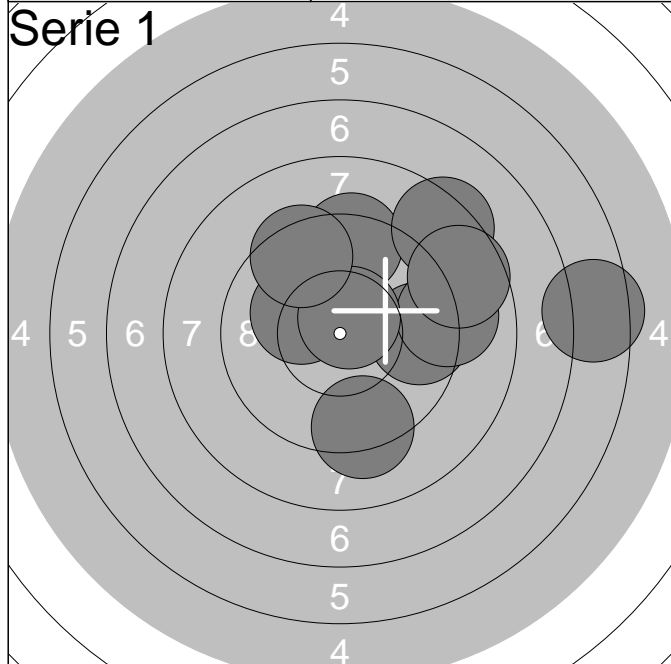

1:	10.1	↖
2:	9.2	↓
3:	6.5	→
4:	9.3	↑
5:	9.5	→
6:	9.0	→
7:	10.6x	↗
8:	8.3	↗
9:	9.4	↖
10:	8.6	↗
<b>Serie</b>		<b>87.0</b>
<b>Total</b>		<b>87.0</b>

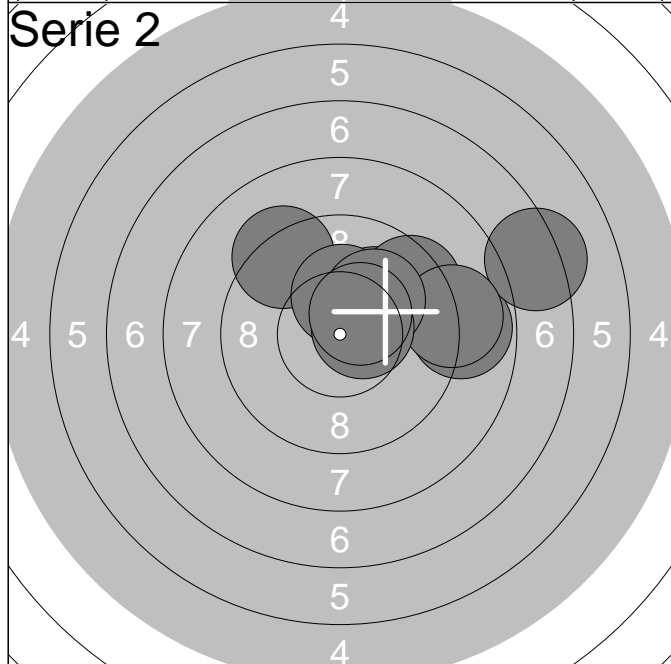

1:	9.2	↖
2:	10.0	↗
3:	8.8	→
4:	9.4	↗
5:	10.2x	↑
6:	7.3	→
7:	8.9	→
8:	10.1	↗
9:	10.5x	→
10:	10.4x	↗
<b>Serie</b>		<b>91.0</b>
<b>Total</b>		<b>178.0</b>

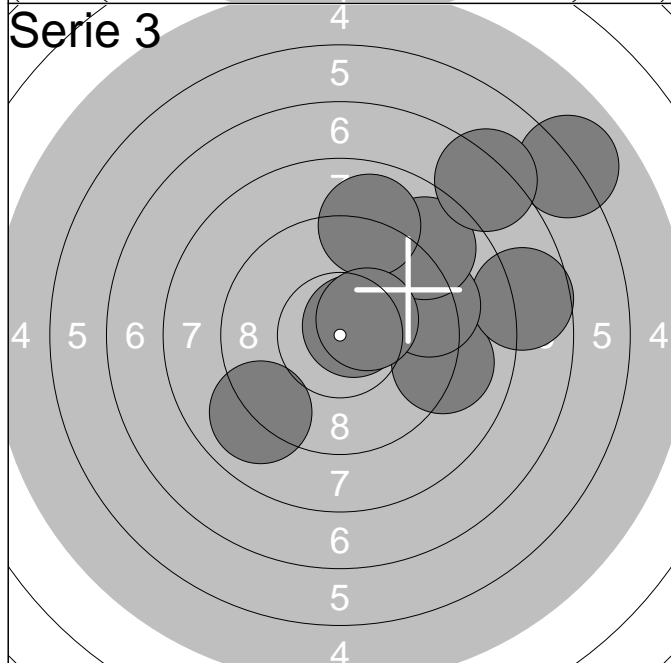

1:	10.6x	↗
2:	9.0	↖
3:	9.0	→
4:	5.9	↗
5:	7.7	→
6:	9.3	→
7:	8.8	↗
8:	7.2	↗
9:	8.9	↑
10:	10.4x	↗
<b>Serie</b>		<b>82.0</b>
<b>Total</b>		<b>260.0</b>



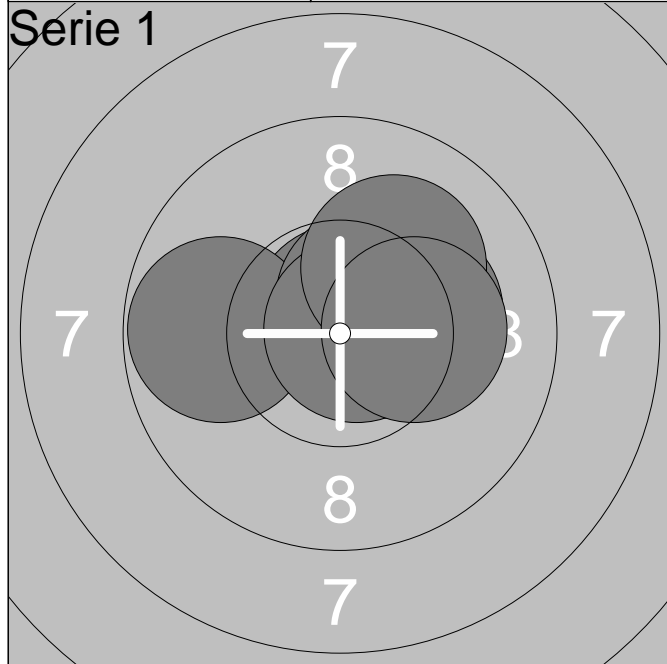

1:	10.6x	↗
2:	10.8x	↑
3:	10.2x	→
4:	9.8	←
5:	10.5x	↗
6:	10.5x	→
7:	10.2x	→
8:	10.8x	→
9:	10.1	↗
10:	10.2x	→
<b>Serie</b>		<b>99.0</b>
<b>Total</b>		<b>99.0</b>

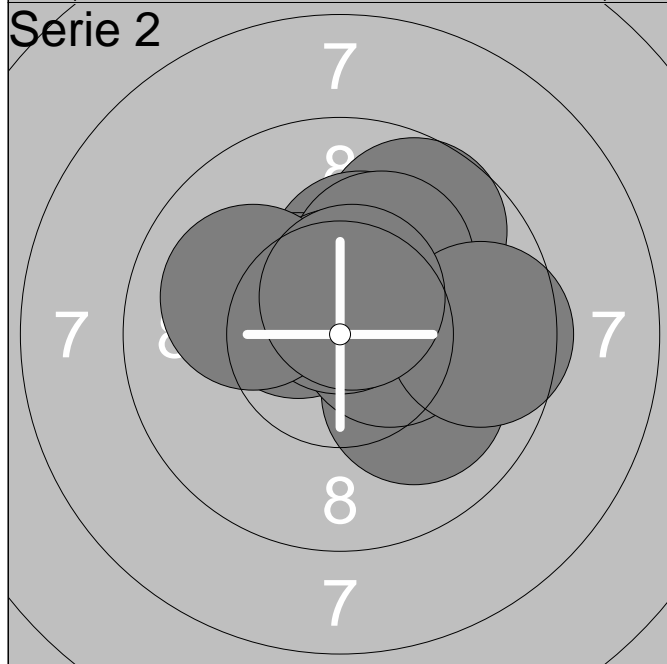

1:	9.7	↗
2:	10.0	↘
3:	10.2x	↑
4:	10.4x	↖
5:	10.4x	→
6:	10.1	↗
7:	9.6	→
8:	10.6x	↑
9:	10.0	↖
10:	10.5x	↑
<b>Serie</b>		<b>98.0</b>
<b>Total</b>		<b>197.0</b>

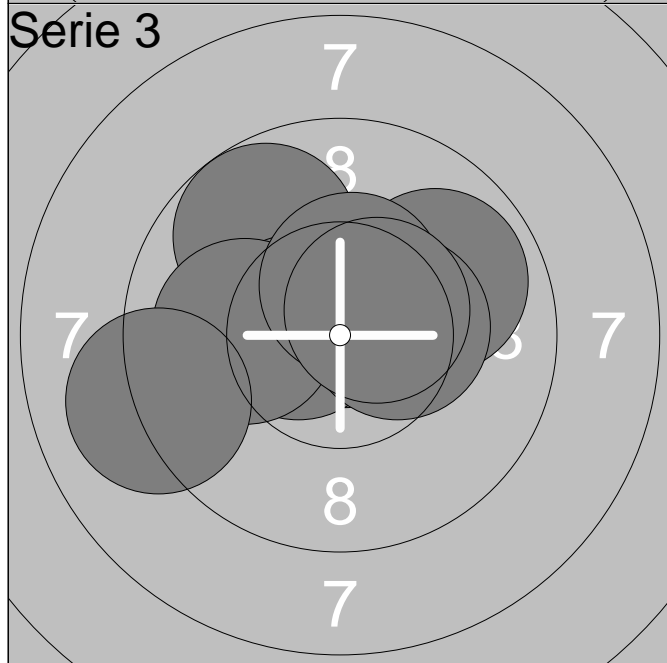

1:	10.5x	↖
2:	9.9	↗
3:	10.7x	↑
4:	9.7	↖
5:	10.5x	↖
6:	10.0	←
7:	10.4x	→
8:	10.4x	↑
9:	10.5x	↗
10:	9.0	←
<b>Serie</b>		<b>97.0</b>
<b>Total</b>		<b>294.0</b>

Lag <b>2</b>	Skive <b>14</b>	<b>Karoline Kolstad</b>	
-----------------	--------------------	-------------------------	--

Luft	Eidskog Sportsskyttere	R12	
------	------------------------	-----	--

16.04.2015	Landsstevnet rekrutt 2015	LS Rekrutt 2015	
------------	---------------------------	-----------------	--

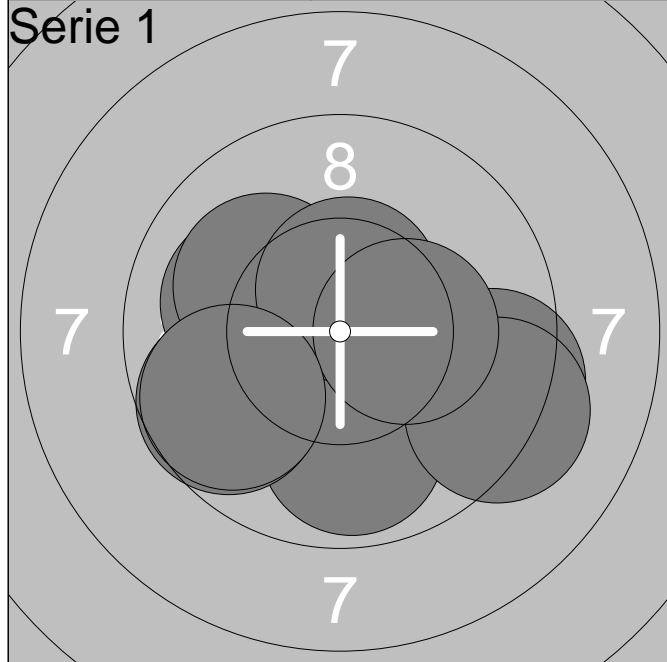

1:	10.0	↖
2:	10.8x	↗
3:	10.1	↗
4:	9.3	→
5:	9.9	↓
6:	10.5x	↑
7:	9.2	↘
8:	9.6	↖
9:	10.3x	→
10:	9.7	↙

Serie	95.0
Total	95.0

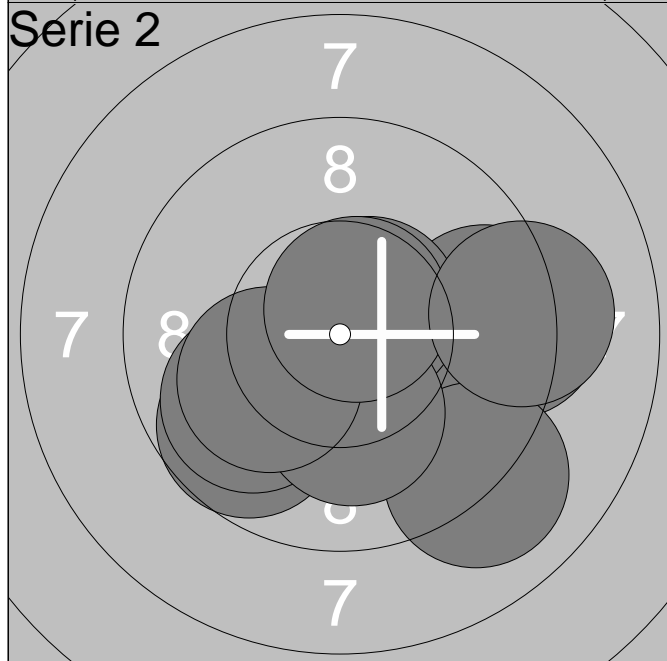

1:	9.3	→
2:	9.5	→
3:	10.6x	↗
4:	9.0	↘
5:	9.7	↙
6:	9.9	↙
7:	10.2x	↓
8:	10.1	↖
9:	10.6x	↗
10:	9.2	→

Serie	94.0
Total	189.0

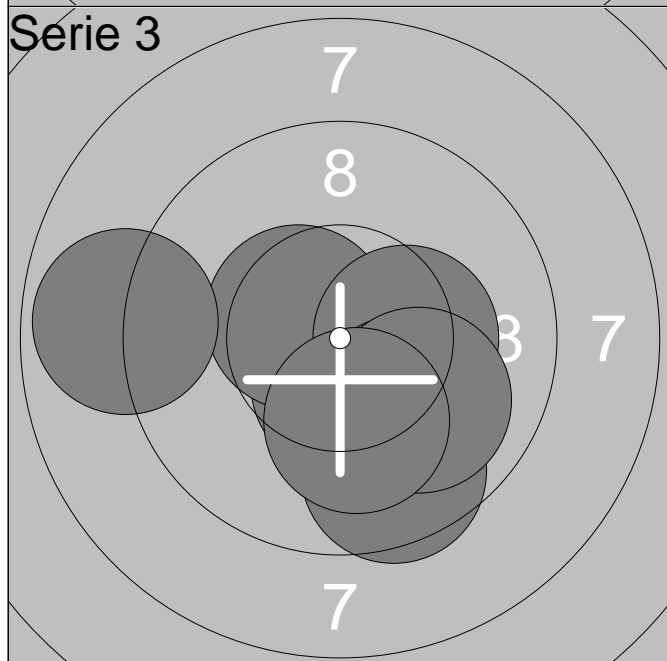

1:	10.5x	↓
2:	10.5x	↗
3:	10.1	↓
4:	8.8	←
5:	10.0	↓
6:	10.3x	→
7:	10.0	↘
8:	9.5	↘
9:	10.0	↘
10:	10.1	↓

Serie	97.0
Total	286.0

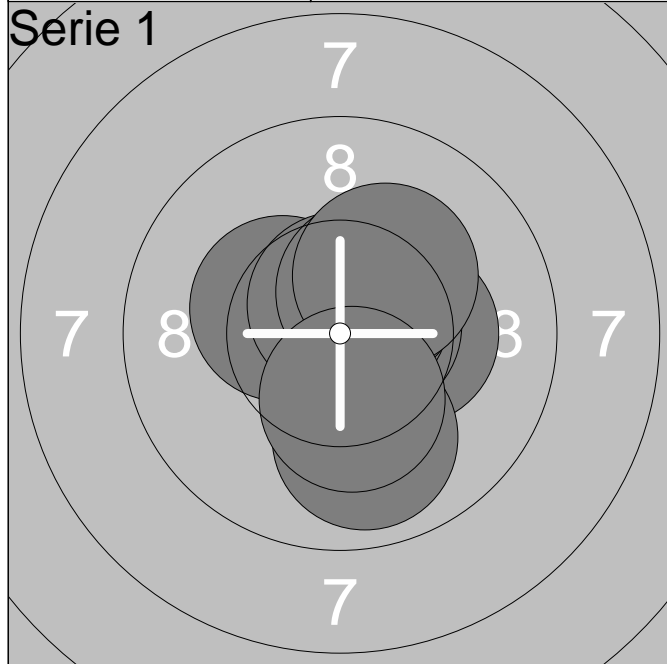

1:	10.4x	↘
2:	10.3x	→
3:	9.9	↘
4:	10.6x	→
5:	10.7x	↗
6:	10.3x	↖
7:	10.7x	↑
8:	10.4x	↗
9:	10.2x	↗
10:	10.3x	↘
<b>Serie</b>		<b>99.0</b>
<b>Total</b>		<b>99.0</b>

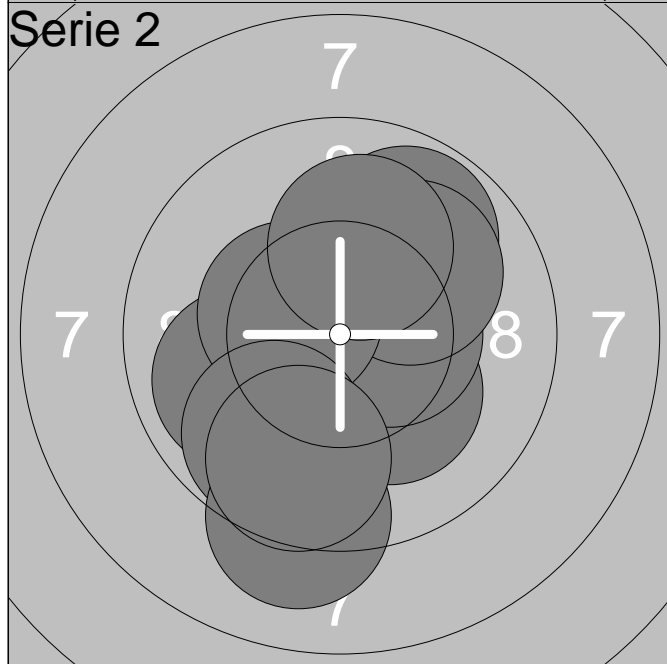

1:	9.9	↖
2:	10.2x	↘
3:	9.8	↗
4:	10.5x	→
5:	10.0	↗
6:	10.4x	↖
7:	9.8	↘
8:	10.1	↑
9:	9.1	↘
10:	9.7	↘
<b>Serie</b>		<b>95.0</b>
<b>Total</b>		<b>194.0</b>

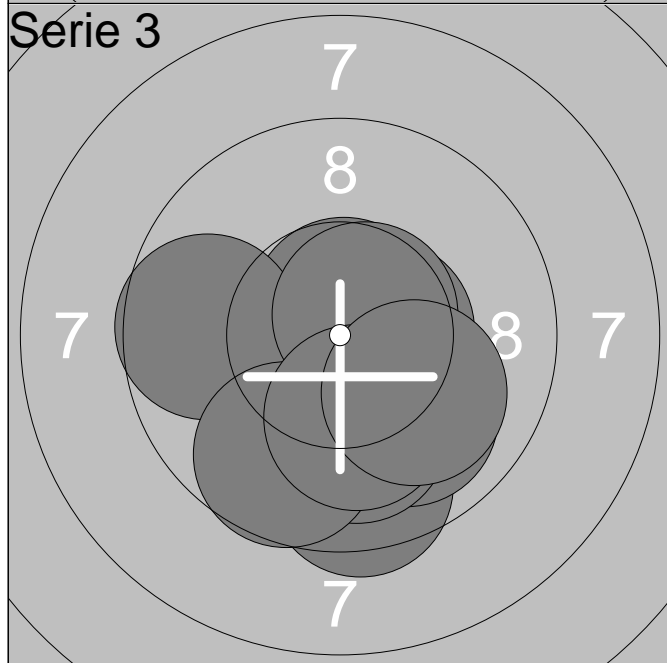

1:	9.5	↘
2:	10.5x	→
3:	10.7x	↑
4:	9.7	↖
5:	10.6x	↗
6:	9.9	↘
7:	10.0	↘
8:	9.6	↘
9:	10.1	↘
10:	10.0	↘
<b>Serie</b>		<b>96.0</b>
<b>Total</b>		<b>290.0</b>

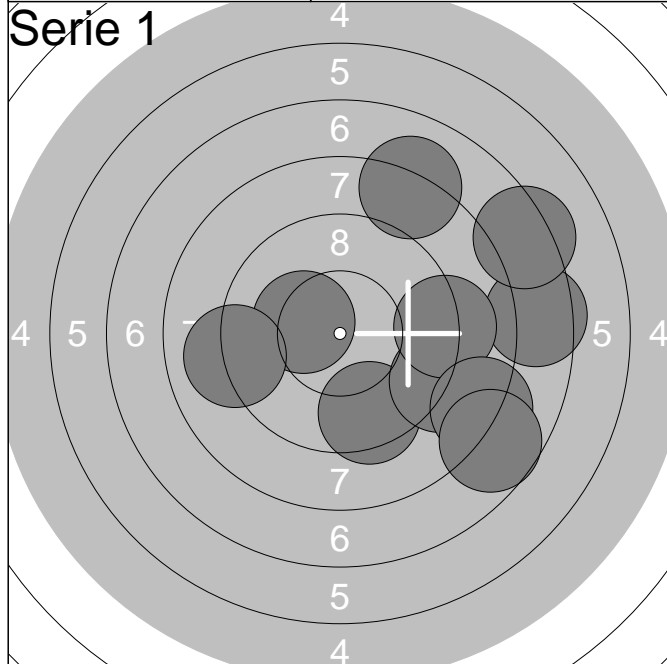

1:	7.5	→
2:	9.4	↓
3:	9.0	↘
4:	9.1	→
5:	10.3x	↖
6:	8.1	↘
7:	8.1	↗
8:	9.0	←
9:	7.7	↘
10:	7.3	↗
<b>Serie</b>		<b>83.0</b>
<b>Total</b>		<b>83.0</b>

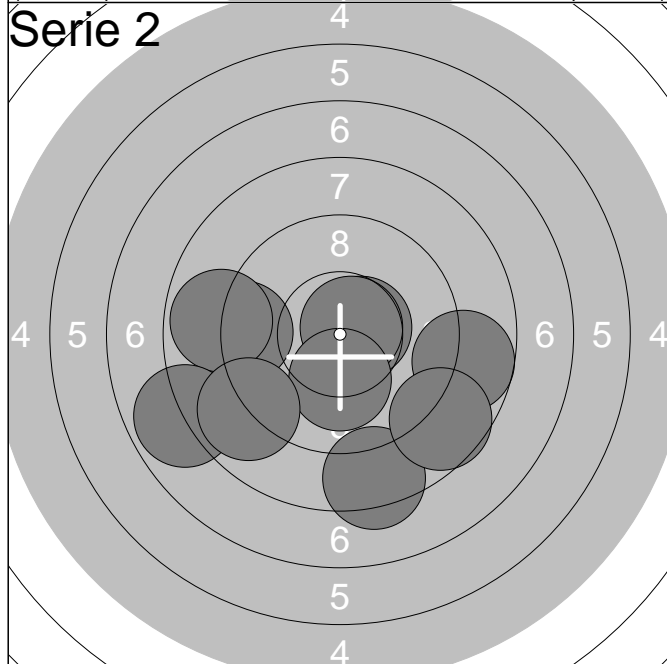

1:	8.7	→
2:	8.3	↓
3:	9.2	←
4:	8.8	←
5:	10.6x	→
6:	7.8	←
7:	8.6	↘
8:	10.7x	↗
9:	10.1	↓
10:	8.9	↙
<b>Serie</b>		<b>86.0</b>
<b>Total</b>		<b>169.0</b>

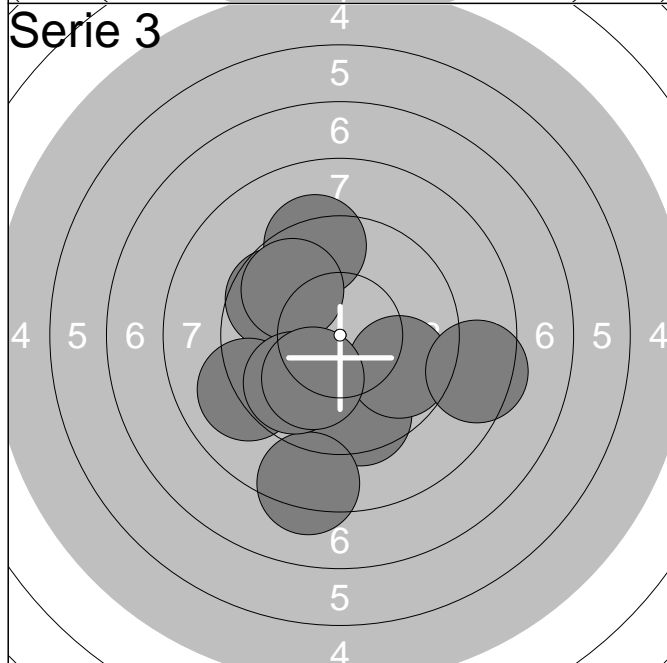

1:	9.5	↓
2:	9.3	↗
3:	9.6	↗
4:	8.3	↓
5:	9.7	↘
6:	9.8	↗
7:	9.0	←
8:	9.8	↙
9:	8.4	→
10:	10.0	↙
<b>Serie</b>		<b>89.0</b>
<b>Total</b>		<b>258.0</b>

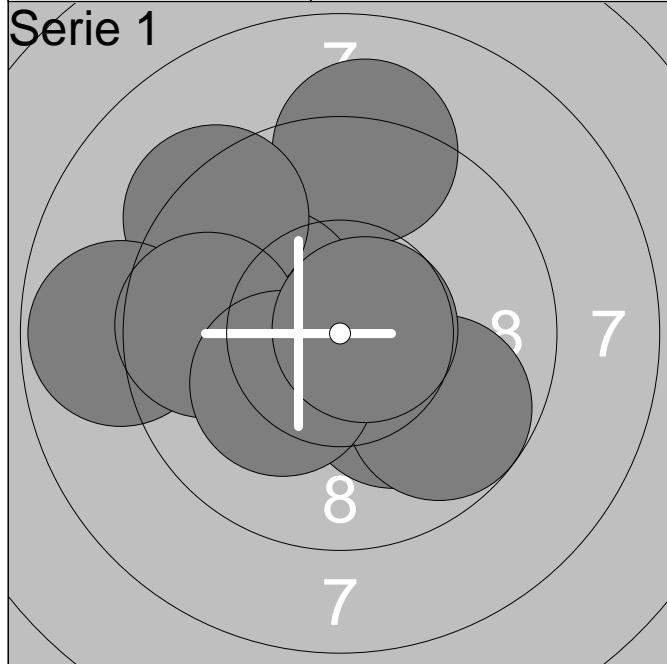

1:	10.2x	↘
2:	9.2	↑
3:	10.1	↗
4:	9.7	↘
5:	10.2x	↗
6:	9.3	↗
7:	8.8	←
8:	9.6	←
9:	10.2x	↙
10:	10.7x	→

Serie	<b>94.0</b>
Total	<b>94.0</b>

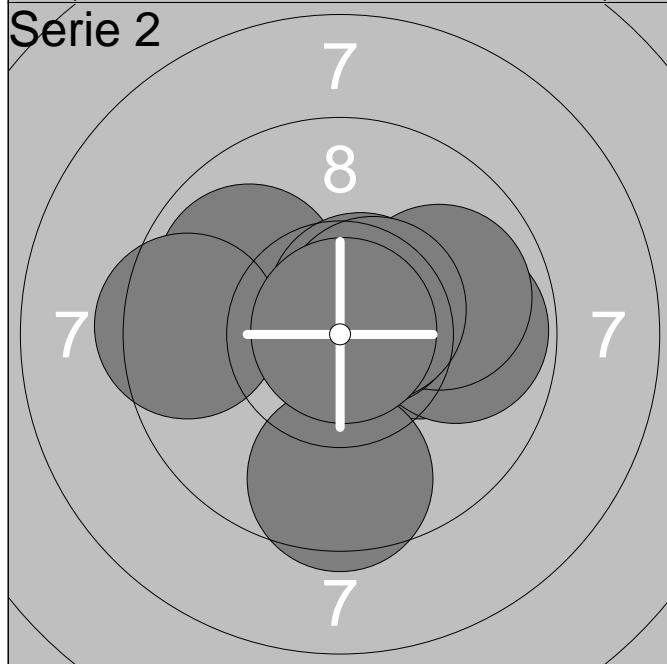

1:	10.2x	→
2:	9.5	↓
3:	9.8	→
4:	9.9	↖
5:	10.6x	↗
6:	9.5	←
7:	9.9	→
8:	10.6x	↗
9:	10.5x	↗
10:	10.9x	↗

Serie	<b>95.0</b>
Total	<b>189.0</b>

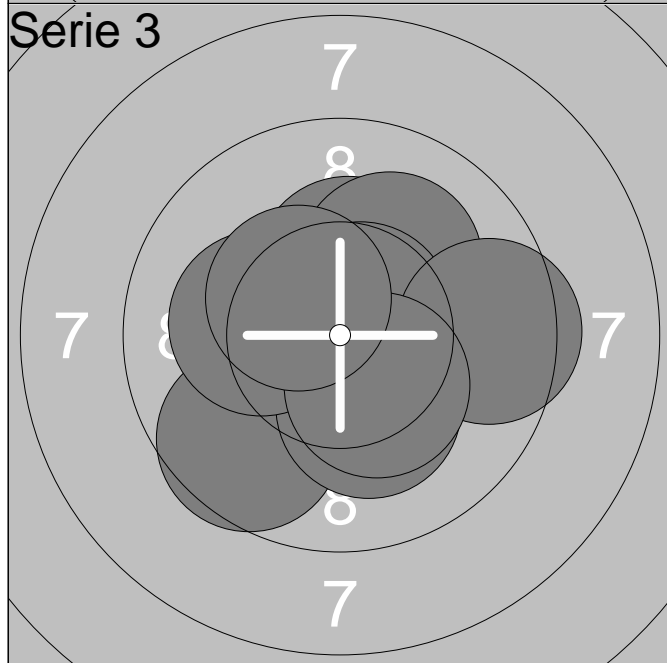

1:	9.6	↙
2:	10.3x	↑
3:	10.7x	↗
4:	10.2x	↘
5:	10.1	↗
6:	10.6x	↗
7:	10.2x	←
8:	9.5	→
9:	10.3x	↘
10:	10.4x	↗

Serie	<b>98.0</b>
Total	<b>287.0</b>

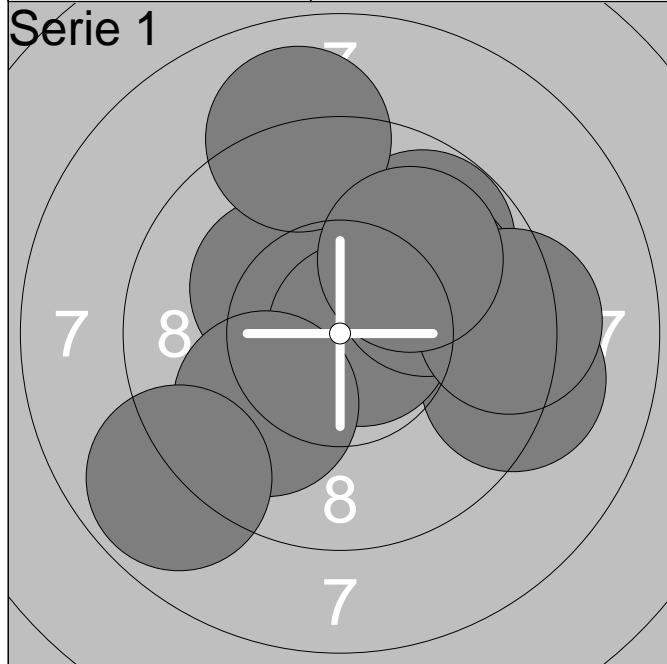

1:	10.2x	↗
2:	9.7	↗
3:	9.2	→
4:	10.7x	→
5:	10.0	↗
6:	9.9	↙
7:	9.0	↑
8:	8.8	↙
9:	9.3	→
10:	9.9	↗

Serie	92.0
Total	92.0

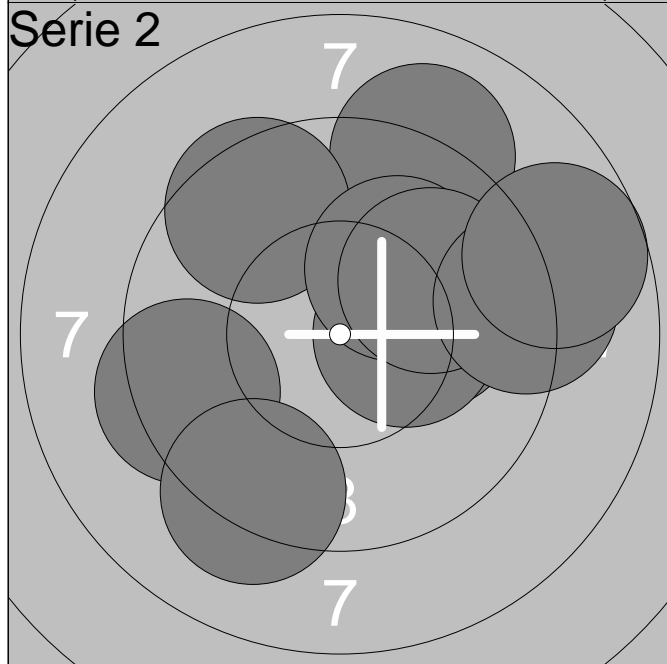

1:	9.3	←
2:	10.1	→
3:	9.0	↗
4:	9.5	↗
5:	10.3x	→
6:	10.1	↗
7:	9.9	↗
8:	9.1	→
9:	8.7	→
10:	9.2	↙

Serie	92.0
Total	184.0

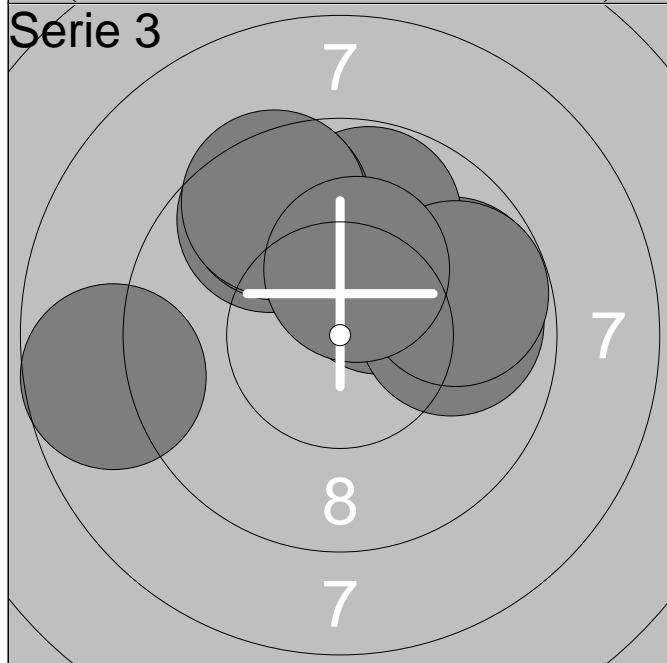

1:	9.8	→
2:	8.7	←
3:	10.3x	↗
4:	9.6	↗
5:	9.8	↑
6:	9.8	→
7:	9.5	↗
8:	9.5	↗
9:	9.7	→
10:	10.3x	↑

Serie	91.0
Total	275.0

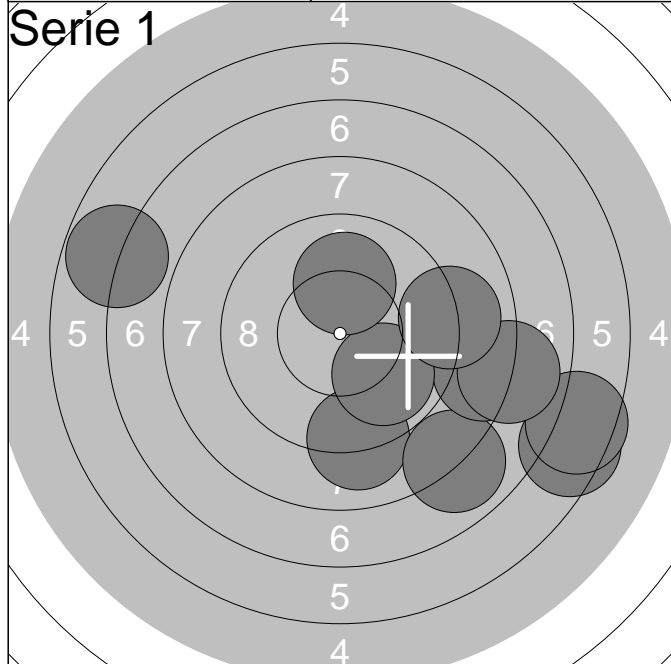

1:	6.4	→
2:	9.1	↓
3:	7.9	↓
4:	6.5	→
5:	6.8	↖
6:	8.4	→
7:	9.9	↓
8:	7.9	→
9:	10.0	↑
10:	9.0	→
<b>Serie</b>		<b>77.0</b>
<b>Total</b>		<b>77.0</b>

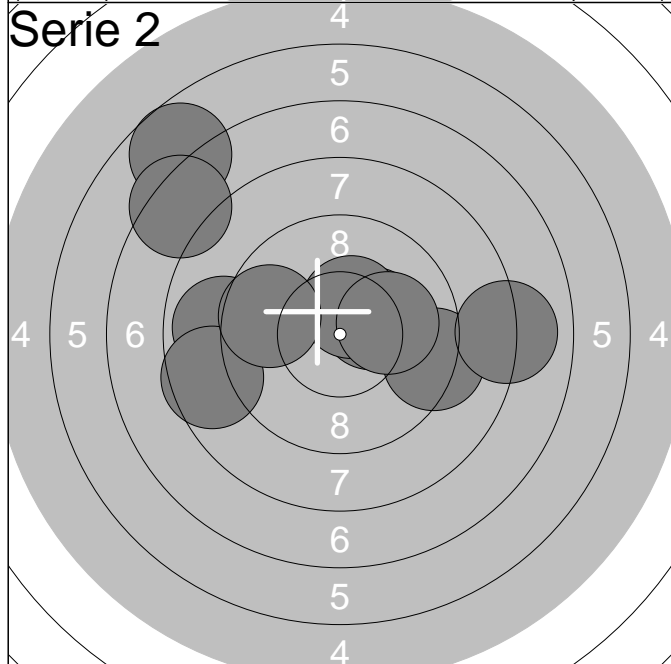

1:	10.3x	↗
2:	8.9	←
3:	9.2	→
4:	10.4x	↑
5:	8.0	→
6:	8.6	←
7:	9.7	↖
8:	6.7	↗
9:	10.1	→
10:	7.3	↖
<b>Serie</b>		<b>85.0</b>
<b>Total</b>		<b>162.0</b>



1:	10.2x	↓
2:	6.5	→
3:	6.0	←
4:	9.9	→
5:	10.5x	↓
6:	9.3	↗
7:	8.9	↖
8:	10.4x	↗
9:	9.2	↑
10:	10.6x	→
<b>Serie</b>		<b>87.0</b>
<b>Total</b>		<b>249.0</b>

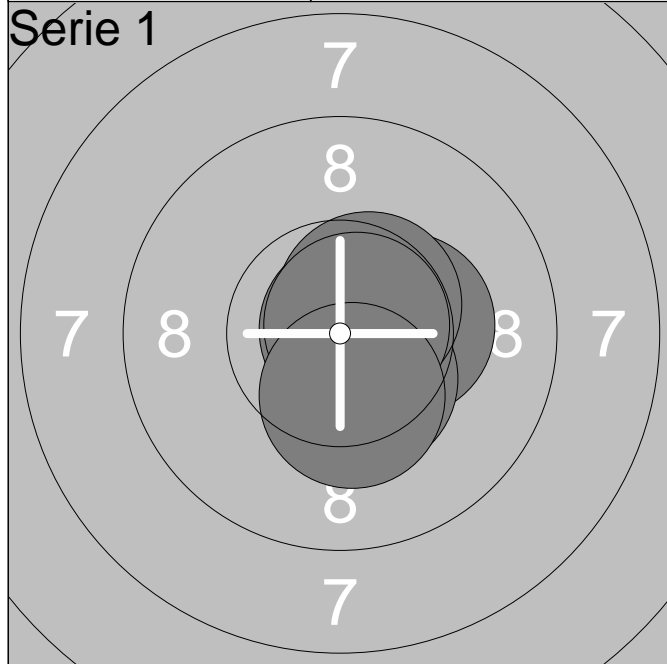

1:	10.5x	↓
2:	10.6x	↗
3:	10.6x	→
4:	10.4x	↓
5:	10.3x	→
6:	10.8x	→
7:	10.4x	↓
8:	10.5x	↗
9:	10.8x	↗
10:	10.3x	↓
<b>Serie</b>		<b>100.0</b>
<b>Total</b>		<b>100.0</b>

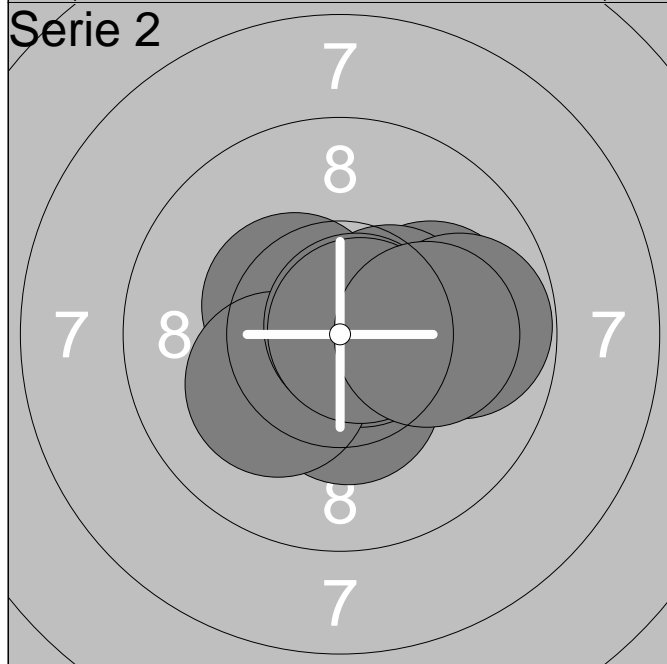

1:	10.4x	↓
2:	10.7x	→
3:	10.0	→
4:	10.4x	→
5:	10.4x	↖
6:	10.2x	↙
7:	9.8	→
8:	10.8x	↗
9:	10.7x	→
10:	10.1	→
<b>Serie</b>		<b>99.0</b>
<b>Total</b>		<b>199.0</b>

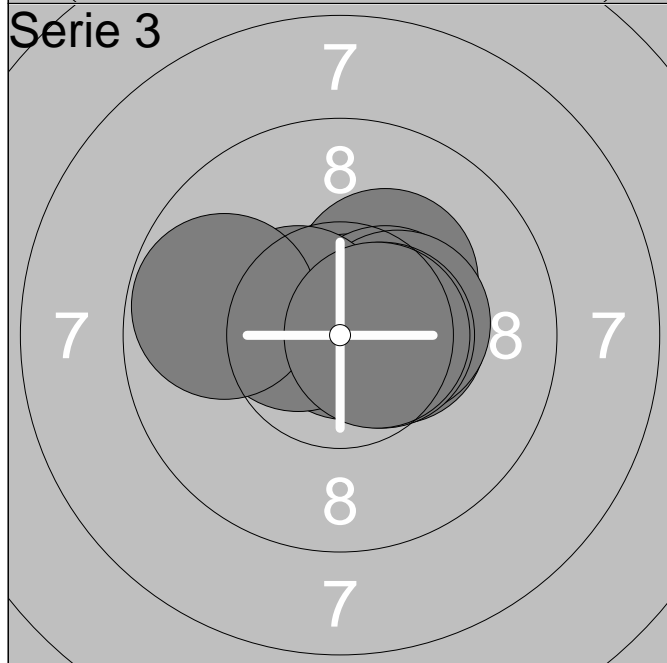

1:	10.5x	↗
2:	10.2x	↗
3:	10.8x	↗
4:	10.4x	→
5:	10.5x	↗
6:	10.4x	→
7:	10.5x	↖
8:	10.5x	→
9:	9.8	↖
10:	10.6x	→
<b>Serie</b>		<b>99.0</b>
<b>Total</b>		<b>298.0</b>



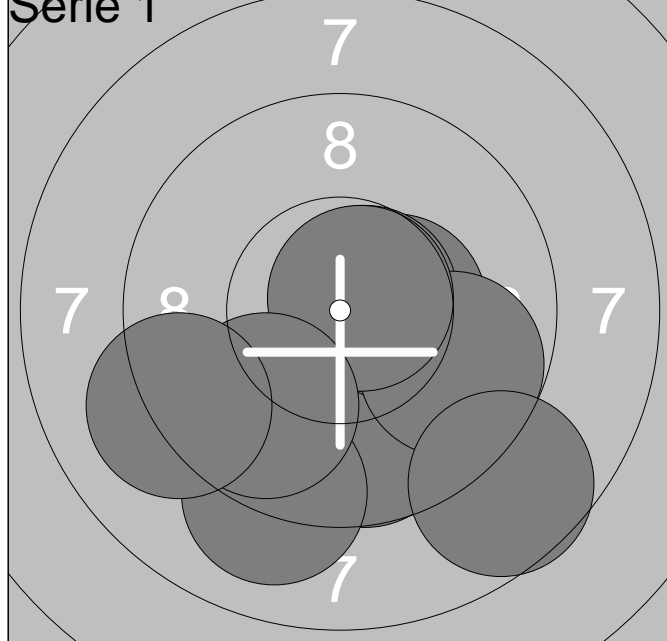

1:	9.7	↓
2:	10.4x	→
3:	10.6x	↗
4:	9.7	↘
5:	10.7x	↗
6:	9.7	↘
7:	8.6	↓
8:	9.0	↓
9:	9.8	↘
10:	9.1	↙
<b>Serie</b>		<b>92.0</b>
<b>Total</b>		<b>92.0</b>



1:	10.1	↙
2:	10.2x	↙
3:	10.2x	↙
4:	10.2x	↘
5:	10.7x	↗
6:	10.9x	→
7:	9.5	↗
8:	10.6x	↗
9:	8.2	→
10:	10.2x	→
<b>Serie</b>		<b>97.0</b>
<b>Total</b>		<b>189.0</b>

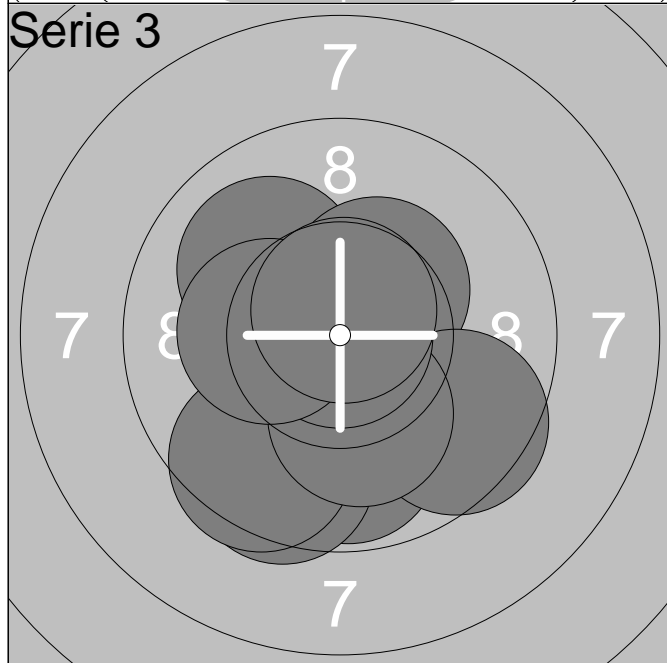

1:	9.8	↓
2:	9.5	↘
3:	10.0	↙
4:	9.5	↘
5:	10.3x	↗
6:	9.5	↘
7:	10.1	↓
8:	10.9x	↓
9:	10.2x	↙
10:	10.7x	↗
<b>Serie</b>		<b>96.0</b>
<b>Total</b>		<b>285.0</b>

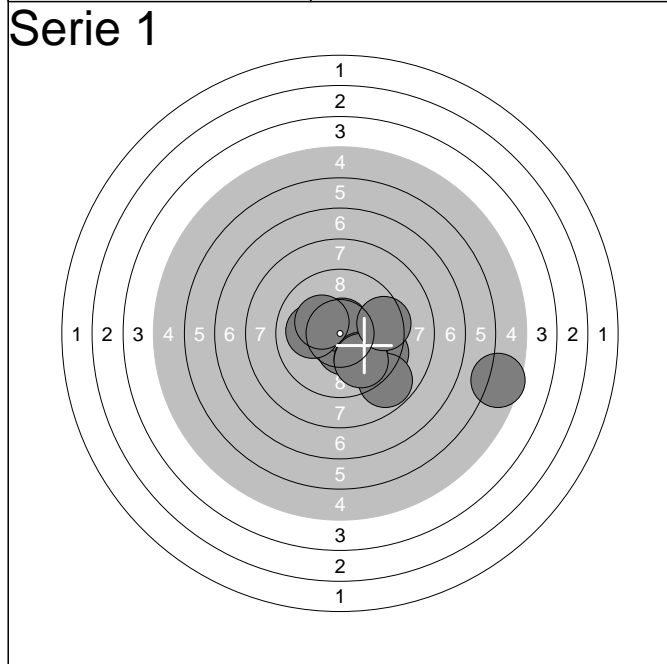

1:	10.4x	↓
2:	10.6x	↑
3:	9.4	↘
4:	9.8	↓
5:	8.8	↘
6:	5.5	→
7:	10.1	←
8:	10.2x	↗
9:	9.8	↘
10:	9.5	→
<b>Serie</b>		<b>89.0</b>
<b>Total</b>		<b>89.0</b>

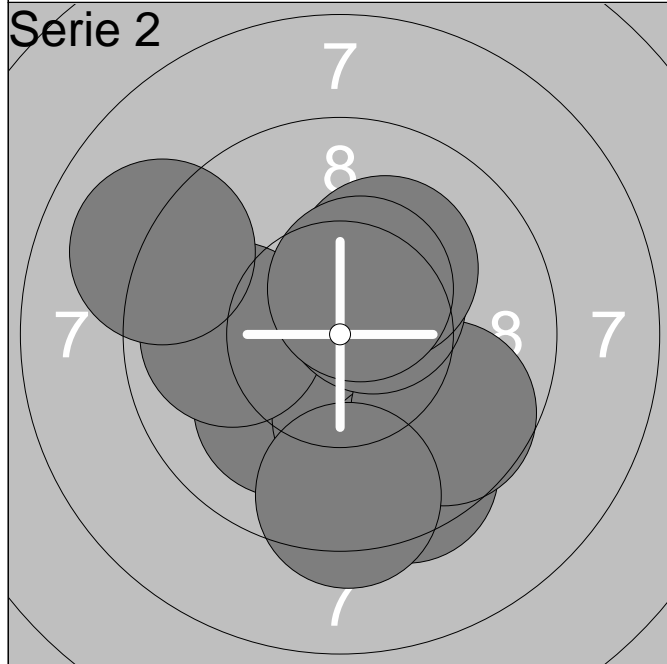

1:	10.1	↙
2:	10.1	↓
3:	9.5	↘
4:	9.7	↘
5:	9.9	←
6:	10.5x	↗
7:	10.1	↗
8:	10.4x	↗
9:	9.4	↓
10:	9.1	↙
<b>Serie</b>		<b>95.0</b>
<b>Total</b>		<b>184.0</b>

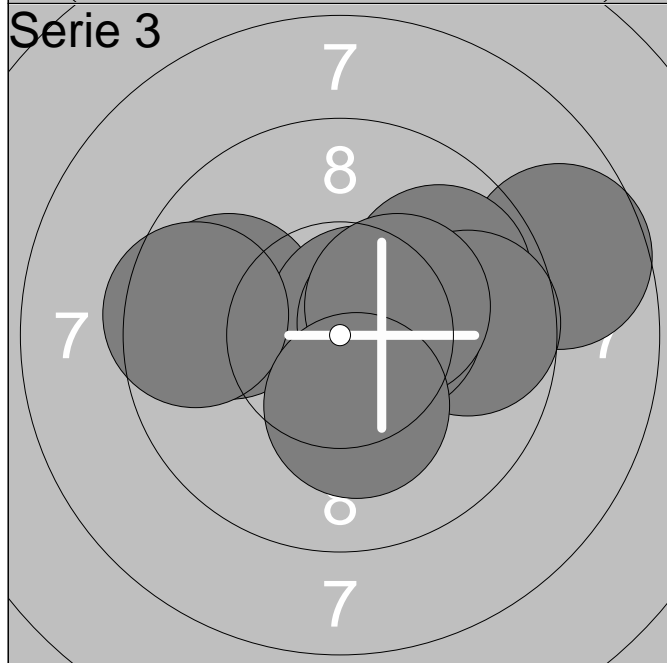

1:	8.7	→
2:	9.8	←
3:	10.1	→
4:	9.8	↗
5:	10.7x	↗
6:	9.5	←
7:	9.7	→
8:	10.4x	→
9:	10.3x	↗
10:	10.2x	↓
<b>Serie</b>		<b>94.0</b>
<b>Total</b>		<b>278.0</b>

Lag	Skive	Nicolai Grindal		
3	5	Krapfoss Sportskytterlag	R13	
16.04.2015	Landsstevnet rekrutt 2015	LS Rekrutt 2015		
<b>Serie 1</b> 	1:	10.3x	↘	
	2:	10.4x	←	
	3:	10.1	↗	
	4:	10.6x	↑	
	5:	10.0	↘	
	6:	9.5	←	
	7:	9.4	↗	
	8:	10.4x	↑	
	9:	9.6	↙	
	10:	10.7x	↗	
	<b>Serie</b>			<b>97.0</b>
<b>Total</b>			<b>97.0</b>	
<b>Serie 2</b> 	1:	10.0	↗	
	2:	10.4x	↘	
	3:	9.8	→	
	4:	10.6x	→	
	5:	10.3x	→	
	6:	9.6	↙	
	7:	10.1	↗	
	8:	9.8	↓	
	9:	10.2x	↓	
	10:	10.1	↙	
	<b>Serie</b>			<b>97.0</b>
<b>Total</b>			<b>194.0</b>	
<b>Serie 3</b> 	1:	9.9	↗	
	2:	10.4x	→	
	3:	10.5x	↑	
	4:	9.6	↙	
	5:	10.3x	←	
	6:	10.4x	→	
	7:	10.8x	→	
	8:	9.7	↓	
	9:	10.3x	↗	
	10:	10.7x	→	
	<b>Serie</b>			<b>97.0</b>
<b>Total</b>			<b>291.0</b>	

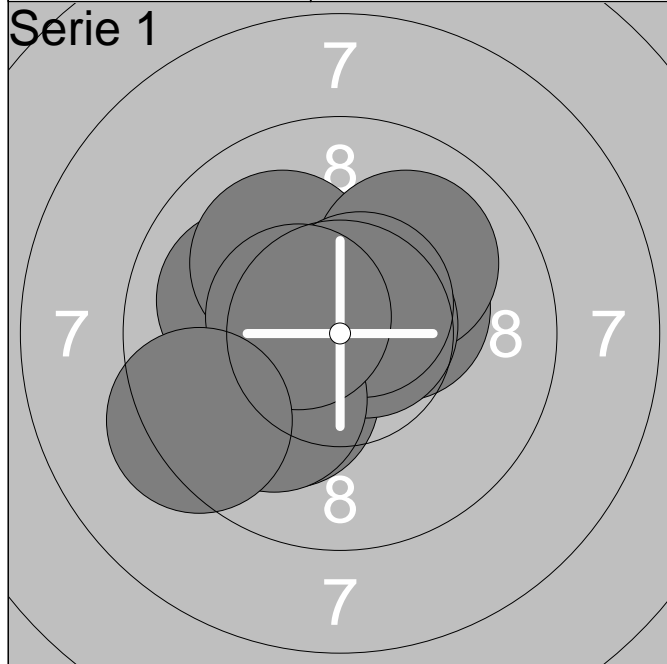

1:	10.3x	→
2:	10.0	←
3:	10.0	↖
4:	10.1	↙
5:	10.0	↗
6:	10.7x	→
7:	10.6x	↗
8:	10.0	↙
9:	10.5x	←
10:	9.3	↙
<b>Serie</b>		<b>99.0</b>
<b>Total</b>		<b>99.0</b>

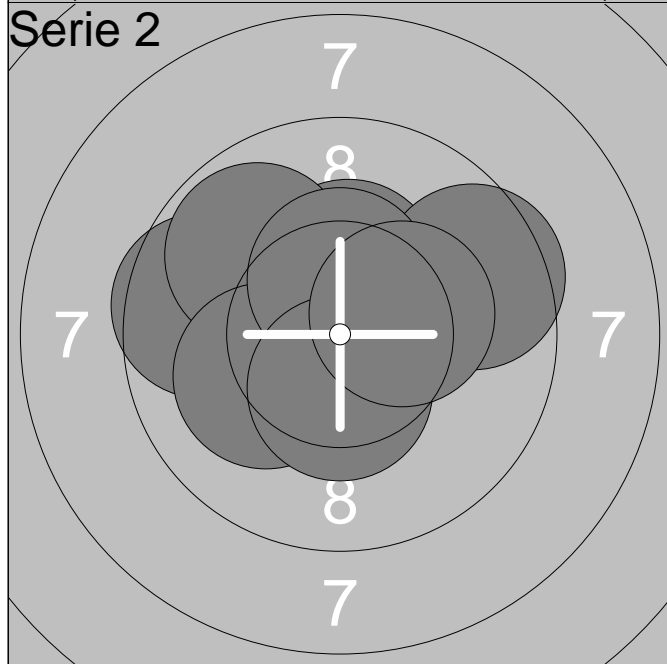

1:	10.3x	↑
2:	10.7x	↗
3:	9.6	←
4:	10.6x	↑
5:	9.8	↖
6:	9.5	→
7:	10.1	↙
8:	10.4x	↑
9:	10.4x	↓
10:	10.3x	→
<b>Serie</b>		<b>97.0</b>
<b>Total</b>		<b>196.0</b>

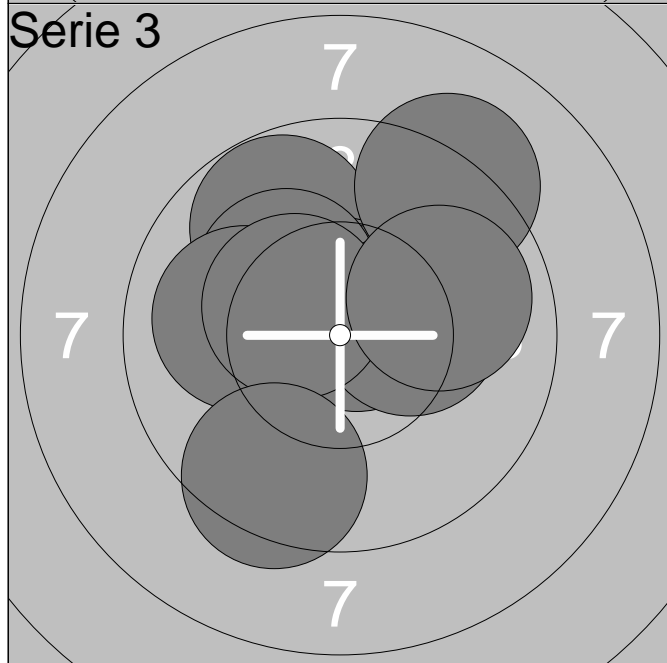

1:	9.7	↖
2:	10.7x	↑
3:	10.7x	↗
4:	10.2x	↖
5:	10.0	←
6:	10.2x	→
7:	9.1	↗
8:	10.4x	↖
9:	9.4	↙
10:	9.9	→
<b>Serie</b>		<b>96.0</b>
<b>Total</b>		<b>292.0</b>

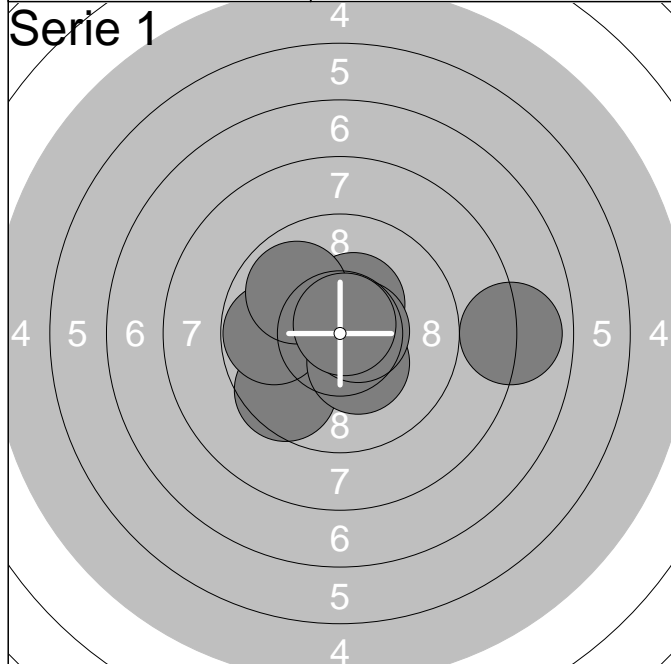

1:	10.8x	↗
2:	9.5	↙
3:	10.7x	↑
4:	10.4x	↗
5:	9.8	←
6:	10.3x	↘
7:	7.9	→
8:	9.9	↗
9:	10.6x	→
10:	10.7x	↗
<b>Serie</b>		<b>94.0</b>
<b>Total</b>		<b>94.0</b>

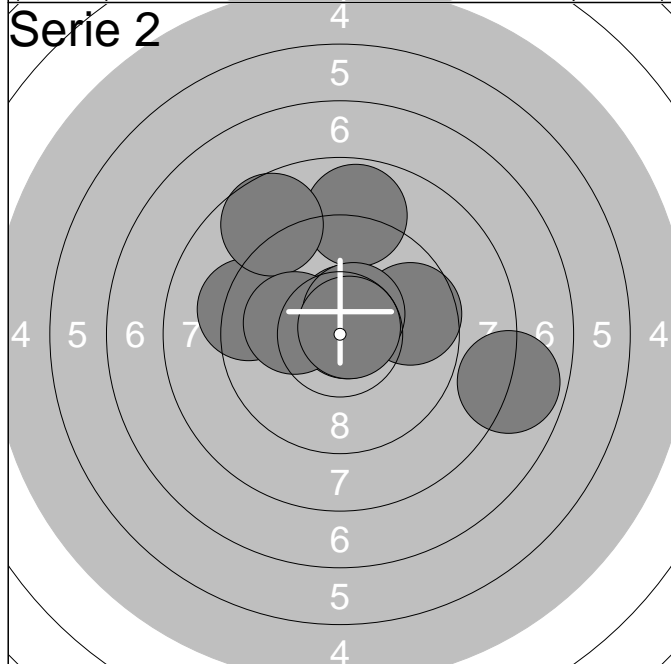

1:	8.8	↑
2:	10.7x	↗
3:	9.3	←
4:	8.7	↗
5:	10.6x	↑
6:	10.1	←
7:	7.8	→
8:	9.6	→
9:	10.5x	↗
10:	10.7x	↗
<b>Serie</b>		<b>91.0</b>
<b>Total</b>		<b>185.0</b>

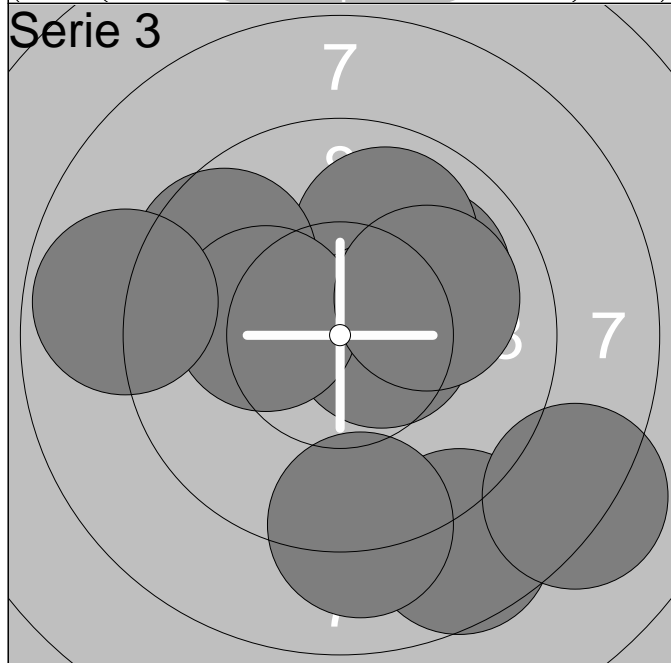

1:	10.0	↗
2:	9.9	↗
3:	8.6	↘
4:	9.6	↗
5:	8.2	↘
6:	10.5x	→
7:	10.2x	←
8:	9.1	↘
9:	10.0	↗
10:	8.8	←
<b>Serie</b>		<b>91.0</b>
<b>Total</b>		<b>276.0</b>

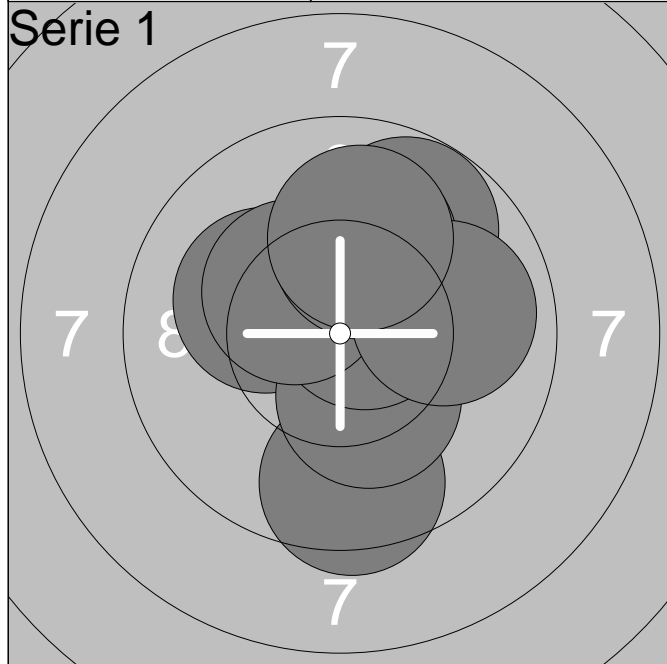

1:	10.2x	↖
2:	10.3x	↗
3:	9.5	↓
4:	10.3x	↓
5:	9.7	↗
6:	10.7x	↗
7:	10.3x	↖
8:	10.1	↗
9:	9.9	→
10:	10.0	↗
<b>Serie</b>		<b>97.0</b>
<b>Total</b>		<b>97.0</b>



1:	10.1	↖
2:	10.5x	↗
3:	10.6x	↗
4:	10.6x	↑
5:	10.8x	↗
6:	10.3x	←
7:	10.2x	↓
8:	10.5x	←
9:	9.9	→
10:	10.2x	↙
<b>Serie</b>		<b>99.0</b>
<b>Total</b>		<b>196.0</b>

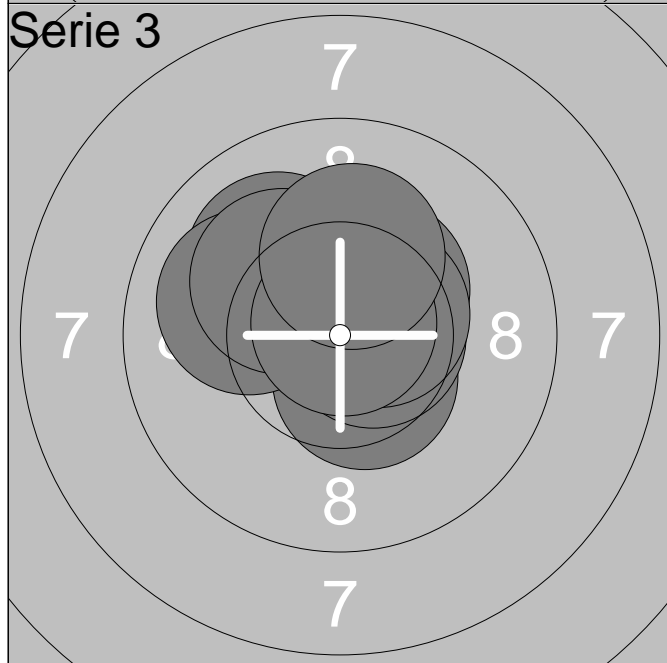

1:	10.4x	↓
2:	10.0	↗
3:	10.6x	→
4:	10.7x	↗
5:	10.3x	↗
6:	10.0	←
7:	10.5x	↗
8:	10.1	↖
9:	10.8x	↗
10:	10.1	↗
<b>Serie</b>		<b>100.0</b>
<b>Total</b>		<b>296.0</b>

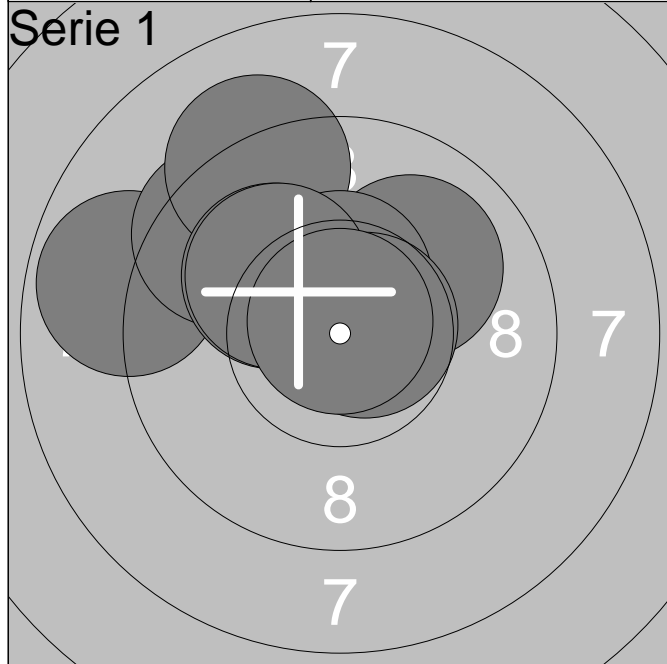

1:	9.6	↗
2:	8.8	↖
3:	9.4	↗
4:	10.0	↗
5:	9.1	↗
6:	10.4x	↑
7:	10.7x	→
8:	10.1	↗
9:	10.1	↗
10:	10.8x	↑
<b>Serie</b>		<b>95.0</b>
<b>Total</b>		<b>95.0</b>

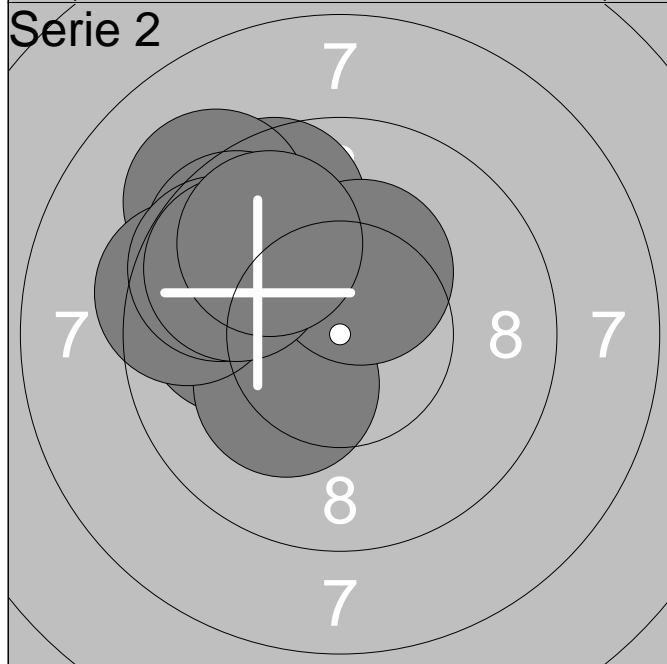

1:	9.9	↖
2:	10.2x	↙
3:	9.5	↗
4:	9.2	↗
5:	9.6	↗
6:	9.4	↖
7:	10.3x	↗
8:	9.6	↗
9:	9.7	↗
10:	9.8	↗
<b>Serie</b>		<b>92.0</b>
<b>Total</b>		<b>187.0</b>



1:	10.2x	↖
2:	9.6	↑
3:	8.1	↖
4:	10.4x	↗
5:	9.6	↗
6:	8.9	↗
7:	8.8	↗
8:	10.0	↗
9:	9.4	↗
10:	9.6	↑
<b>Serie</b>		<b>90.0</b>
<b>Total</b>		<b>277.0</b>

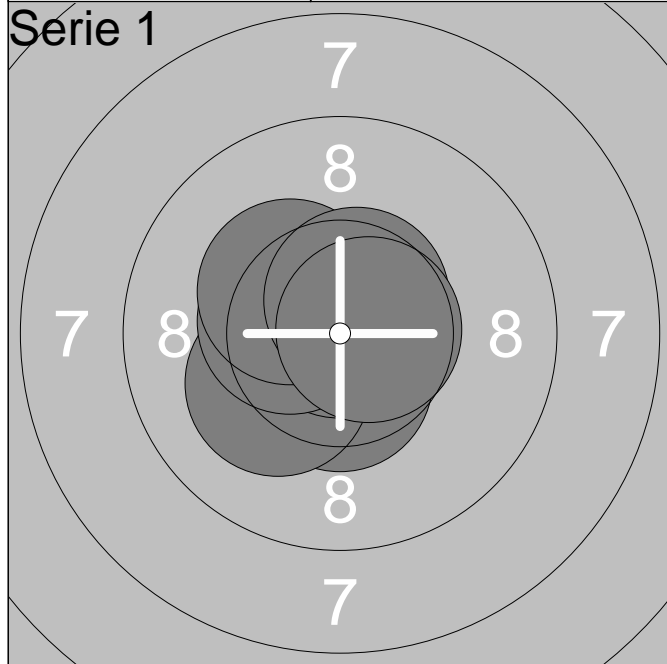

1:	10.7x	↑
2:	10.3x	↙
3:	10.5x	←
4:	10.5x	↓
5:	10.2x	↙
6:	10.8x	↑
7:	10.4x	←
8:	10.3x	↗
9:	10.6x	↑
10:	10.7x	→
<b>Serie</b>		<b>100.0</b>
<b>Total</b>		<b>100.0</b>

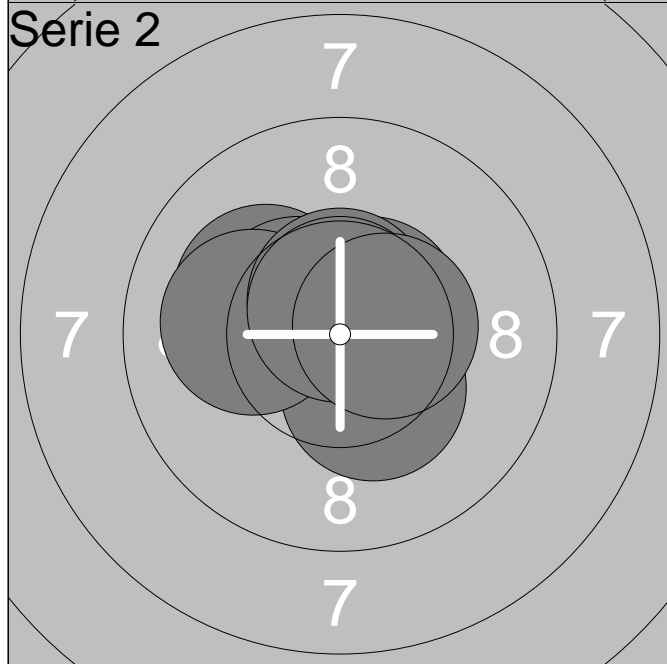

1:	10.8x	↗
2:	10.6x	↗
3:	10.1	↖
4:	10.4x	↖
5:	10.3x	↓
6:	10.1	←
7:	10.5x	↗
8:	10.6x	↑
9:	10.7x	↑
10:	10.5x	→
<b>Serie</b>		<b>100.0</b>
<b>Total</b>		<b>200.0</b>





1:	10.6x	↑
2:	10.4x	↗
3:	10.2x	↓
4:	10.6x	↑
5:	10.0	↖
6:	10.8x	→
7:	10.3x	↑
8:	10.7x	→
9:	10.6x	↗
10:	10.8x	↗
<b>Serie</b>		<b>100.0</b>
<b>Total</b>		<b>300.0</b>

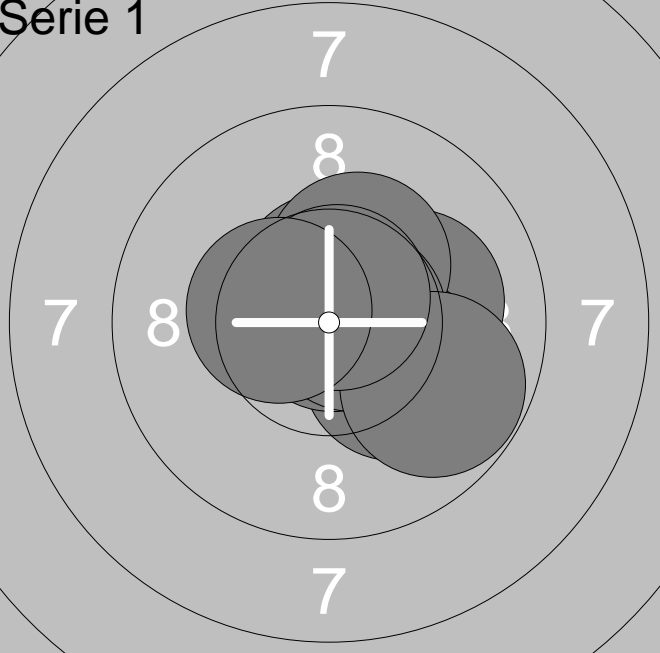
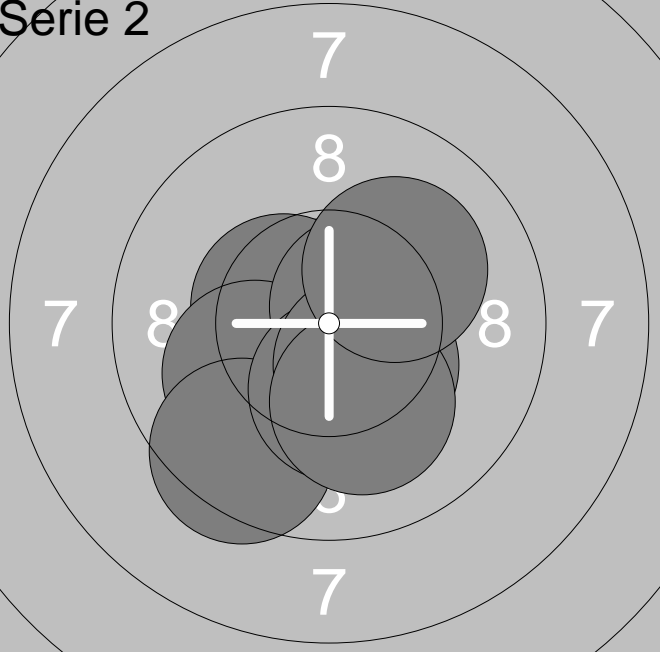

16.04.2015	Landsstevnet rekrutt 2015	LS Rekrutt 2015
------------	---------------------------	-----------------

<p><b>Serie 1</b></p> 	<table style="width:100%; border-collapse: collapse;"> <tr><td style="width:5%;">1:</td><td style="width:15%;">10.1</td><td style="width:10%; text-align: right;">→</td></tr> <tr><td>2:</td><td>10.6x</td><td style="text-align: right;">↑</td></tr> <tr><td>3:</td><td>10.2x</td><td style="text-align: right;">↘</td></tr> <tr><td>4:</td><td>10.7x</td><td style="text-align: right;">↗</td></tr> <tr><td>5:</td><td>10.9x</td><td style="text-align: right;">↗</td></tr> <tr><td>6:</td><td>10.3x</td><td style="text-align: right;">↑</td></tr> <tr><td>7:</td><td>10.7x</td><td style="text-align: right;">→</td></tr> <tr><td>8:</td><td>9.8</td><td style="text-align: right;">↘</td></tr> <tr><td>9:</td><td>10.7x</td><td style="text-align: right;">↑</td></tr> <tr><td>10:</td><td>10.4x</td><td style="text-align: right;">←</td></tr> <tr><td colspan="2"><b>Serie</b></td><td style="text-align: right;"><b>99.0</b></td></tr> <tr><td colspan="2"><b>Total</b></td><td style="text-align: right;"><b>99.0</b></td></tr> </table>	1:	10.1	→	2:	10.6x	↑	3:	10.2x	↘	4:	10.7x	↗	5:	10.9x	↗	6:	10.3x	↑	7:	10.7x	→	8:	9.8	↘	9:	10.7x	↑	10:	10.4x	←	<b>Serie</b>		<b>99.0</b>	<b>Total</b>		<b>99.0</b>
1:	10.1	→																																			
2:	10.6x	↑																																			
3:	10.2x	↘																																			
4:	10.7x	↗																																			
5:	10.9x	↗																																			
6:	10.3x	↑																																			
7:	10.7x	→																																			
8:	9.8	↘																																			
9:	10.7x	↑																																			
10:	10.4x	←																																			
<b>Serie</b>		<b>99.0</b>																																			
<b>Total</b>		<b>99.0</b>																																			
<p><b>Serie 2</b></p> 	<table style="width:100%; border-collapse: collapse;"> <tr><td style="width:5%;">1:</td><td style="width:15%;">10.8x</td><td style="width:10%; text-align: right;">↑</td></tr> <tr><td>2:</td><td>10.3x</td><td style="text-align: right;">↓</td></tr> <tr><td>3:</td><td>10.5x</td><td style="text-align: right;">←</td></tr> <tr><td>4:</td><td>10.1</td><td style="text-align: right;">←</td></tr> <tr><td>5:</td><td>9.4</td><td style="text-align: right;">↙</td></tr> <tr><td>6:</td><td>10.5x</td><td style="text-align: right;">↗</td></tr> <tr><td>7:</td><td>10.3x</td><td style="text-align: right;">↓</td></tr> <tr><td>8:</td><td>10.4x</td><td style="text-align: right;">↘</td></tr> <tr><td>9:</td><td>10.1</td><td style="text-align: right;">↓</td></tr> <tr><td>10:</td><td>10.1</td><td style="text-align: right;">↗</td></tr> <tr><td colspan="2"><b>Serie</b></td><td style="text-align: right;"><b>99.0</b></td></tr> <tr><td colspan="2"><b>Total</b></td><td style="text-align: right;"><b>198.0</b></td></tr> </table>	1:	10.8x	↑	2:	10.3x	↓	3:	10.5x	←	4:	10.1	←	5:	9.4	↙	6:	10.5x	↗	7:	10.3x	↓	8:	10.4x	↘	9:	10.1	↓	10:	10.1	↗	<b>Serie</b>		<b>99.0</b>	<b>Total</b>		<b>198.0</b>
1:	10.8x	↑																																			
2:	10.3x	↓																																			
3:	10.5x	←																																			
4:	10.1	←																																			
5:	9.4	↙																																			
6:	10.5x	↗																																			
7:	10.3x	↓																																			
8:	10.4x	↘																																			
9:	10.1	↓																																			
10:	10.1	↗																																			
<b>Serie</b>		<b>99.0</b>																																			
<b>Total</b>		<b>198.0</b>																																			
<p><b>Serie 3</b></p> 	<table style="width:100%; border-collapse: collapse;"> <tr><td style="width:5%;">1:</td><td style="width:15%;">10.3x</td><td style="width:10%; text-align: right;">←</td></tr> <tr><td>2:</td><td>10.6x</td><td style="text-align: right;">→</td></tr> <tr><td>3:</td><td>10.8x</td><td style="text-align: right;">↑</td></tr> <tr><td>4:</td><td>9.9</td><td style="text-align: right;">↙</td></tr> <tr><td>5:</td><td>10.0</td><td style="text-align: right;">↓</td></tr> <tr><td>6:</td><td>10.7x</td><td style="text-align: right;">↑</td></tr> <tr><td>7:</td><td>10.6x</td><td style="text-align: right;">→</td></tr> <tr><td>8:</td><td>10.1</td><td style="text-align: right;">↘</td></tr> <tr><td>9:</td><td>10.2x</td><td style="text-align: right;">↗</td></tr> <tr><td>10:</td><td>10.8x</td><td style="text-align: right;">↑</td></tr> <tr><td colspan="2"><b>Serie</b></td><td style="text-align: right;"><b>99.0</b></td></tr> <tr><td colspan="2"><b>Total</b></td><td style="text-align: right;"><b>297.0</b></td></tr> </table>	1:	10.3x	←	2:	10.6x	→	3:	10.8x	↑	4:	9.9	↙	5:	10.0	↓	6:	10.7x	↑	7:	10.6x	→	8:	10.1	↘	9:	10.2x	↗	10:	10.8x	↑	<b>Serie</b>		<b>99.0</b>	<b>Total</b>		<b>297.0</b>
1:	10.3x	←																																			
2:	10.6x	→																																			
3:	10.8x	↑																																			
4:	9.9	↙																																			
5:	10.0	↓																																			
6:	10.7x	↑																																			
7:	10.6x	→																																			
8:	10.1	↘																																			
9:	10.2x	↗																																			
10:	10.8x	↑																																			
<b>Serie</b>		<b>99.0</b>																																			
<b>Total</b>		<b>297.0</b>																																			

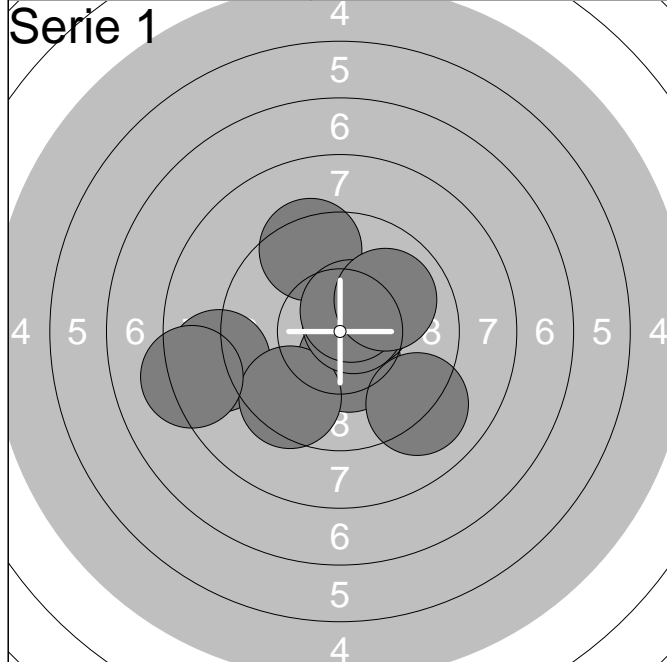

1:	9.4	↗
2:	8.8	←
3:	10.4x	↓
4:	10.5x	↗
5:	9.5	↘
6:	10.6x	↗
7:	9.1	↘
8:	8.2	←
9:	10.5x	↗
10:	9.9	↗
<b>Serie</b>	<b>92.0</b>	
<b>Total</b>	<b>92.0</b>	



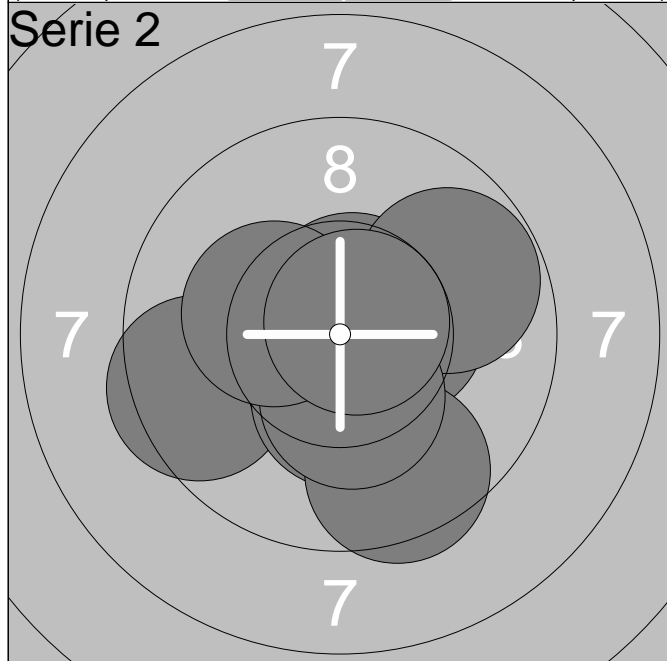

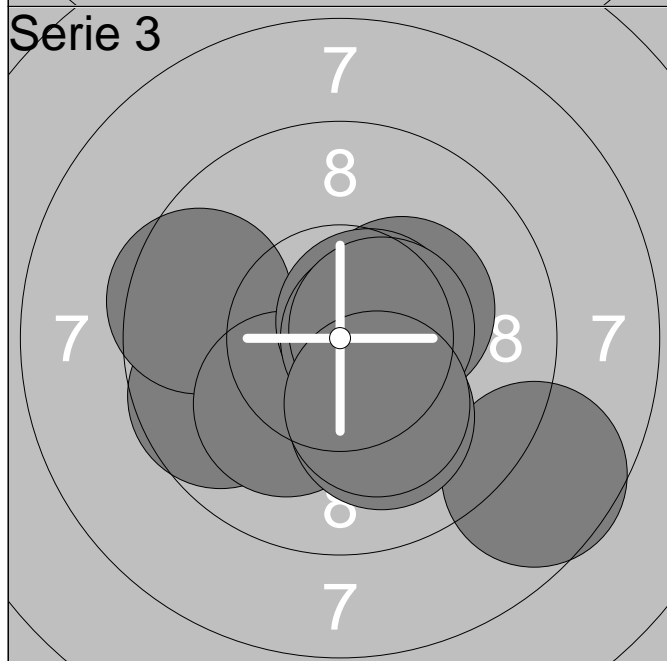
1:	9.5	←
2:	10.6x	↗
3:	10.5x	↓
4:	10.4x	→
5:	10.3x	↓
6:	9.8	↗
7:	9.5	↓
8:	10.3x	↓
9:	10.3x	←
10:	10.7x	↗
<b>Serie</b>	<b>97.0</b>	
<b>Total</b>	<b>189.0</b>	



1:	9.6	←
2:	9.5	←
3:	10.1	↘
4:	10.3x	↗
5:	10.6x	↗
6:	10.6x	→
7:	8.6	↘
8:	10.1	↓
9:	10.5x	→
10:	10.2x	↓
<b>Serie</b>	<b>96.0</b>	
<b>Total</b>	<b>285.0</b>	

16.04.2015	Landsstevnet rekrutt 2015	LS Rekrutt 2015
------------	---------------------------	-----------------

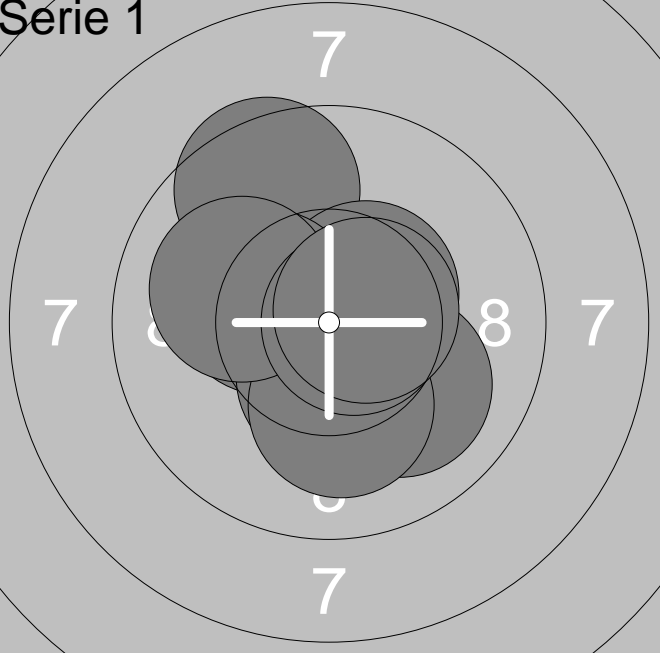
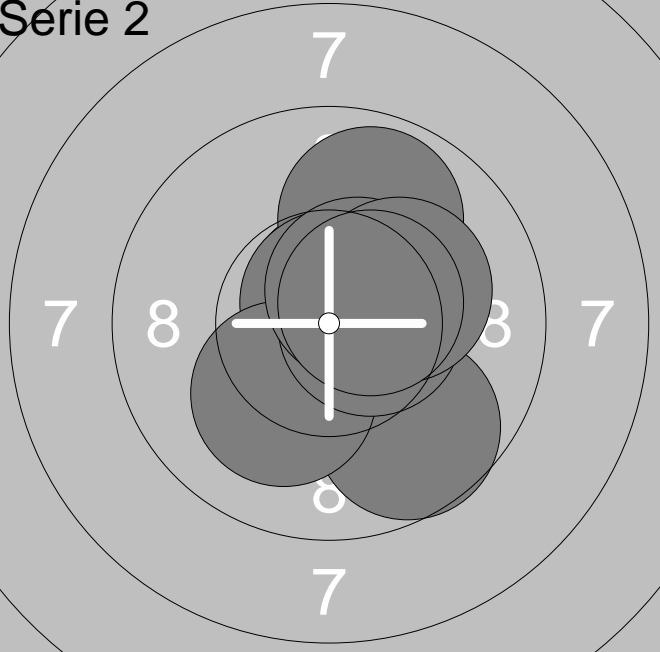

<b>Serie 1</b> 	<table style="width:100%; border-collapse: collapse;"> <tr><td style="width:10%;">1:</td><td style="width:30%;">9.5</td><td style="width:10%; text-align: center;">↗</td></tr> <tr><td>2:</td><td>10.0</td><td style="text-align: center;">↘</td></tr> <tr><td>3:</td><td>10.8x</td><td style="text-align: center;">↗</td></tr> <tr><td>4:</td><td>10.5x</td><td style="text-align: center;">↗</td></tr> <tr><td>5:</td><td>10.3x</td><td style="text-align: center;">↖</td></tr> <tr><td>6:</td><td>10.4x</td><td style="text-align: center;">↓</td></tr> <tr><td>7:</td><td>10.1</td><td style="text-align: center;">↓</td></tr> <tr><td>8:</td><td>10.0</td><td style="text-align: center;">↖</td></tr> <tr><td>9:</td><td>10.7x</td><td style="text-align: center;">→</td></tr> <tr><td>10:</td><td>10.5x</td><td style="text-align: center;">→</td></tr> <tr><td colspan="2"><b>Serie</b></td><td style="text-align: right;"><b>99.0</b></td></tr> <tr><td colspan="2"><b>Total</b></td><td style="text-align: right;"><b>99.0</b></td></tr> </table>	1:	9.5	↗	2:	10.0	↘	3:	10.8x	↗	4:	10.5x	↗	5:	10.3x	↖	6:	10.4x	↓	7:	10.1	↓	8:	10.0	↖	9:	10.7x	→	10:	10.5x	→	<b>Serie</b>		<b>99.0</b>	<b>Total</b>		<b>99.0</b>
1:	9.5	↗																																			
2:	10.0	↘																																			
3:	10.8x	↗																																			
4:	10.5x	↗																																			
5:	10.3x	↖																																			
6:	10.4x	↓																																			
7:	10.1	↓																																			
8:	10.0	↖																																			
9:	10.7x	→																																			
10:	10.5x	→																																			
<b>Serie</b>		<b>99.0</b>																																			
<b>Total</b>		<b>99.0</b>																																			
<b>Serie 2</b> 	<table style="width:100%; border-collapse: collapse;"> <tr><td style="width:10%;">1:</td><td style="width:30%;">10.7x</td><td style="width:10%; text-align: center;">↗</td></tr> <tr><td>2:</td><td>9.9</td><td style="text-align: center;">↗</td></tr> <tr><td>3:</td><td>10.5x</td><td style="text-align: center;">↗</td></tr> <tr><td>4:</td><td>10.7x</td><td style="text-align: center;">↗</td></tr> <tr><td>5:</td><td>9.7</td><td style="text-align: center;">↘</td></tr> <tr><td>6:</td><td>10.1</td><td style="text-align: center;">↘</td></tr> <tr><td>7:</td><td>10.5x</td><td style="text-align: center;">→</td></tr> <tr><td>8:</td><td>10.5x</td><td style="text-align: center;">↗</td></tr> <tr><td>9:</td><td>10.2x</td><td style="text-align: center;">→</td></tr> <tr><td>10:</td><td>10.5x</td><td style="text-align: center;">↗</td></tr> <tr><td colspan="2"><b>Serie</b></td><td style="text-align: right;"><b>98.0</b></td></tr> <tr><td colspan="2"><b>Total</b></td><td style="text-align: right;"><b>197.0</b></td></tr> </table>	1:	10.7x	↗	2:	9.9	↗	3:	10.5x	↗	4:	10.7x	↗	5:	9.7	↘	6:	10.1	↘	7:	10.5x	→	8:	10.5x	↗	9:	10.2x	→	10:	10.5x	↗	<b>Serie</b>		<b>98.0</b>	<b>Total</b>		<b>197.0</b>
1:	10.7x	↗																																			
2:	9.9	↗																																			
3:	10.5x	↗																																			
4:	10.7x	↗																																			
5:	9.7	↘																																			
6:	10.1	↘																																			
7:	10.5x	→																																			
8:	10.5x	↗																																			
9:	10.2x	→																																			
10:	10.5x	↗																																			
<b>Serie</b>		<b>98.0</b>																																			
<b>Total</b>		<b>197.0</b>																																			
<b>Serie 3</b> 	<table style="width:100%; border-collapse: collapse;"> <tr><td style="width:10%;">1:</td><td style="width:30%;">10.8x</td><td style="width:10%; text-align: center;">→</td></tr> <tr><td>2:</td><td>9.8</td><td style="text-align: center;">↖</td></tr> <tr><td>3:</td><td>10.3x</td><td style="text-align: center;">↖</td></tr> <tr><td>4:</td><td>10.2x</td><td style="text-align: center;">↓</td></tr> <tr><td>5:</td><td>10.8x</td><td style="text-align: center;">↗</td></tr> <tr><td>6:</td><td>10.2x</td><td style="text-align: center;">→</td></tr> <tr><td>7:</td><td>10.5x</td><td style="text-align: center;">→</td></tr> <tr><td>8:</td><td>10.5x</td><td style="text-align: center;">↗</td></tr> <tr><td>9:</td><td>10.8x</td><td style="text-align: center;">↗</td></tr> <tr><td>10:</td><td>10.3x</td><td style="text-align: center;">↓</td></tr> <tr><td colspan="2"><b>Serie</b></td><td style="text-align: right;"><b>99.0</b></td></tr> <tr><td colspan="2"><b>Total</b></td><td style="text-align: right;"><b>296.0</b></td></tr> </table>	1:	10.8x	→	2:	9.8	↖	3:	10.3x	↖	4:	10.2x	↓	5:	10.8x	↗	6:	10.2x	→	7:	10.5x	→	8:	10.5x	↗	9:	10.8x	↗	10:	10.3x	↓	<b>Serie</b>		<b>99.0</b>	<b>Total</b>		<b>296.0</b>
1:	10.8x	→																																			
2:	9.8	↖																																			
3:	10.3x	↖																																			
4:	10.2x	↓																																			
5:	10.8x	↗																																			
6:	10.2x	→																																			
7:	10.5x	→																																			
8:	10.5x	↗																																			
9:	10.8x	↗																																			
10:	10.3x	↓																																			
<b>Serie</b>		<b>99.0</b>																																			
<b>Total</b>		<b>296.0</b>																																			

16.04.2015	Landsstevnet rekrutt 2015	LS Rekrutt 2015
------------	---------------------------	-----------------

<p><b>Serie 1</b></p>	<table style="width:100%; border-collapse: collapse;"> <tr><td style="width:5%;">1:</td><td style="width:15%;">9.9</td><td style="width:10%; text-align:right;">→</td></tr> <tr><td>2:</td><td>10.4x</td><td style="text-align:right;">↘</td></tr> <tr><td>3:</td><td>10.5x</td><td style="text-align:right;">↗</td></tr> <tr><td>4:</td><td>10.7x</td><td style="text-align:right;">↑</td></tr> <tr><td>5:</td><td>10.4x</td><td style="text-align:right;">↗</td></tr> <tr><td>6:</td><td>9.7</td><td style="text-align:right;">→</td></tr> <tr><td>7:</td><td>10.2x</td><td style="text-align:right;">↘</td></tr> <tr><td>8:</td><td>10.8x</td><td style="text-align:right;">→</td></tr> <tr><td>9:</td><td>10.1</td><td style="text-align:right;">↘</td></tr> <tr><td>10:</td><td>10.6x</td><td style="text-align:right;">↗</td></tr> <tr><td colspan="2"><b>Serie</b></td><td style="text-align:right;"><b>98.0</b></td></tr> <tr><td colspan="2"><b>Total</b></td><td style="text-align:right;"><b>98.0</b></td></tr> </table>	1:	9.9	→	2:	10.4x	↘	3:	10.5x	↗	4:	10.7x	↑	5:	10.4x	↗	6:	9.7	→	7:	10.2x	↘	8:	10.8x	→	9:	10.1	↘	10:	10.6x	↗	<b>Serie</b>		<b>98.0</b>	<b>Total</b>		<b>98.0</b>
1:	9.9	→																																			
2:	10.4x	↘																																			
3:	10.5x	↗																																			
4:	10.7x	↑																																			
5:	10.4x	↗																																			
6:	9.7	→																																			
7:	10.2x	↘																																			
8:	10.8x	→																																			
9:	10.1	↘																																			
10:	10.6x	↗																																			
<b>Serie</b>		<b>98.0</b>																																			
<b>Total</b>		<b>98.0</b>																																			
<p><b>Serie 2</b></p>	<table style="width:100%; border-collapse: collapse;"> <tr><td style="width:5%;">1:</td><td style="width:15%;">10.1</td><td style="width:10%; text-align:right;">→</td></tr> <tr><td>2:</td><td>10.1</td><td style="text-align:right;">↙</td></tr> <tr><td>3:</td><td>10.8x</td><td style="text-align:right;">↗</td></tr> <tr><td>4:</td><td>10.1</td><td style="text-align:right;">↘</td></tr> <tr><td>5:</td><td>10.6x</td><td style="text-align:right;">→</td></tr> <tr><td>6:</td><td>9.6</td><td style="text-align:right;">↘</td></tr> <tr><td>7:</td><td>9.6</td><td style="text-align:right;">↙</td></tr> <tr><td>8:</td><td>9.8</td><td style="text-align:right;">→</td></tr> <tr><td>9:</td><td>10.0</td><td style="text-align:right;">↘</td></tr> <tr><td>10:</td><td>10.7x</td><td style="text-align:right;">→</td></tr> <tr><td colspan="2"><b>Serie</b></td><td style="text-align:right;"><b>97.0</b></td></tr> <tr><td colspan="2"><b>Total</b></td><td style="text-align:right;"><b>195.0</b></td></tr> </table>	1:	10.1	→	2:	10.1	↙	3:	10.8x	↗	4:	10.1	↘	5:	10.6x	→	6:	9.6	↘	7:	9.6	↙	8:	9.8	→	9:	10.0	↘	10:	10.7x	→	<b>Serie</b>		<b>97.0</b>	<b>Total</b>		<b>195.0</b>
1:	10.1	→																																			
2:	10.1	↙																																			
3:	10.8x	↗																																			
4:	10.1	↘																																			
5:	10.6x	→																																			
6:	9.6	↘																																			
7:	9.6	↙																																			
8:	9.8	→																																			
9:	10.0	↘																																			
10:	10.7x	→																																			
<b>Serie</b>		<b>97.0</b>																																			
<b>Total</b>		<b>195.0</b>																																			
<p><b>Serie 3</b></p>	<table style="width:100%; border-collapse: collapse;"> <tr><td style="width:5%;">1:</td><td style="width:15%;">10.5x</td><td style="width:10%; text-align:right;">←</td></tr> <tr><td>2:</td><td>9.5</td><td style="text-align:right;">↘</td></tr> <tr><td>3:</td><td>10.0</td><td style="text-align:right;">↘</td></tr> <tr><td>4:</td><td>10.5x</td><td style="text-align:right;">←</td></tr> <tr><td>5:</td><td>10.2x</td><td style="text-align:right;">↘</td></tr> <tr><td>6:</td><td>10.3x</td><td style="text-align:right;">←</td></tr> <tr><td>7:</td><td>10.4x</td><td style="text-align:right;">→</td></tr> <tr><td>8:</td><td>9.7</td><td style="text-align:right;">↘</td></tr> <tr><td>9:</td><td>10.4x</td><td style="text-align:right;">↗</td></tr> <tr><td>10:</td><td>10.8x</td><td style="text-align:right;">↗</td></tr> <tr><td colspan="2"><b>Serie</b></td><td style="text-align:right;"><b>98.0</b></td></tr> <tr><td colspan="2"><b>Total</b></td><td style="text-align:right;"><b>293.0</b></td></tr> </table>	1:	10.5x	←	2:	9.5	↘	3:	10.0	↘	4:	10.5x	←	5:	10.2x	↘	6:	10.3x	←	7:	10.4x	→	8:	9.7	↘	9:	10.4x	↗	10:	10.8x	↗	<b>Serie</b>		<b>98.0</b>	<b>Total</b>		<b>293.0</b>
1:	10.5x	←																																			
2:	9.5	↘																																			
3:	10.0	↘																																			
4:	10.5x	←																																			
5:	10.2x	↘																																			
6:	10.3x	←																																			
7:	10.4x	→																																			
8:	9.7	↘																																			
9:	10.4x	↗																																			
10:	10.8x	↗																																			
<b>Serie</b>		<b>98.0</b>																																			
<b>Total</b>		<b>293.0</b>																																			

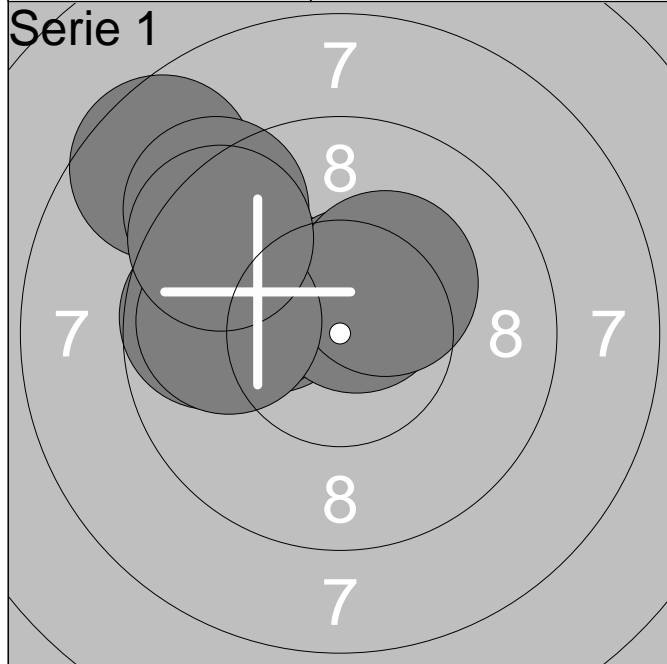

1:	8.6	↗
2:	10.2x	↗
3:	10.0	↗
4:	9.8	↗
5:	10.6x	↗
6:	9.7	↖
7:	10.3x	↗
8:	9.8	↖
9:	9.2	↗
10:	9.5	↗
<b>Serie</b>		<b>93.0</b>
<b>Total</b>		<b>93.0</b>

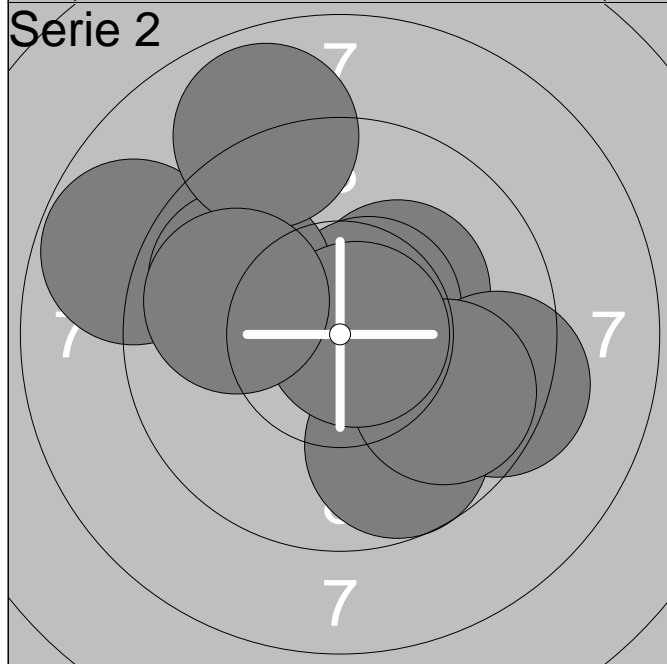

1:	10.2x	↗
2:	10.6x	↗
3:	8.8	↗
4:	9.3	↘
5:	9.7	↘
6:	9.8	↗
7:	9.8	↘
8:	10.8x	→
9:	8.9	↗
10:	9.9	↖
<b>Serie</b>		<b>91.0</b>
<b>Total</b>		<b>184.0</b>

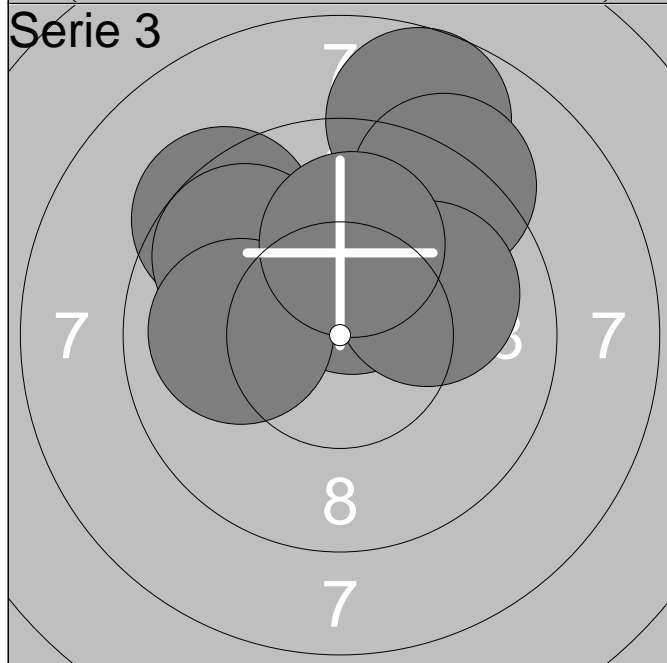

1:	10.0	↗
2:	9.3	↗
3:	10.2x	↗
4:	8.7	↗
5:	10.4x	↗
6:	9.2	↗
7:	10.0	↗
8:	9.7	↗
9:	10.0	↖
10:	10.0	↗
<b>Serie</b>		<b>95.0</b>
<b>Total</b>		<b>279.0</b>

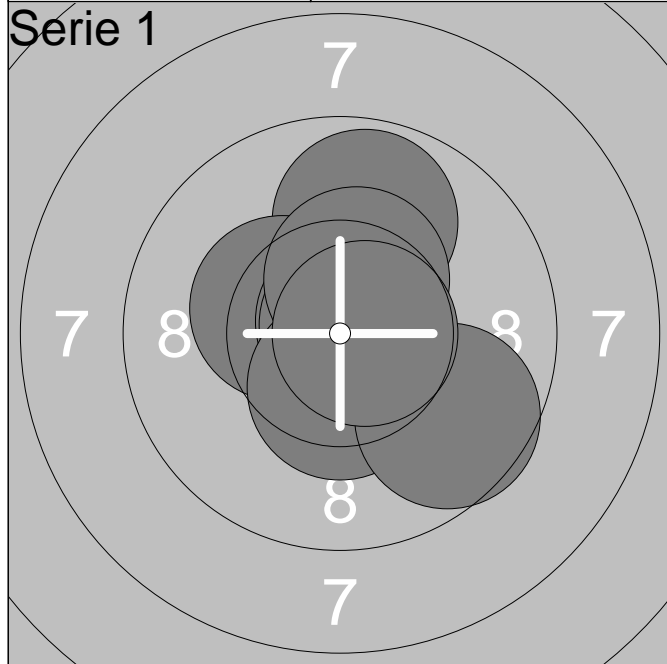

1:	10.7x	↑
2:	9.8	↑
3:	10.3x	↖
4:	10.8x	↗
5:	10.7x	→
6:	10.8x	↗
7:	10.4x	↑
8:	10.4x	↓
9:	9.6	↘
10:	10.7x	→
<b>Serie</b>		<b>98.0</b>
<b>Total</b>		<b>98.0</b>

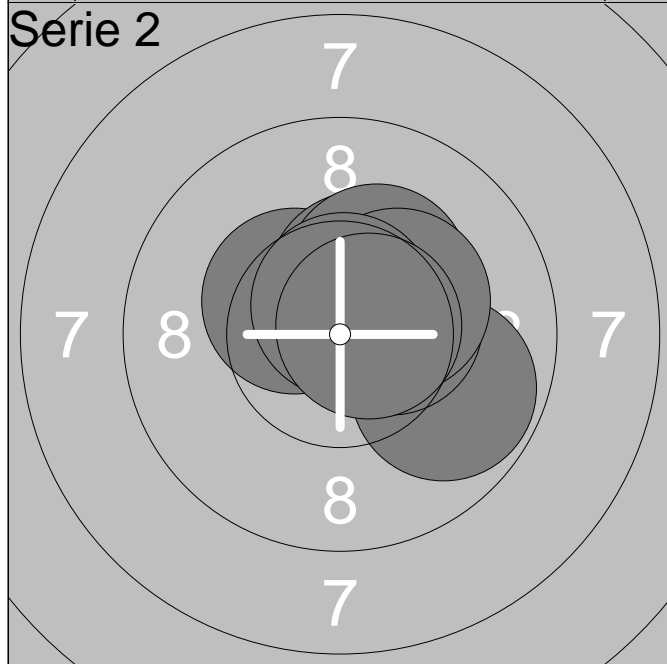

1:	10.5x	↗
2:	9.8	↘
3:	10.4x	↖
4:	10.4x	→
5:	10.4x	↗
6:	10.4x	↑
7:	10.3x	↗
8:	10.3x	↗
9:	10.7x	↑
10:	10.6x	→
<b>Serie</b>		<b>99.0</b>
<b>Total</b>		<b>197.0</b>

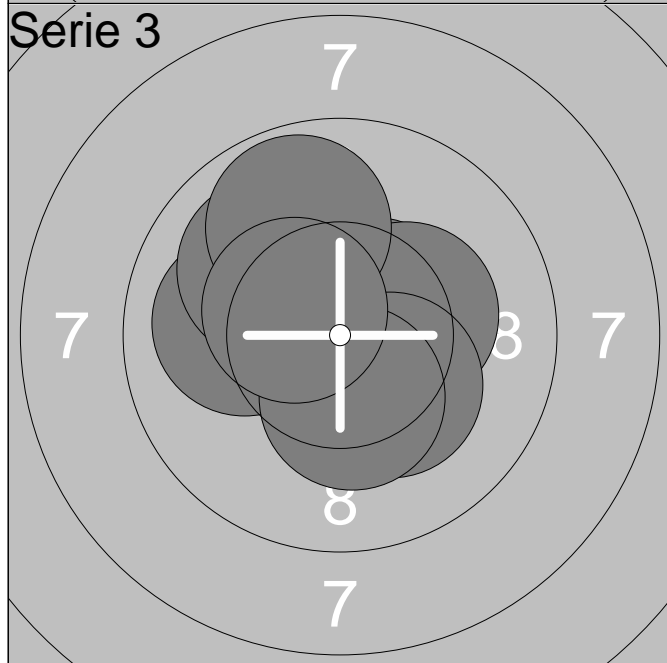

1:	10.5x	↗
2:	10.0	↖
3:	10.5x	↓
4:	10.7x	↑
5:	10.2x	→
6:	10.3x	↘
7:	10.0	↗
8:	9.8	↑
9:	10.3x	↓
10:	10.4x	↖
<b>Serie</b>		<b>99.0</b>
<b>Total</b>		<b>296.0</b>

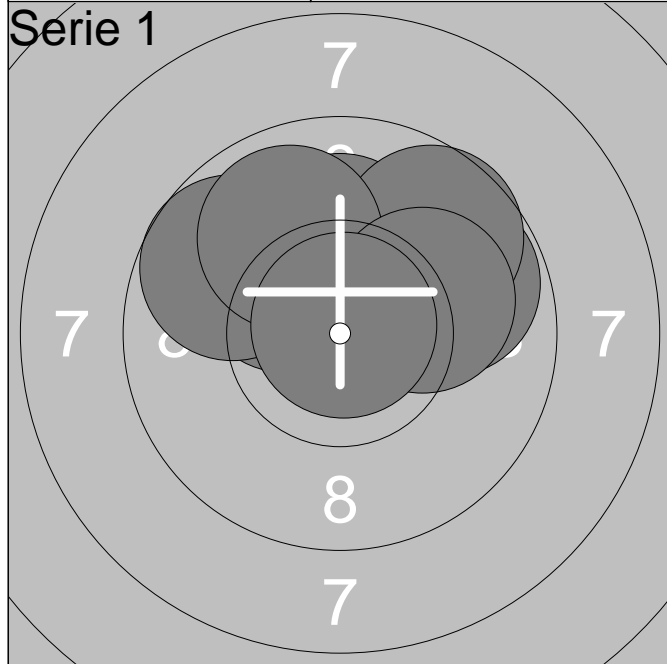

1:	10.2x	↖
2:	9.8	→
3:	10.2x	↗
4:	9.7	↖
5:	10.1	↑
6:	10.2x	↗
7:	9.6	↗
8:	9.9	↖
9:	10.1	↗
10:	10.8x	↗

Serie	96.0
Total	96.0

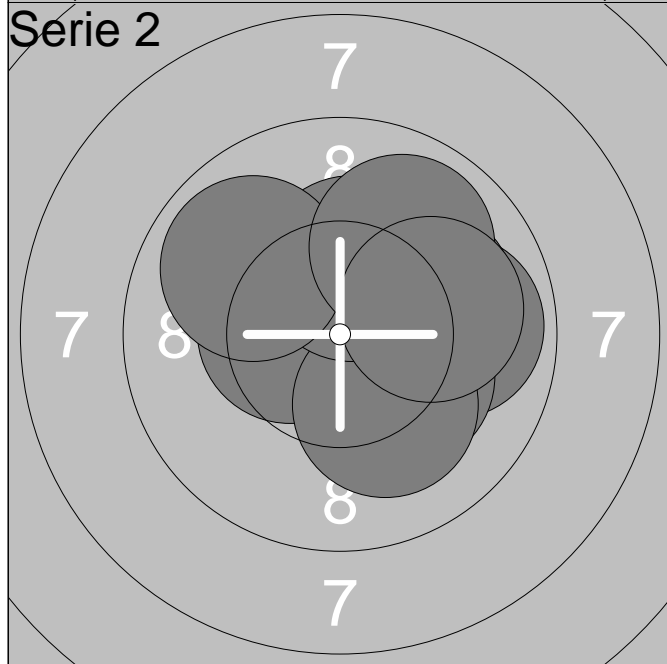

1:	10.7x	→
2:	9.9	→
3:	10.1	↗
4:	10.2x	↘
5:	10.5x	←
6:	10.1	↘
7:	10.3x	↑
8:	9.9	↖
9:	9.9	↗
10:	10.0	→

Serie	97.0
Total	193.0

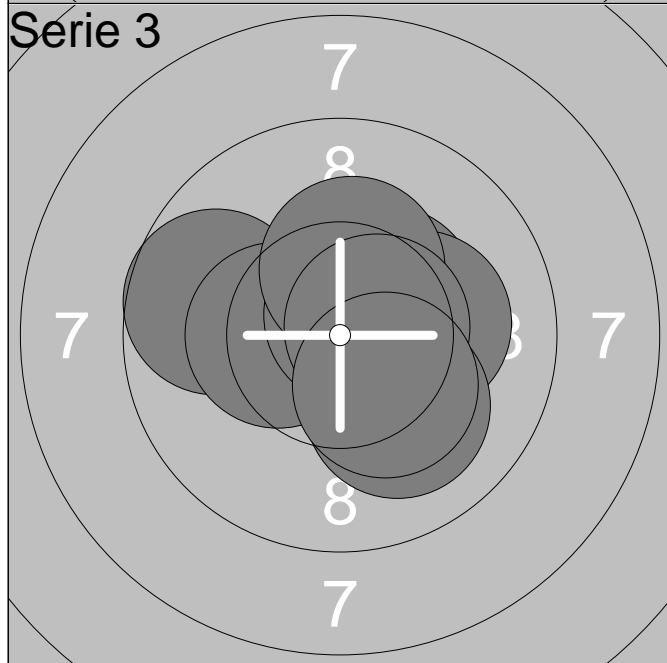

1:	9.7	←
2:	10.6x	→
3:	10.4x	↗
4:	10.3x	←
5:	10.7x	↗
6:	10.1	→
7:	10.3x	↑
8:	10.6x	→
9:	10.1	↘
10:	10.3x	↘

Serie	99.0
Total	292.0

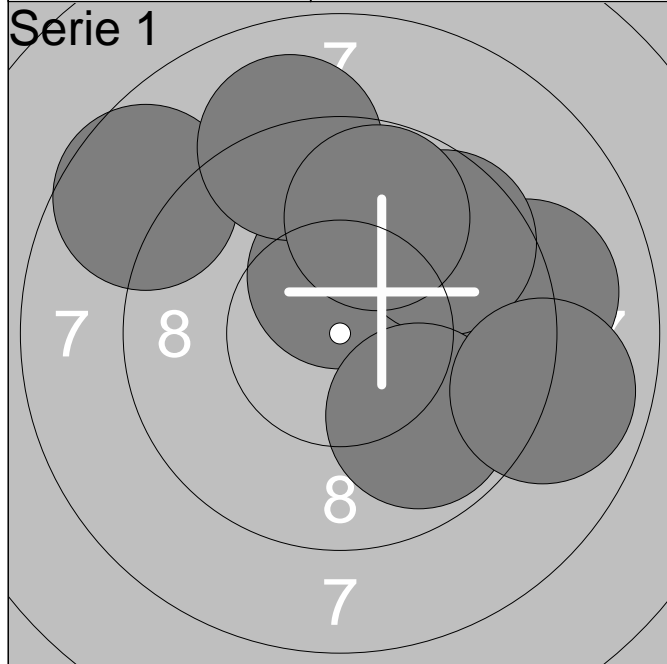

1:	8.6	↖
2:	9.5	→
3:	9.8	↗
4:	10.4x	↑
5:	9.1	→
6:	9.1	↑
7:	9.6	↗
8:	9.8	↘
9:	8.9	→
10:	9.7	↑
<b>Serie</b>	<b>89.0</b>	
<b>Total</b>	<b>89.0</b>	

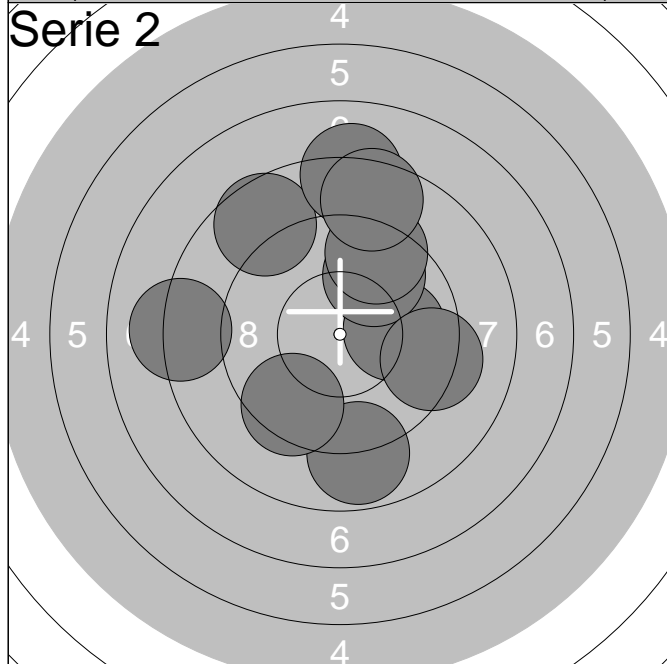

1:	8.8	↓
2:	10.0	→
3:	9.4	↙
4:	8.6	↖
5:	9.7	↗
6:	8.1	←
7:	9.4	↗
8:	8.1	↑
9:	8.5	↑
10:	9.3	→
<b>Serie</b>	<b>86.0</b>	
<b>Total</b>	<b>175.0</b>	

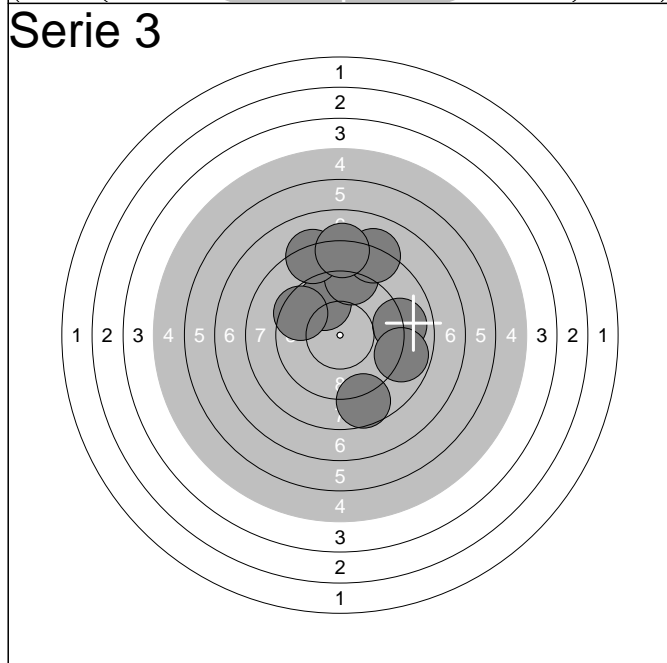

1:	9.8	↖
2:	8.6	↓
3:	8.9	→
4:	9.0	↑
5:	8.1	↗
6:	8.8	→
7:	8.2	↖
8:	0.0	→
9:	8.2	↑
10:	9.5	↖
<b>Serie</b>	<b>75.0</b>	
<b>Total</b>	<b>250.0</b>	



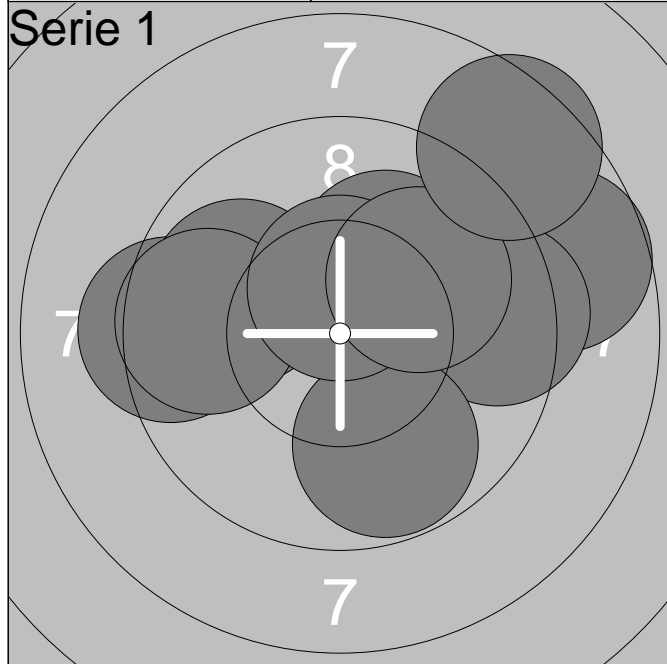

1:	9.3	←
2:	9.9	←
3:	9.6	←
4:	8.7	→
5:	9.4	→
6:	9.8	↓
7:	10.1	↗
8:	10.5x	↑
9:	10.0	↗
10:	8.5	↗
<b>Serie</b>		<b>91.0</b>
<b>Total</b>		<b>91.0</b>

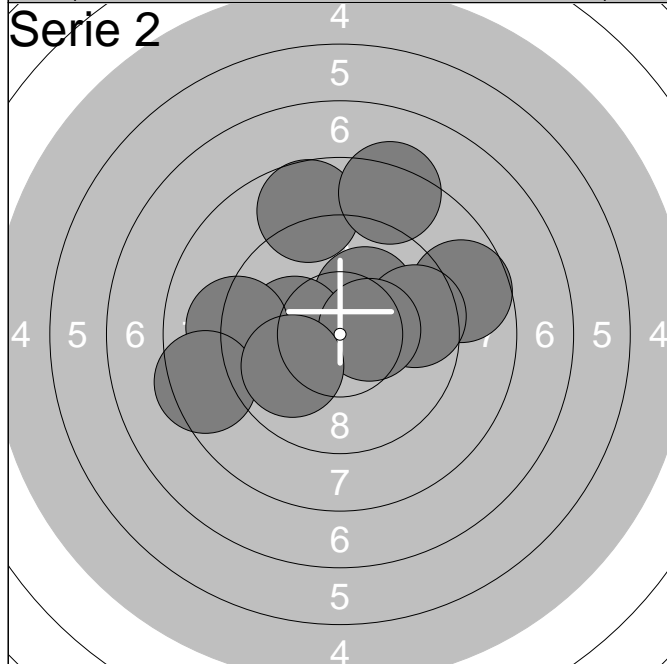

1:	8.7	→
2:	10.2x	↗
3:	10.1	←
4:	8.7	↑
5:	9.6	→
6:	9.1	←
7:	8.3	↑
8:	10.4x	→
9:	8.4	←
10:	9.9	↙
<b>Serie</b>		<b>89.0</b>
<b>Total</b>		<b>180.0</b>



1:	9.2	←
2:	10.0	←
3:	9.2	↑
4:	8.8	↗
5:	10.8x	↑
6:	10.4x	↑
7:	9.7	↓
8:	10.0	↑
9:	10.5x	↗
10:	8.5	↑
<b>Serie</b>		<b>93.0</b>
<b>Total</b>		<b>273.0</b>

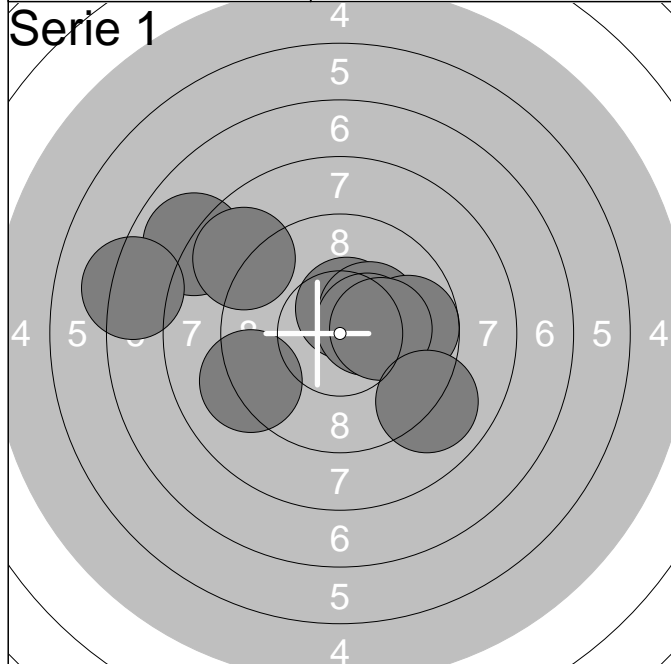

1:	10.5x	↑
2:	7.9	↖
3:	8.8	↖
4:	7.2	←
5:	9.2	↙
6:	10.3x	↗
7:	10.4x	→
8:	9.7	→
9:	10.2x	→
10:	9.0	↘
<b>Serie</b>		<b>89.0</b>
<b>Total</b>		<b>89.0</b>

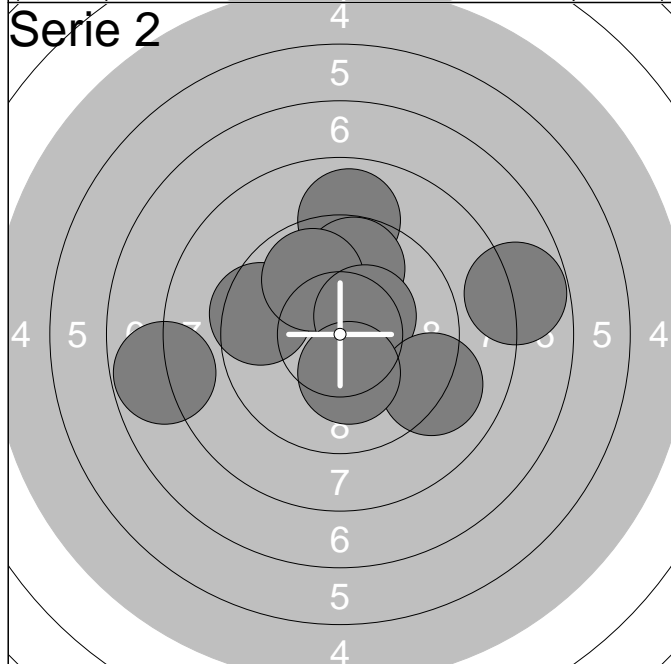

1:	8.9	↑
2:	9.5	←
3:	9.8	↑
4:	10.4x	↘
5:	7.8	→
6:	7.8	←
7:	9.8	↑
8:	10.4x	↗
9:	9.1	↘
10:	10.2x	↘
<b>Serie</b>		<b>88.0</b>
<b>Total</b>		<b>177.0</b>



1:	8.2	↘
2:	9.9	↘
3:	10.0	←
4:	8.1	↘
5:	9.2	←
6:	7.4	←
7:	9.2	←
8:	10.0	↗
9:	9.2	←
10:	8.9	←
<b>Serie</b>		<b>87.0</b>
<b>Total</b>		<b>264.0</b>

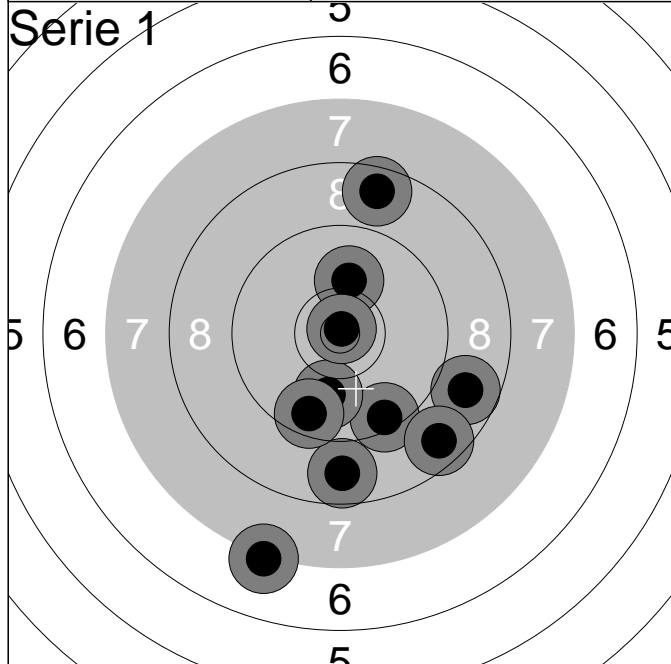

1:	8.7	↓
2:	9.4	↓
3:	8.6	↑
4:	10.0	↓
5:	8.7	→
6:	9.6	↓
7:	8.6	↓
8:	10.1	↑
9:	7.2	↓
10:	10.9x	↑
<b>Serie</b>		<b>87.0</b>
<b>Total</b>		<b>87.0</b>

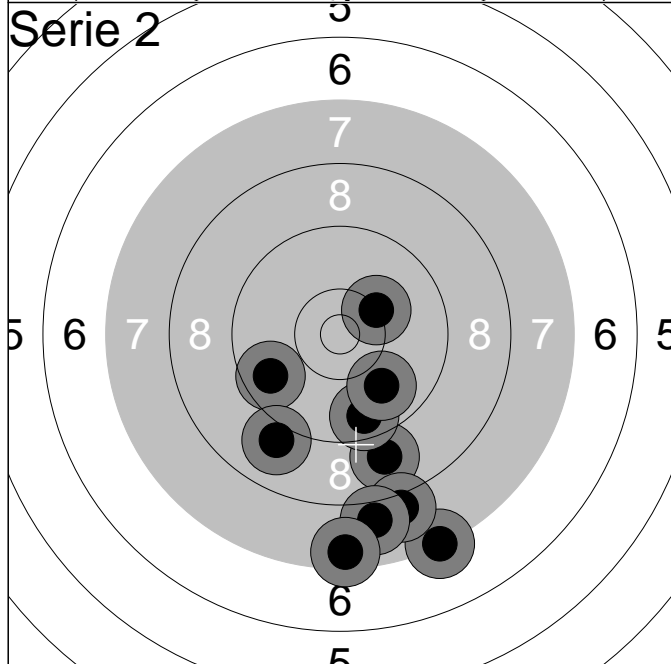

1:	7.3	↓
2:	8.9	↓
3:	9.7	↙
4:	8.0	↓
5:	7.9	↓
6:	10.3	↗
7:	7.5	↓
8:	9.6	↓
9:	9.0	↙
10:	9.9	↓
<b>Serie</b>		<b>83.0</b>
<b>Total</b>		<b>170.0</b>

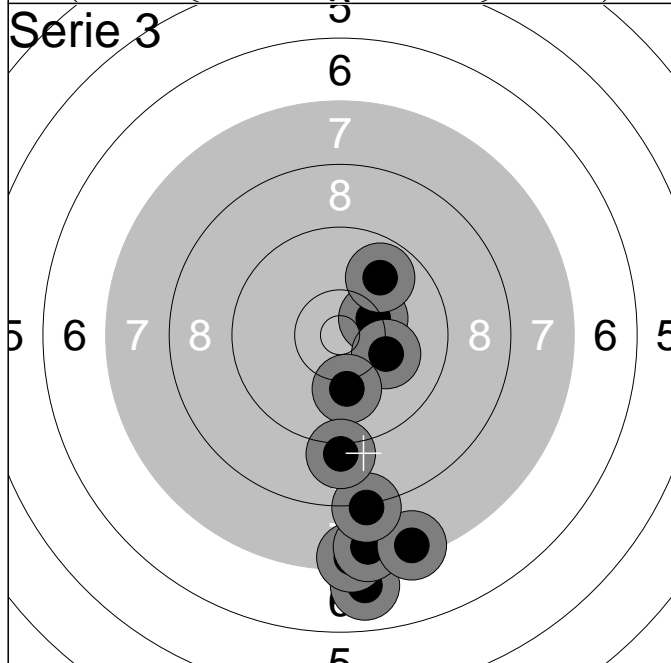

1:	6.9	↓
2:	7.4	↓
3:	7.6	↓
4:	7.4	↓
5:	10.4x	↗
6:	9.8	↗
7:	8.2	↓
8:	10.2	→
9:	10.1	↓
10:	9.1	↓
<b>Serie</b>		<b>83.0</b>
<b>Total</b>		<b>253.0</b>

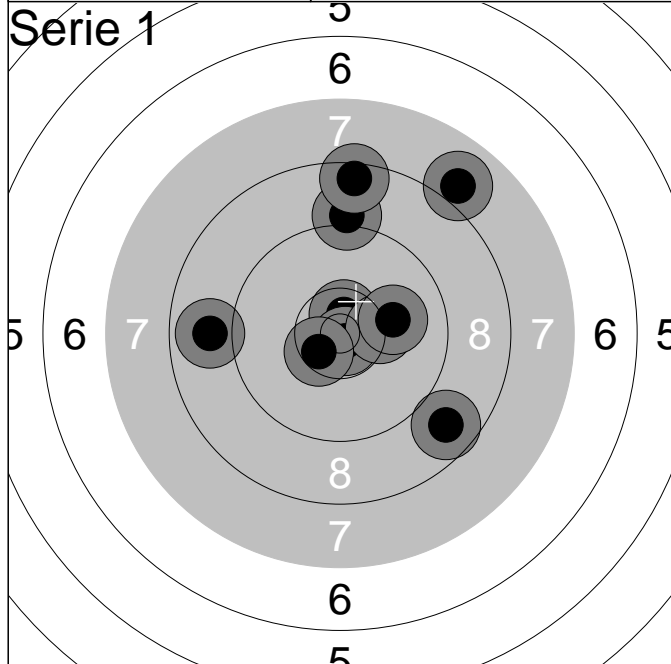

1:	10.6x	↑
2:	7.9	↗
3:	9.1	↑
4:	10.8x	↘
5:	10.3	→
6:	8.9	←
7:	10.1	→
8:	8.5	↑
9:	8.7	↘
10:	10.5x	↙
<b>Serie</b>		<b>90.0</b>
<b>Total</b>		<b>90.0</b>

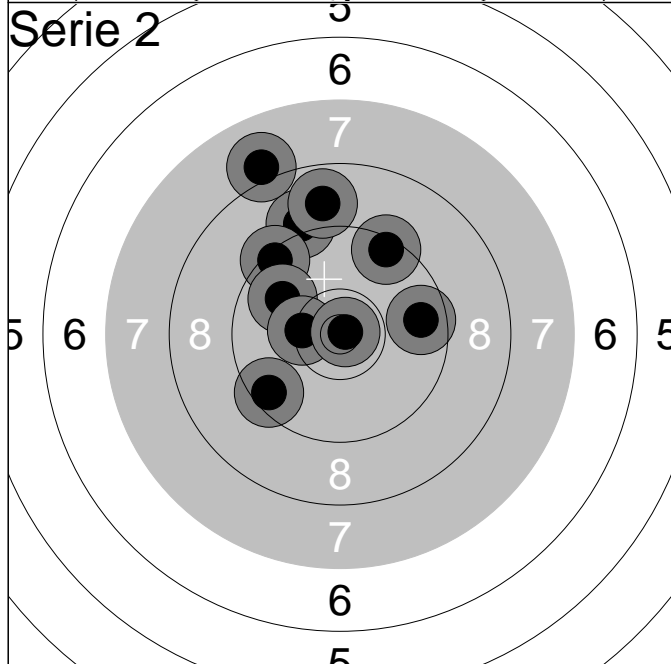

1:	9.1	↑
2:	8.0	↑
3:	9.5	↙
4:	9.4	↗
5:	9.6	→
6:	8.8	↑
7:	9.9	↗
8:	10.3	←
9:	9.4	↑
10:	10.8x	↗
<b>Serie</b>		<b>90.0</b>
<b>Total</b>		<b>180.0</b>

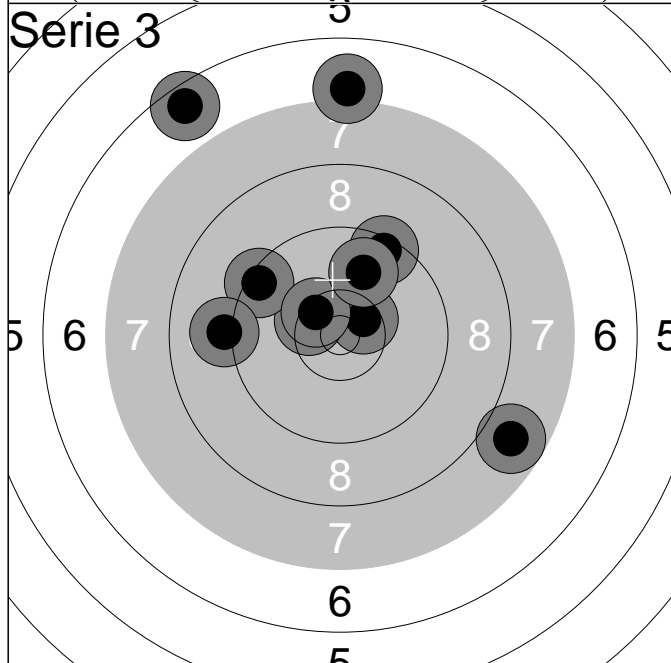

1:	9.4	↗
2:	7.8	↘
3:	10.5x	↗
4:	10.4x	↖
5:	9.4	↗
6:	10.4x	↗
7:	6.6	↗
8:	9.1	←
9:	9.9	↑
10:	7.0	↑
<b>Serie</b>		<b>86.0</b>
<b>Total</b>		<b>266.0</b>

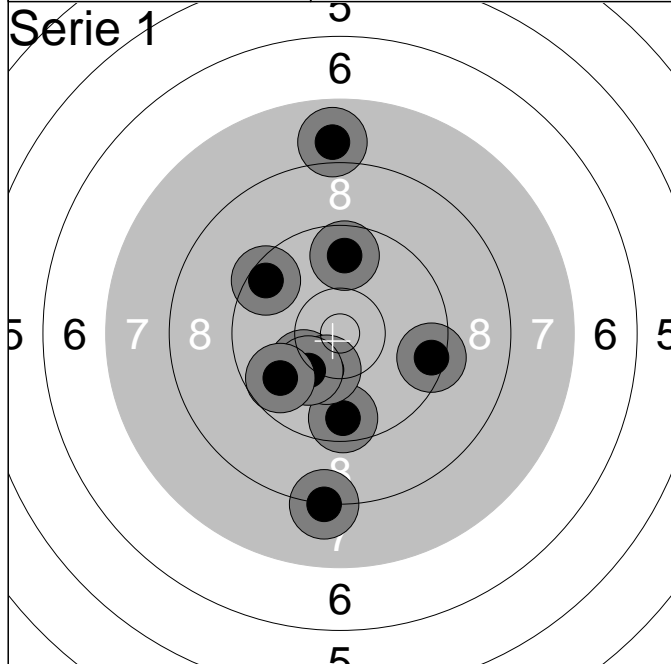

1:	8.2	↓
2:	10.2	↙
3:	9.7	↑
4:	9.4	→
5:	9.6	↓
6:	9.5	↗
7:	7.9	↑
8:	10.3	↓
9:	10.2	↙
10:	9.8	↙
<b>Serie</b>		<b>90.0</b>
<b>Total</b>		<b>90.0</b>

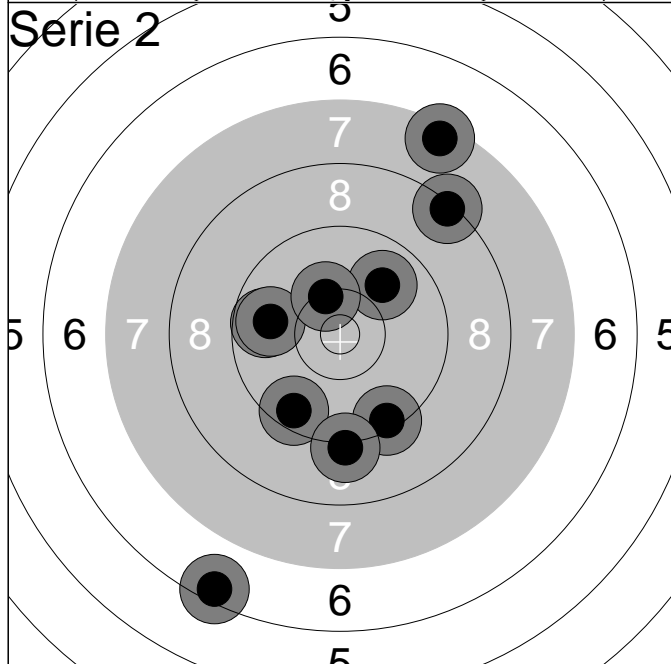

1:	9.7	←
2:	7.5	↗
3:	6.4	↙
4:	9.9	↗
5:	9.4	↓
6:	9.8	←
7:	8.3	↗
8:	9.5	↙
9:	9.1	↓
10:	10.3	↗
<b>Serie</b>		<b>85.0</b>
<b>Total</b>		<b>175.0</b>

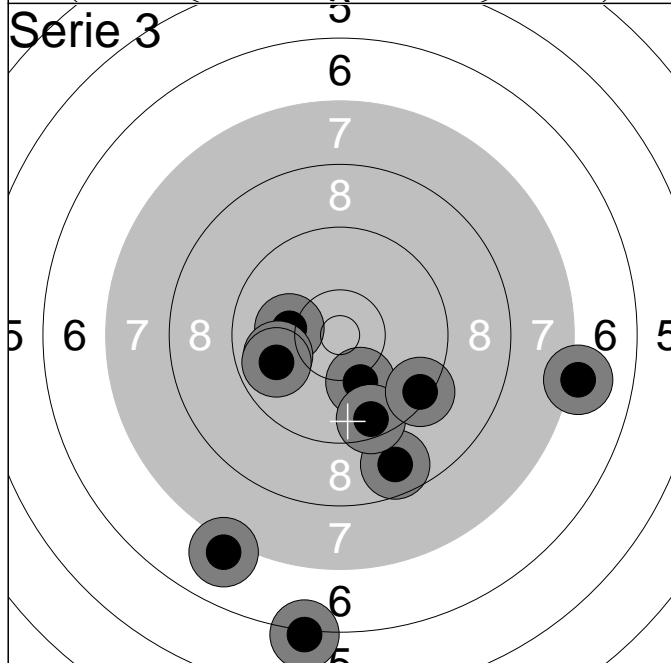

1:	10.1	←
2:	8.7	↓
3:	9.9	←
4:	10.1	↓
5:	7.1	→
6:	6.1	↓
7:	7.0	↙
8:	9.8	←
9:	9.5	↓
10:	9.4	↘
<b>Serie</b>		<b>84.0</b>
<b>Total</b>		<b>259.0</b>

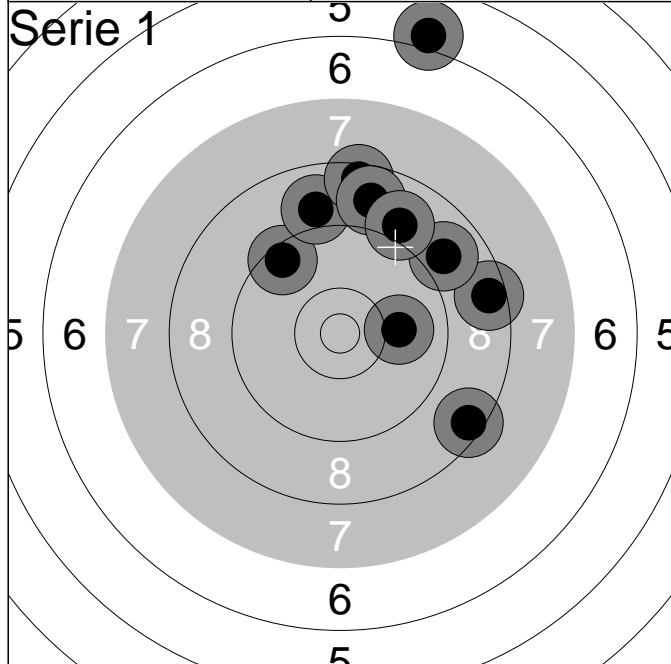

1:	6.0	↑
2:	9.5	↖
3:	8.9	↑
4:	8.5	↑
5:	8.8	↑
6:	8.5	↘
7:	8.5	→
8:	10.0	→
9:	8.9	↗
10:	9.0	↗
<b>Serie</b>		<b>82.0</b>
<b>Total</b>		<b>82.0</b>

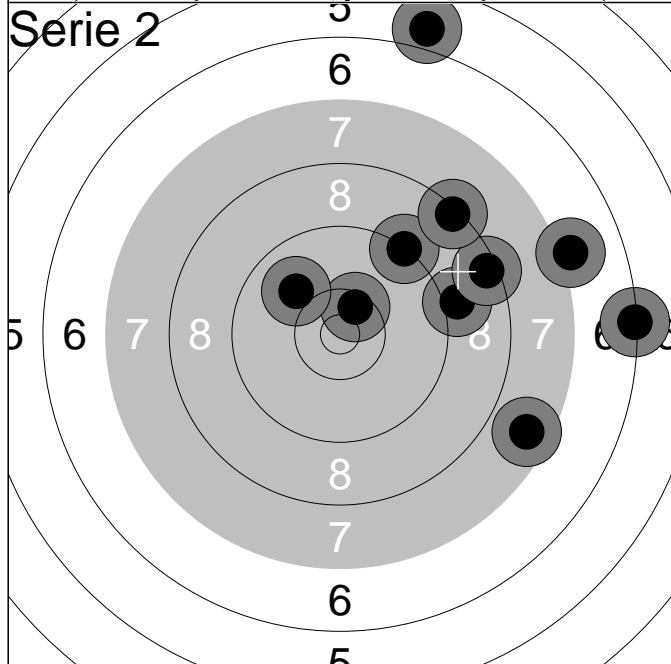

1:	9.0	→
2:	7.6	↘
3:	10.4x	↗
4:	8.4	→
5:	9.2	↗
6:	6.3	→
7:	7.1	→
8:	8.3	↗
9:	5.9	↑
10:	10.0	↖
<b>Serie</b>		<b>79.0</b>
<b>Total</b>		<b>161.0</b>

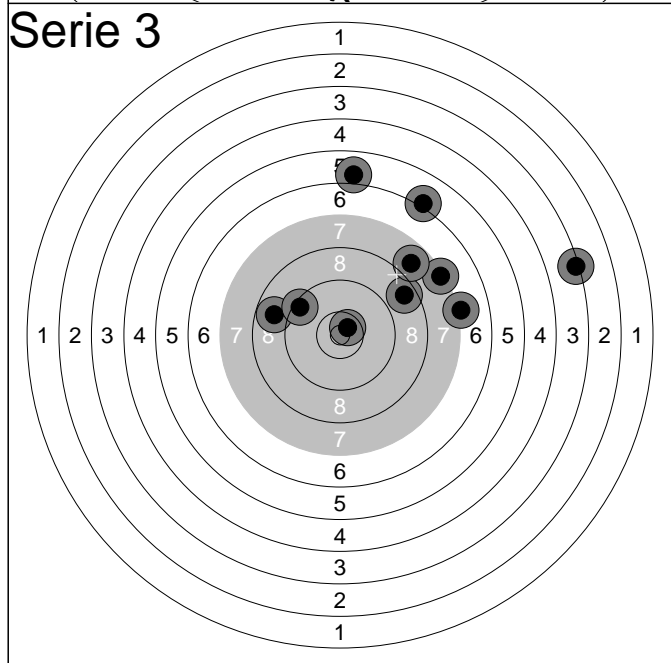

1:	6.1	↗
2:	8.8	↖
3:	10.6x	↗
4:	3.3	→
5:	8.6	↗
6:	7.3	↗
7:	7.1	→
8:	9.4	↖
9:	7.8	↗
10:	6.0	↑
<b>Serie</b>		<b>71.0</b>
<b>Total</b>		<b>232.0</b>

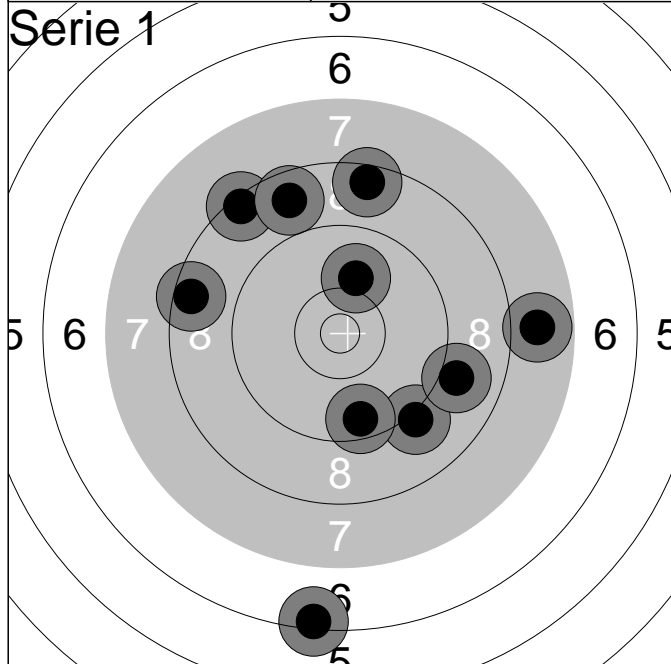

1:	8.4	↗
2:	8.5	↑
3:	7.8	→
4:	8.7	↗
5:	9.1	↘
6:	9.5	↘
7:	9.0	↘
8:	6.3	↘
9:	10.0	↑
10:	8.5	←
<b>Serie</b>		<b>82.0</b>
<b>Total</b>		<b>82.0</b>

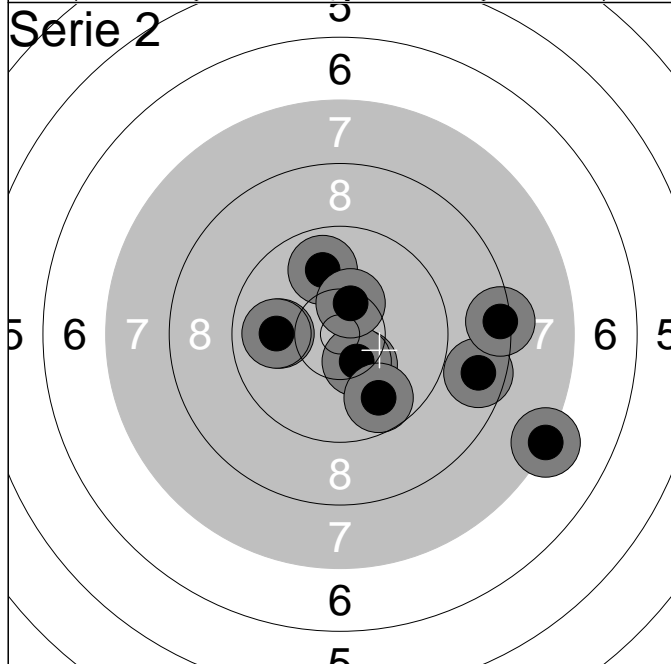

1:	10.3	↘
2:	8.7	→
3:	10.4x	↘
4:	7.3	↘
5:	10.0	←
6:	9.9	↑
7:	10.4x	↑
8:	9.9	←
9:	9.8	↘
10:	8.4	→
<b>Serie</b>		<b>90.0</b>
<b>Total</b>		<b>172.0</b>

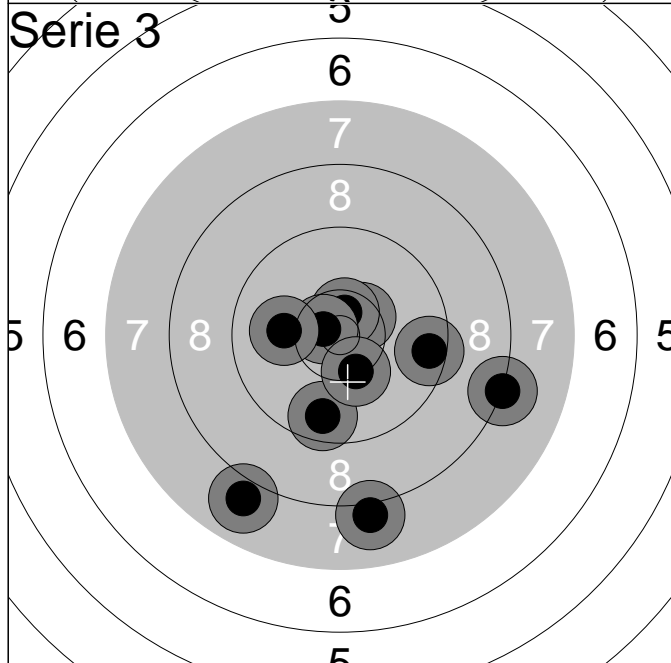

1:	7.9	↙
2:	10.5x	↗
3:	8.0	↘
4:	10.6x	↑
5:	9.6	↘
6:	8.2	→
7:	10.7x	↗
8:	10.3	↘
9:	10.1	←
10:	9.5	→
<b>Serie</b>		<b>91.0</b>
<b>Total</b>		<b>263.0</b>

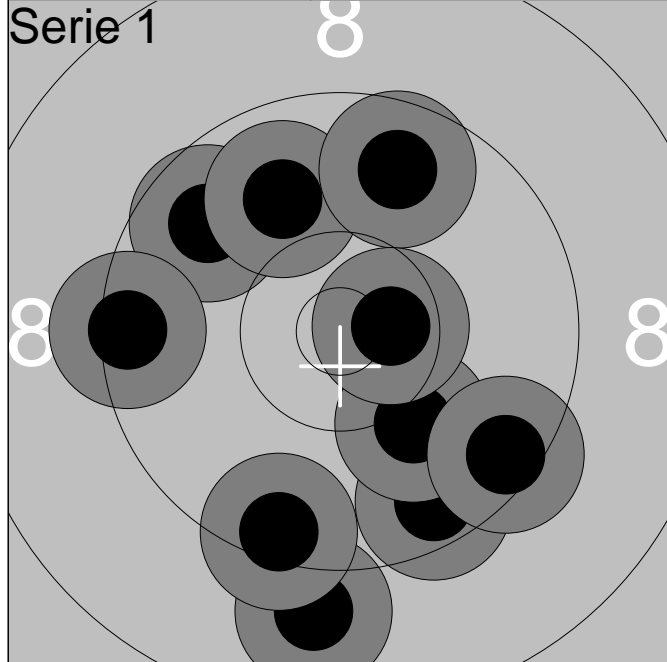

1:	9.6	↘
2:	10.1	↘
3:	9.5	↘
4:	9.7	↗
5:	9.9	↗
6:	8.9	↓
7:	9.4	↓
8:	9.7	↗
9:	9.4	←
10:	10.6x	→
<b>Serie</b>	<b>91.0</b>	
<b>Total</b>	<b>91.0</b>	

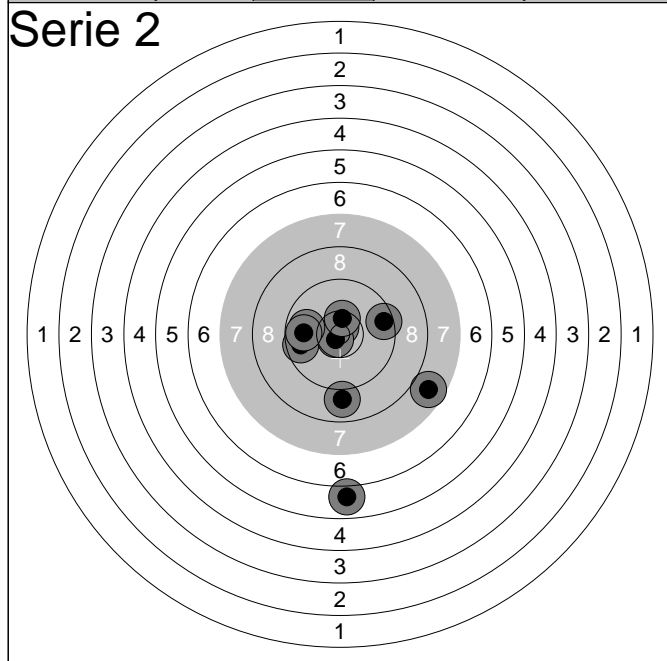

1:	9.7	←
2:	5.9	↓
3:	10.7x	↑
4:	10.7x	↘
5:	10.4x	↑
6:	7.7	↘
7:	9.9	←
8:	9.5	→
9:	8.9	↓
10:	9.8	←
<b>Serie</b>	<b>86.0</b>	
<b>Total</b>	<b>177.0</b>	

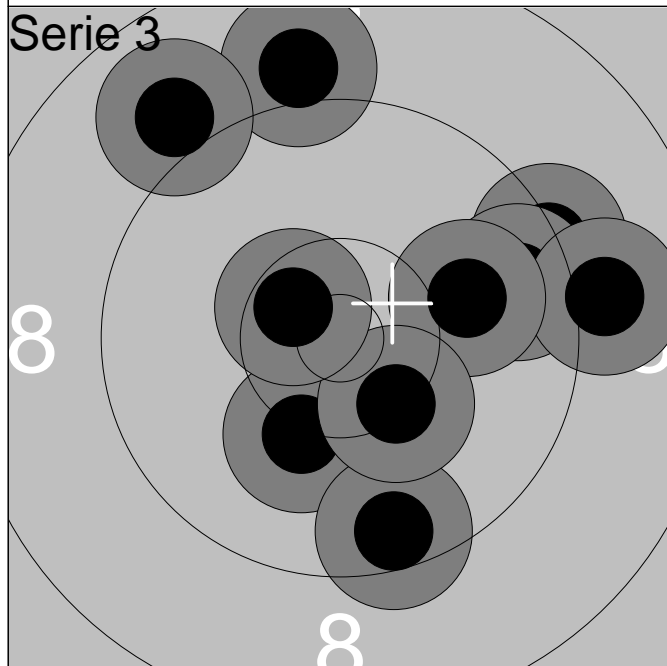

1:	9.3	↗
2:	9.6	→
3:	10.2	↘
4:	9.5	↘
5:	9.0	↗
6:	9.0	↗
7:	9.0	→
8:	10.0	→
9:	10.3	↘
10:	10.5x	↗
<b>Serie</b>	<b>94.0</b>	
<b>Total</b>	<b>271.0</b>	



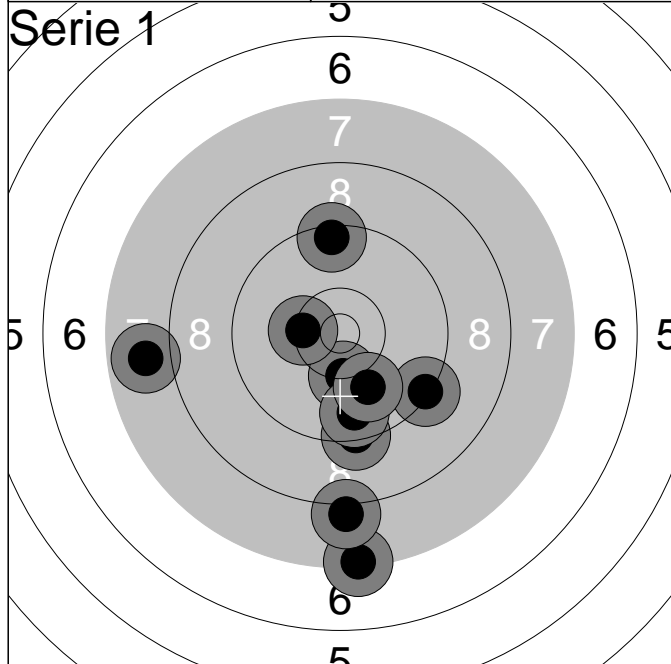

1:	9.3	↓
2:	7.3	↓
3:	10.3	↓
4:	7.8	←
5:	9.7	↓
6:	8.1	↓
7:	9.3	↘
8:	10.0	↓
9:	9.4	↑
10:	10.3	←
<b>Serie</b>		<b>88.0</b>
<b>Total</b>		<b>88.0</b>

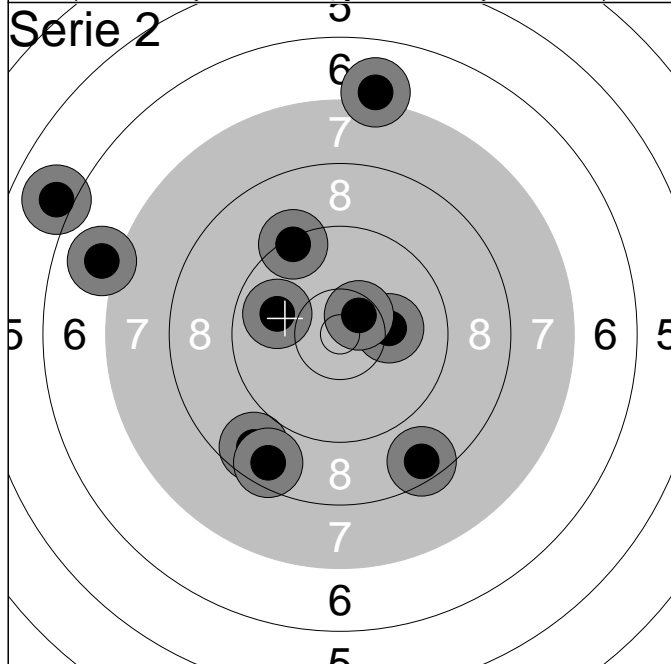

1:	7.0	←
2:	9.3	↑
3:	6.0	↗
4:	9.9	←
5:	8.5	↓
6:	8.7	↘
7:	10.2	→
8:	8.6	↘
9:	10.5x	↗
10:	7.0	↑
<b>Serie</b>		<b>82.0</b>
<b>Total</b>		<b>170.0</b>

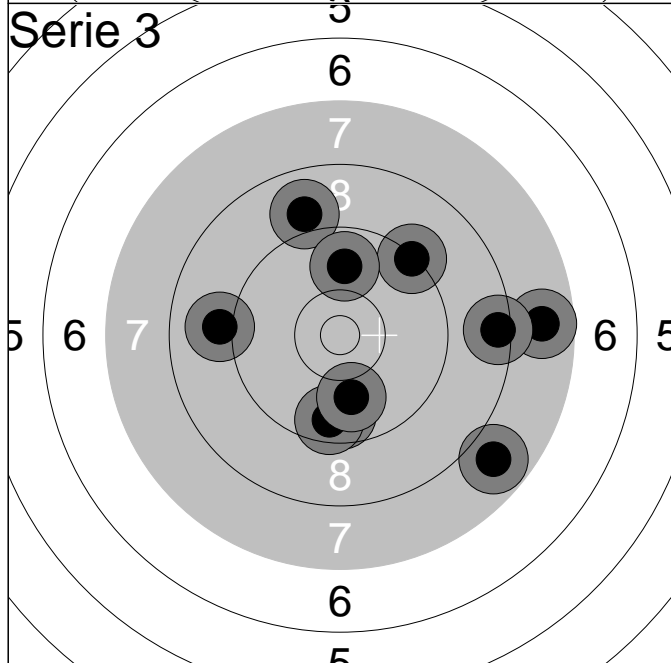

1:	9.3	↗
2:	7.8	↘
3:	8.9	↑
4:	9.0	←
5:	9.9	↑
6:	9.7	↓
7:	9.6	↓
8:	7.7	→
9:	9.9	↓
10:	8.4	→
<b>Serie</b>		<b>84.0</b>
<b>Total</b>		<b>254.0</b>

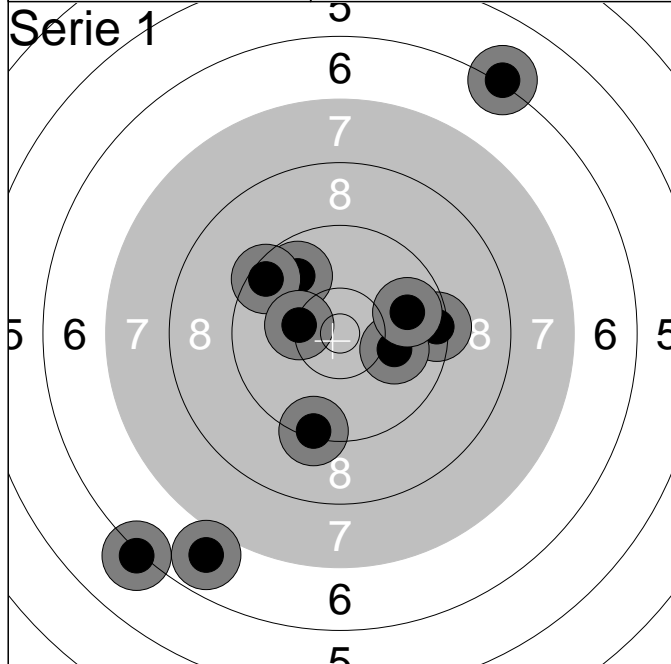

1:	9.4	→
2:	6.2	↗
3:	9.8	↗
4:	9.3	↓
5:	10.0	→
6:	9.8	→
7:	9.5	↗
8:	6.2	↙
9:	10.3	←
10:	6.8	↙
<b>Serie</b>		<b>83.0</b>
<b>Total</b>		<b>83.0</b>

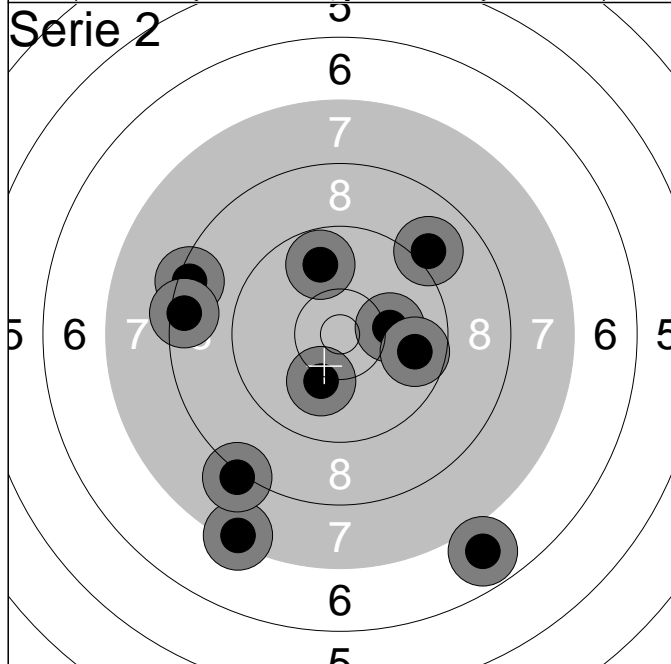

1:	9.8	↑
2:	8.4	←
3:	10.1	→
4:	10.1	↓
5:	7.4	↙
6:	6.8	↙
7:	9.0	↗
8:	8.4	←
9:	9.7	→
10:	8.1	↙
<b>Serie</b>		<b>84.0</b>
<b>Total</b>		<b>167.0</b>

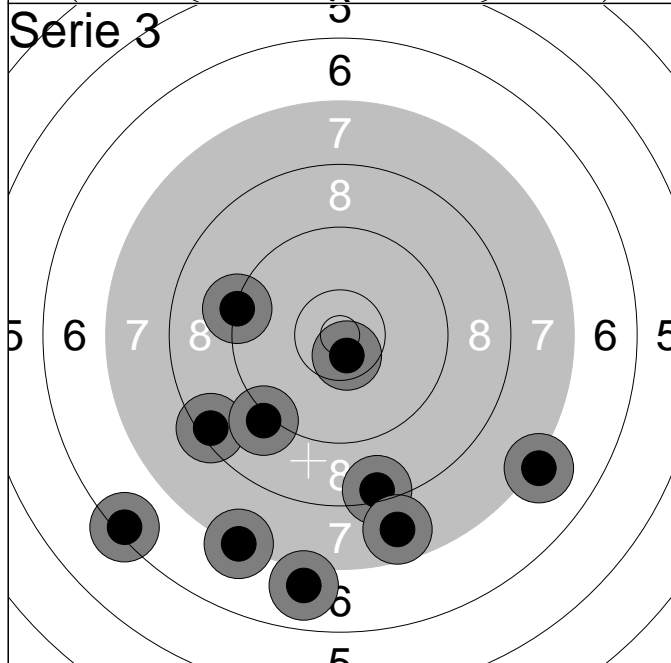

1:	6.9	↓
2:	7.3	↙
3:	10.6x	↓
4:	8.4	↙
5:	7.1	↘
6:	9.1	↙
7:	9.3	←
8:	8.4	↓
9:	6.4	↙
10:	7.7	↓
<b>Serie</b>		<b>77.0</b>
<b>Total</b>		<b>244.0</b>

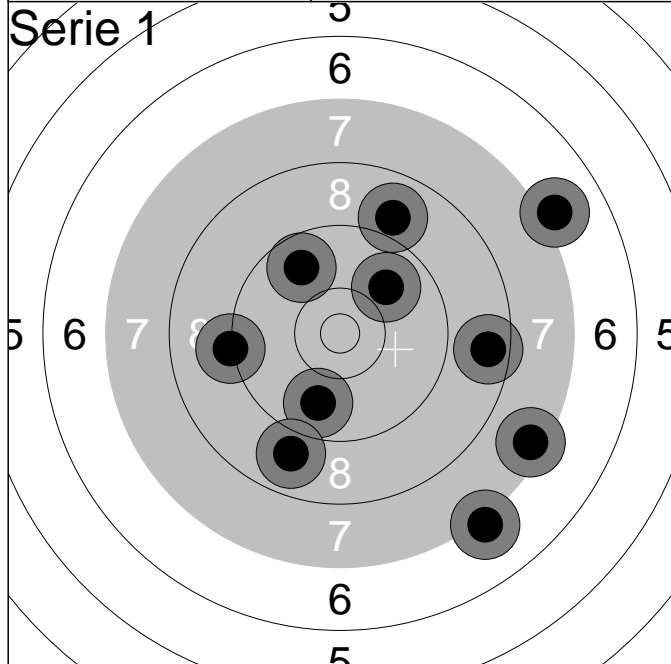

1:	7.0	↗
2:	9.7	↗
3:	7.1	↘
4:	7.5	↘
5:	8.6	→
6:	9.8	↘
7:	8.9	↗
8:	9.2	←
9:	9.9	↗
10:	8.9	↘

Serie	81.0
<b>Total</b>	<b>81.0</b>

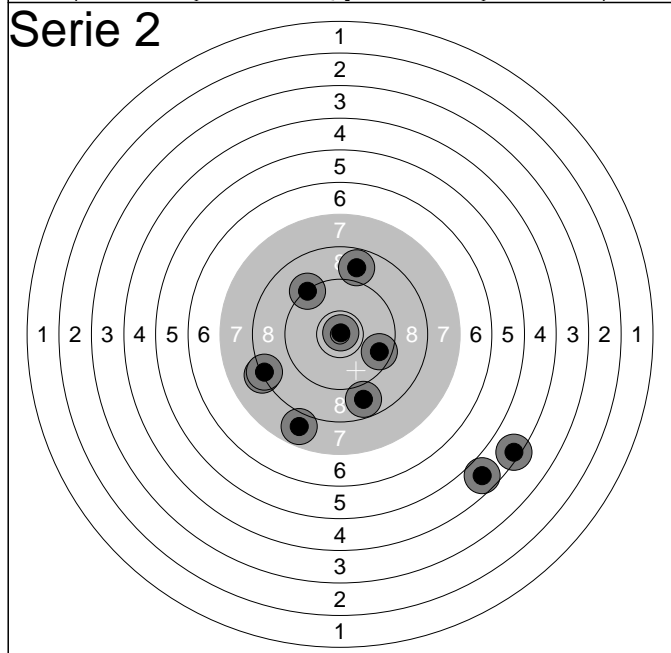

1:	10.9x	↗
2:	9.3	↗
3:	7.8	↘
4:	9.6	→
5:	8.8	↗
6:	8.8	↘
7:	4.4	↘
8:	8.2	←
9:	4.7	↘
10:	8.3	←

Serie	75.0
<b>Total</b>	<b>156.0</b>

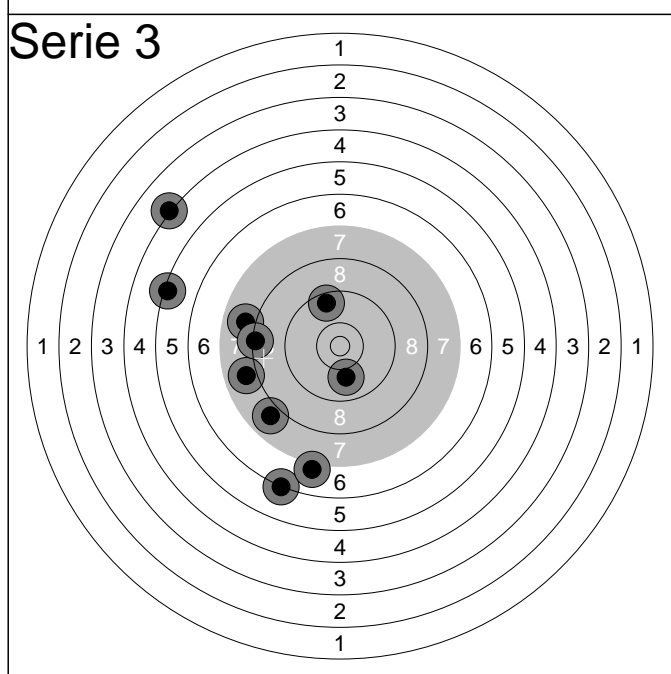

1:	6.2	↘
2:	5.3	←
3:	10.0	↘
4:	7.9	↘
5:	7.9	←
6:	4.2	↗
7:	7.9	←
8:	7.0	↘
9:	9.5	↗
10:	8.3	←

Serie	70.0
<b>Total</b>	<b>226.0</b>

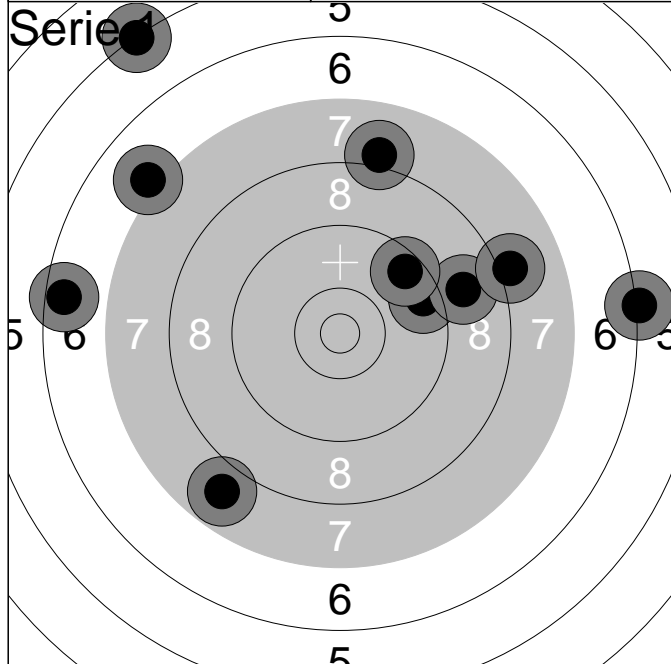

1:	7.0	↗
2:	7.8	↘
3:	5.2	↗
4:	9.5	→
5:	6.5	←
6:	8.9	→
7:	8.0	↑
8:	9.5	↗
9:	6.2	→
10:	8.1	→

Serie	<b>73.0</b>
Total	<b>73.0</b>

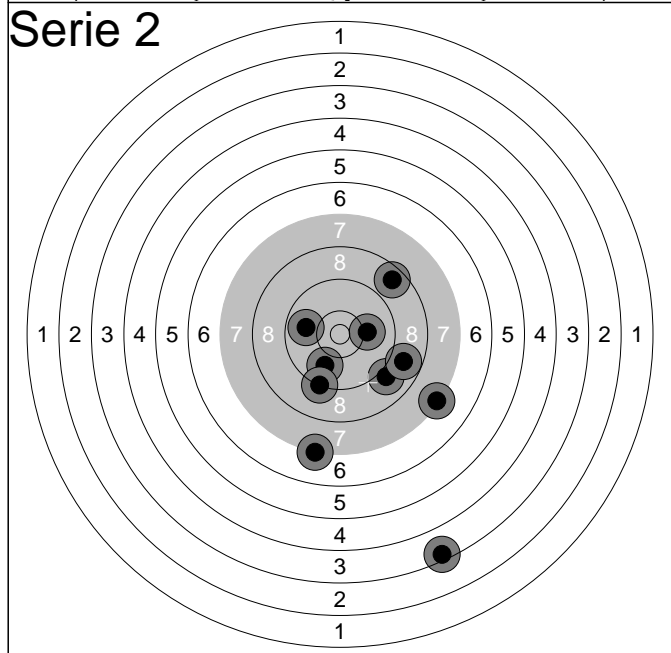

1:	9.9	←
2:	10.1	→
3:	8.6	↗
4:	7.3	↘
5:	9.0	↘
6:	8.8	↘
7:	9.9	↘
8:	3.4	↘
9:	7.2	↘
10:	9.2	↘

Serie	<b>79.0</b>
Total	<b>152.0</b>

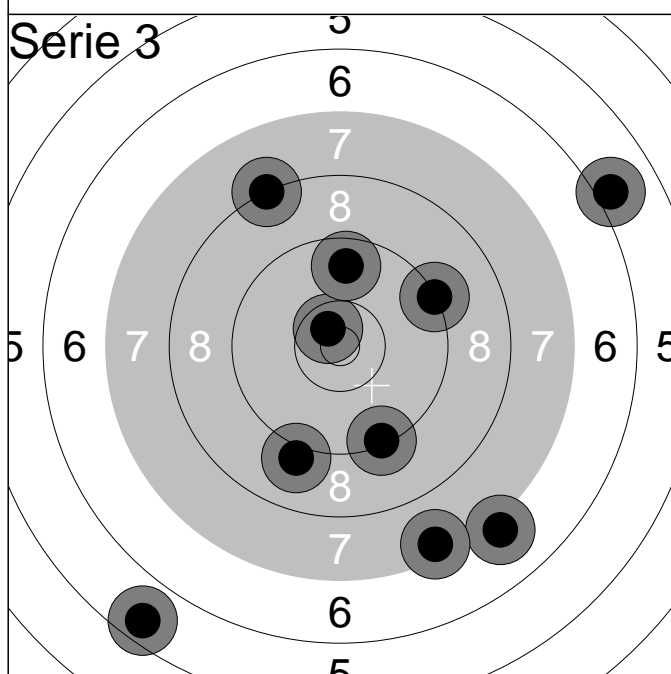

1:	9.0	↘
2:	7.1	↘
3:	10.6x	↗
4:	5.6	↘
5:	7.4	↘
6:	6.0	→
7:	9.7	↑
8:	9.3	↘
9:	8.2	↗
10:	9.3	→

Serie	<b>79.0</b>
Total	<b>231.0</b>

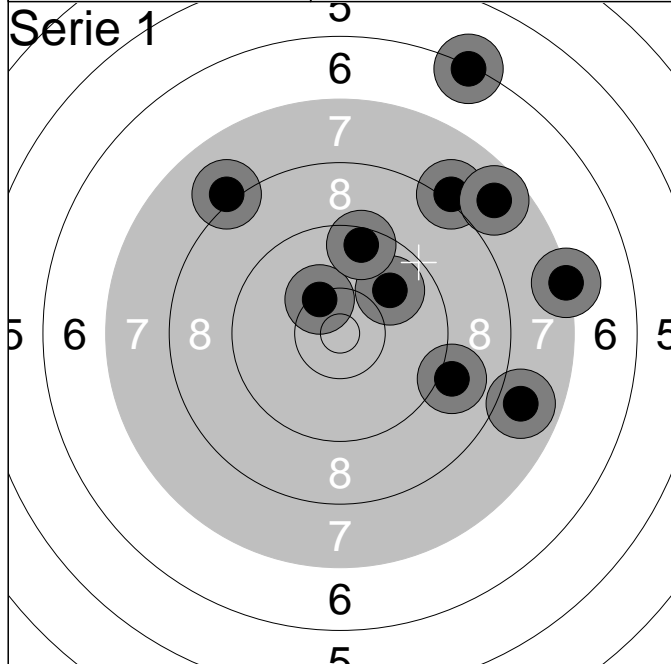

1:	7.9	→
2:	9.9	↗
3:	7.3	→
4:	8.1	↗
5:	10.3	↗
6:	8.1	↗
7:	9.0	→
8:	6.3	↗
9:	7.7	↗
10:	9.5	↑
<b>Serie</b>		<b>80.0</b>
<b>Total</b>		<b>80.0</b>

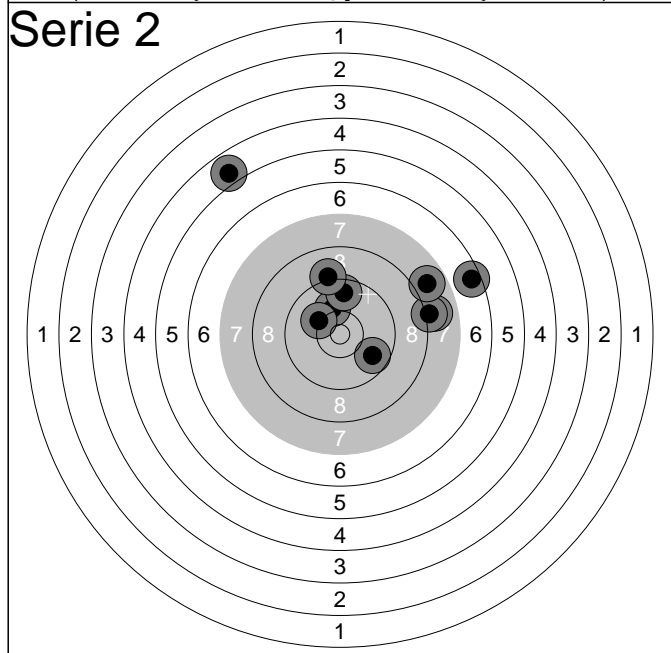

1:	4.9	↖
2:	10.1	↑
3:	7.9	→
4:	10.2	↖
5:	8.1	→
6:	9.7	↘
7:	9.6	↑
8:	7.8	↗
9:	6.5	→
10:	9.1	↑
<b>Serie</b>		<b>79.0</b>
<b>Total</b>		<b>159.0</b>

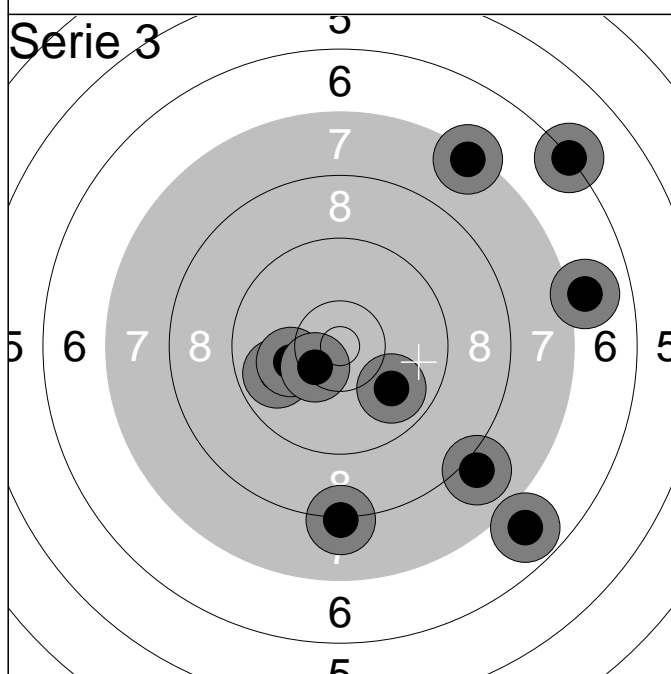

1:	9.8	←
2:	10.1	←
3:	8.0	↘
4:	7.0	→
5:	10.4x	↖
6:	7.4	↗
7:	9.9	↘
8:	8.2	↓
9:	6.8	↘
10:	6.2	↗
<b>Serie</b>		<b>80.0</b>
<b>Total</b>		<b>239.0</b>

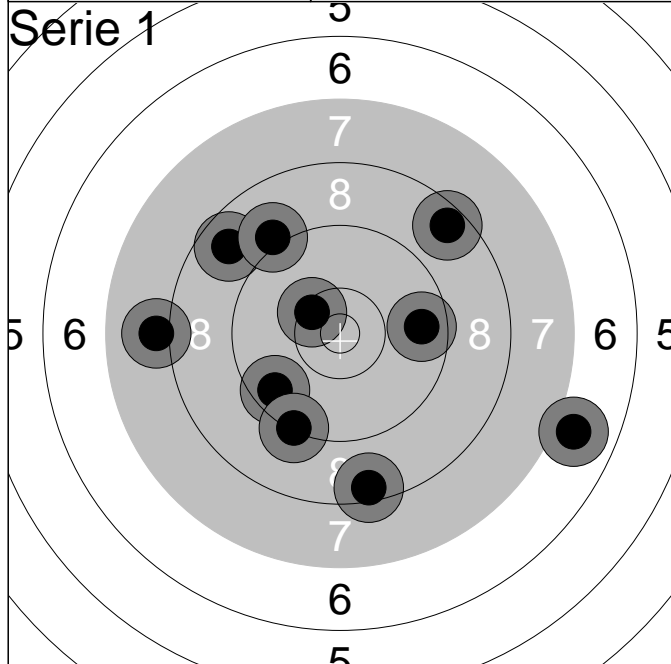

1:	9.6	→
2:	9.6	↙
3:	9.3	↘
4:	8.0	←
5:	8.5	↗
6:	8.7	↖
7:	10.4x	↗
8:	6.9	→
9:	8.4	↘
10:	9.1	↗
<b>Serie</b>		<b>84.0</b>
<b>Total</b>		<b>84.0</b>

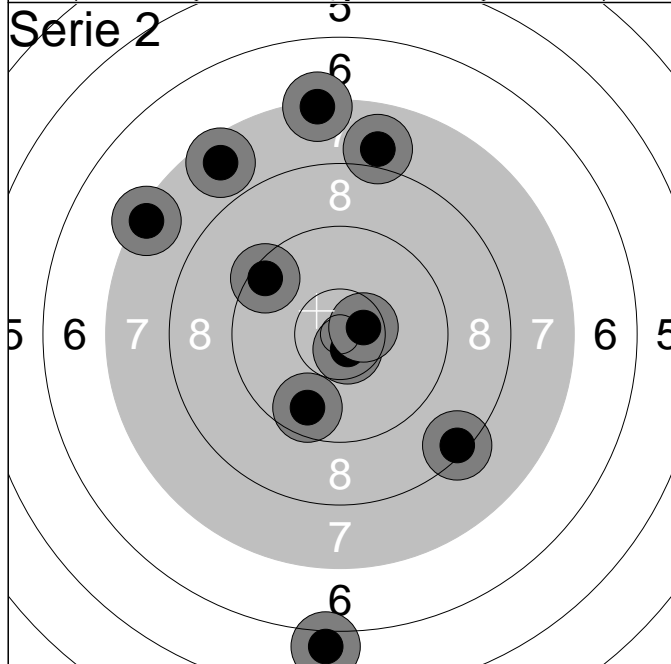

1:	7.6	↖
2:	10.7x	↘
3:	7.9	↗
4:	9.5	↖
5:	6.0	↘
6:	10.5x	→
7:	7.4	↖
8:	7.3	↗
9:	9.7	↘
10:	8.4	↘
<b>Serie</b>		<b>80.0</b>
<b>Total</b>		<b>164.0</b>

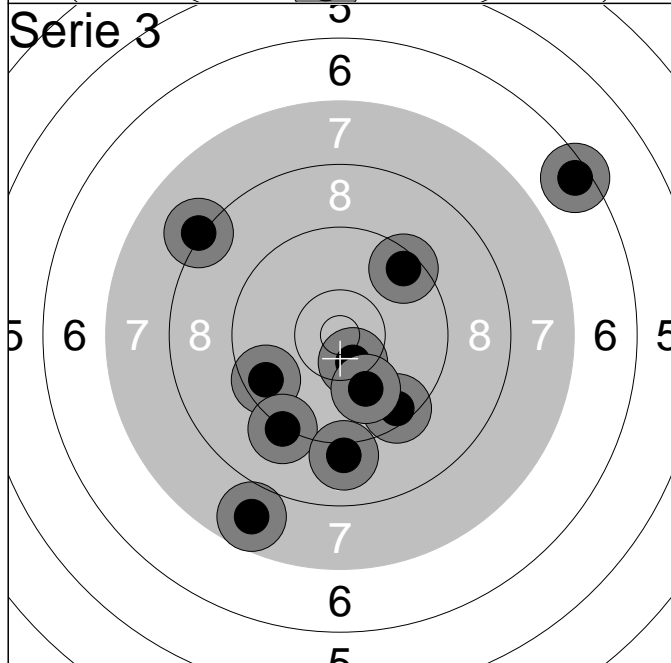

1:	9.6	↙
2:	9.5	↘
3:	10.5x	↘
4:	9.5	↗
5:	10.0	↘
6:	6.4	↗
7:	9.2	↙
8:	8.2	↖
9:	9.0	↘
10:	7.7	↙
<b>Serie</b>		<b>86.0</b>
<b>Total</b>		<b>250.0</b>

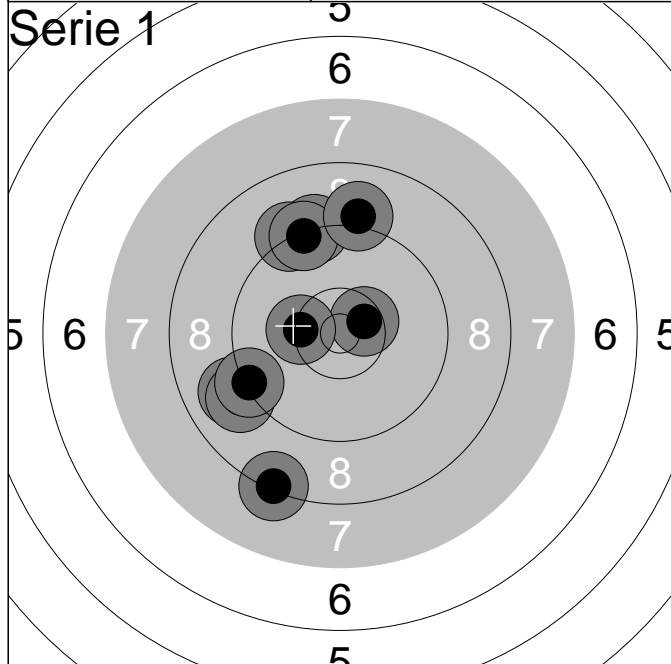

1:	9.0	←
2:	9.2	↑
3:	8.3	↓
4:	9.1	←
5:	9.3	←
6:	9.2	↑
7:	10.5x	↗
8:	10.3	←
9:	9.3	↑
10:	9.1	↑
<b>Serie</b>		<b>91.0</b>
<b>Total</b>		<b>91.0</b>

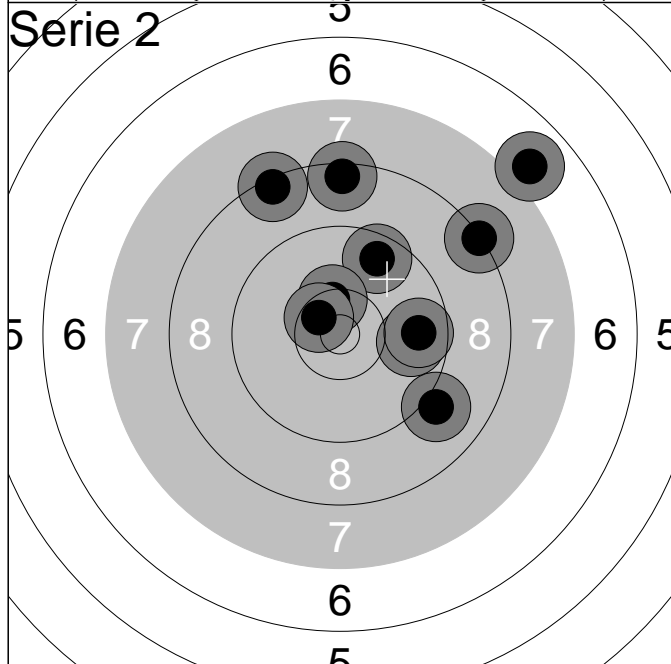

1:	9.8	→
2:	9.6	↑
3:	9.0	↓
4:	8.4	↑
5:	8.3	↗
6:	10.4x	↑
7:	10.5x	↗
8:	6.9	↗
9:	8.4	↑
10:	9.7	→
<b>Serie</b>		<b>86.0</b>
<b>Total</b>		<b>177.0</b>

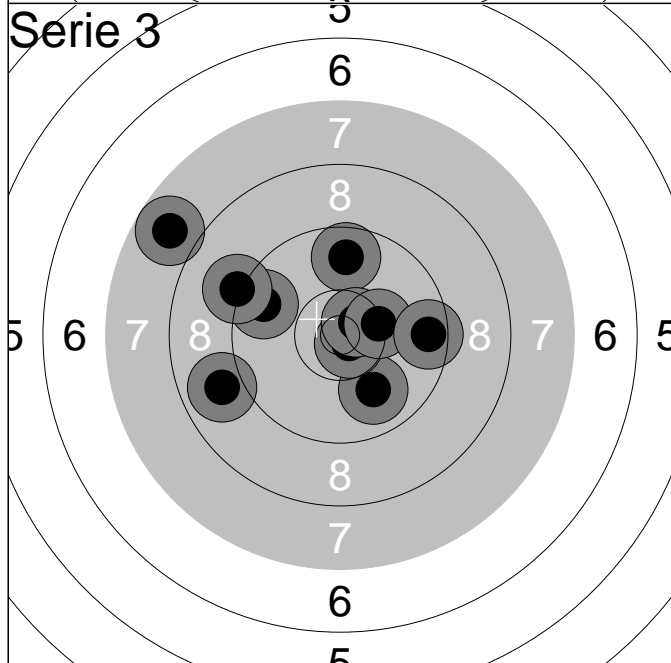

1:	8.9	←
2:	9.9	↓
3:	10.7x	↓
4:	7.8	↗
5:	9.7	↑
6:	9.6	←
7:	10.6x	↗
8:	9.2	←
9:	10.3	→
10:	9.5	→
<b>Serie</b>		<b>90.0</b>
<b>Total</b>		<b>267.0</b>

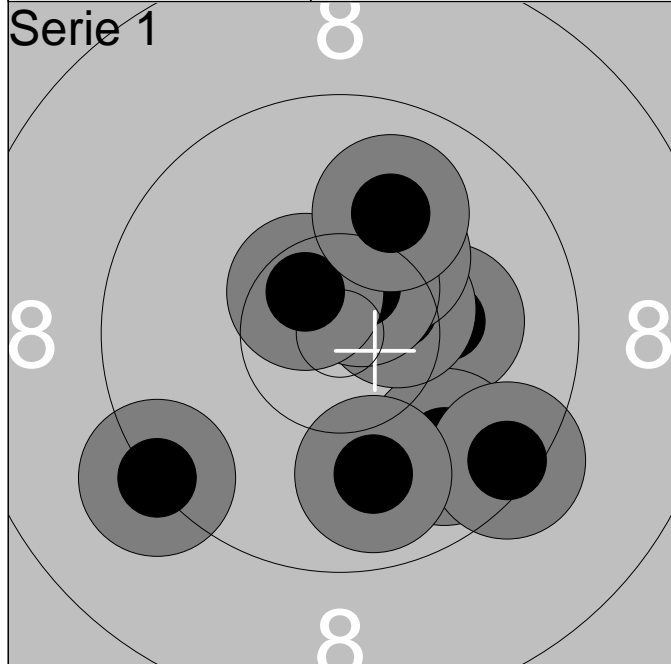

1:	10.2	→
2:	9.8	↓
3:	9.3	↙
4:	9.4	↓
5:	10.5x	→
6:	9.9	↓
7:	10.3	↗
8:	10.6x	↗
9:	10.6x	↗
10:	10.0	↗
<b>Serie</b>		<b>96.0</b>
<b>Total</b>		<b>96.0</b>

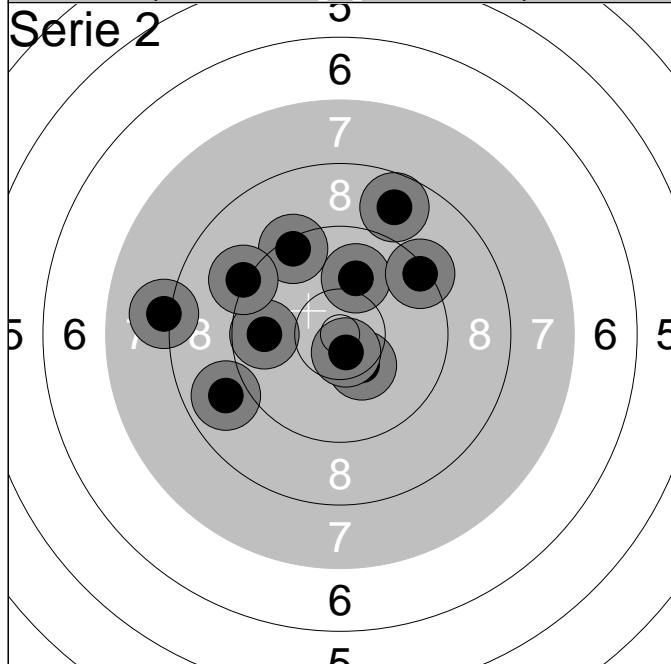

1:	9.7	←
2:	10.3	↓
3:	10.0	↗
4:	9.4	↗
5:	8.1	←
6:	9.3	↗
7:	10.6x	↓
8:	8.9	↙
9:	8.7	↗
10:	9.2	↙
<b>Serie</b>		<b>90.0</b>
<b>Total</b>		<b>186.0</b>

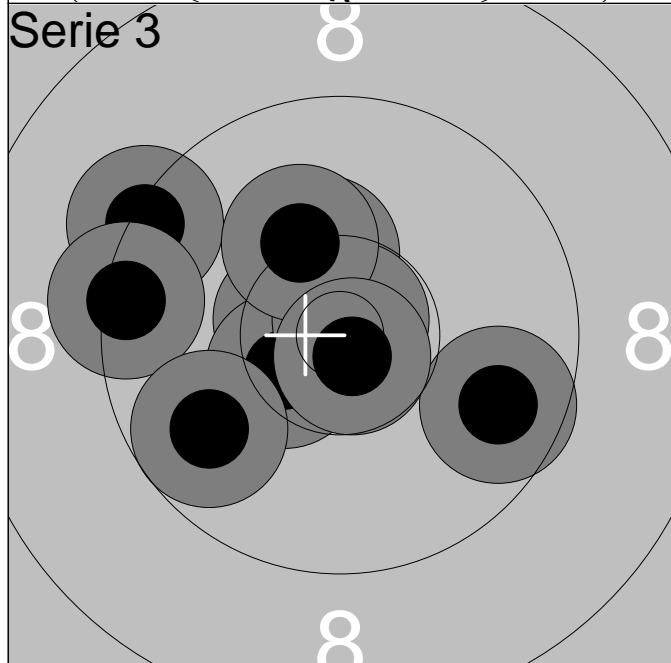

1:	10.3	↗
2:	9.3	↗
3:	10.6x	↙
4:	10.5x	↙
5:	9.4	←
6:	10.8x	↗
7:	10.2	↗
8:	9.8	↙
9:	9.7	→
10:	10.8x	↓
<b>Serie</b>		<b>96.0</b>
<b>Total</b>		<b>282.0</b>



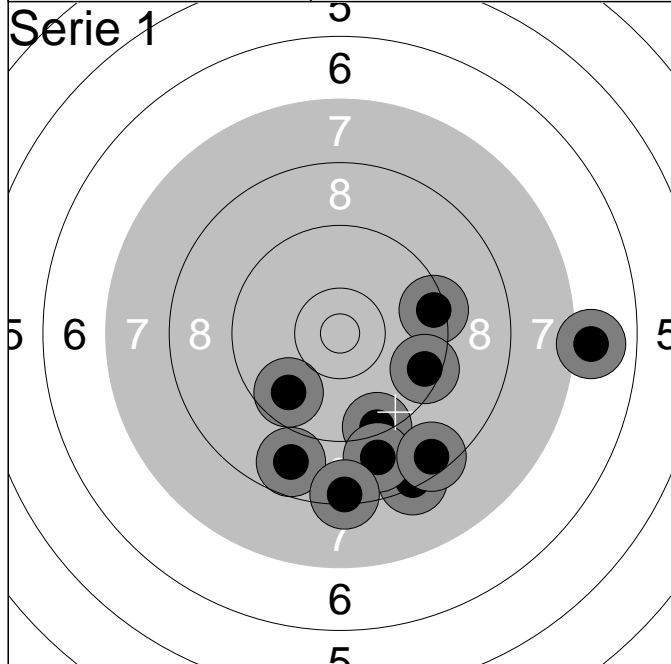

1:	8.8	↙
2:	8.3	↙
3:	9.4	→
4:	9.7	↙
5:	9.3	↙
6:	8.9	↙
7:	8.4	↙
8:	9.5	→
9:	8.5	↙
10:	6.9	→
<b>Serie</b>		<b>82.0</b>
<b>Total</b>		<b>82.0</b>

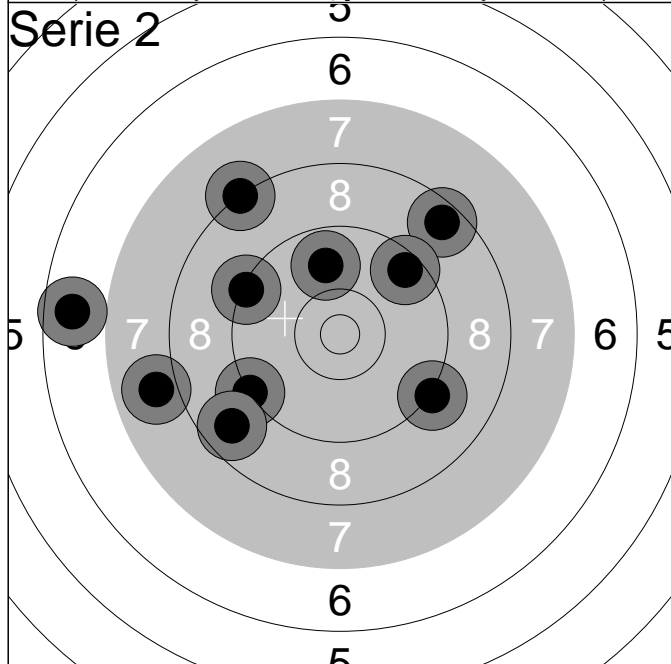

1:	9.2	↙
2:	8.7	↙
3:	8.2	↗
4:	9.3	↗
5:	8.5	↗
6:	9.5	↗
7:	9.8	↗
8:	7.9	↙
9:	6.7	↙
10:	9.2	↘
<b>Serie</b>		<b>82.0</b>
<b>Total</b>		<b>164.0</b>

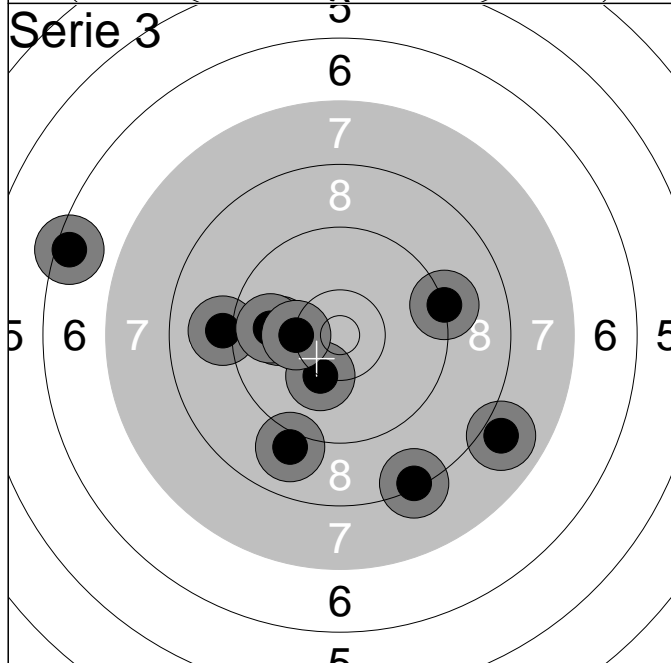

1:	9.1	↙
2:	10.0	↙
3:	9.0	↙
4:	7.9	↘
5:	10.2	↙
6:	8.3	↙
7:	6.4	↙
8:	9.2	→
9:	9.8	↙
10:	10.2	↙
<b>Serie</b>		<b>87.0</b>
<b>Total</b>		<b>251.0</b>

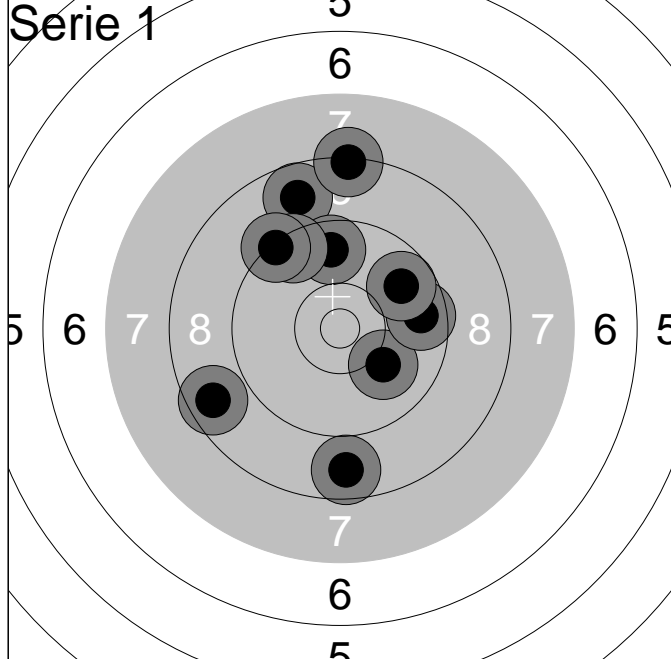

1:	8.6	↙
2:	8.7	↓
3:	8.8	↑
4:	10.0	↘
5:	9.7	↑
6:	8.3	↑
7:	9.5	↗
8:	9.6	→
9:	9.3	↗
10:	9.8	↗
<b>Serie</b>		<b>87.0</b>
<b>Total</b>		<b>87.0</b>

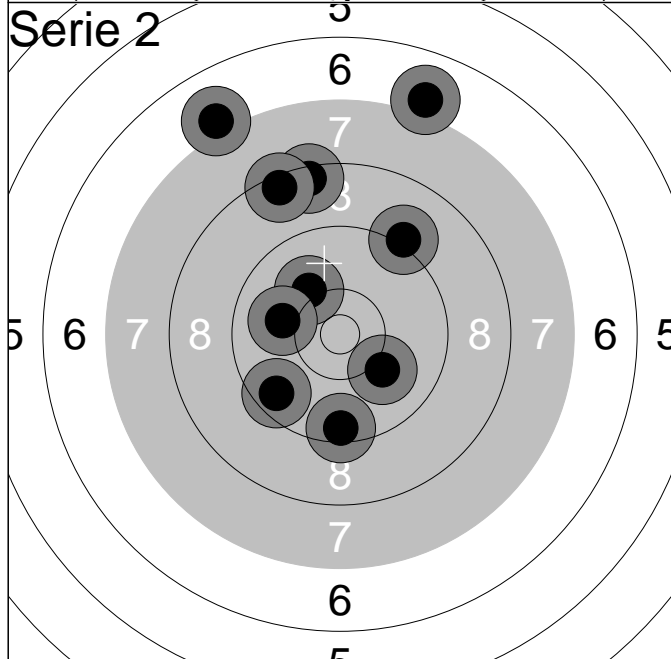

1:	9.5	↓
2:	10.1	↘
3:	8.4	↑
4:	9.6	↙
5:	7.0	↑
6:	10.1	↗
7:	7.0	↑
8:	9.1	↗
9:	10.0	↙
10:	8.4	↑
<b>Serie</b>		<b>87.0</b>
<b>Total</b>		<b>174.0</b>

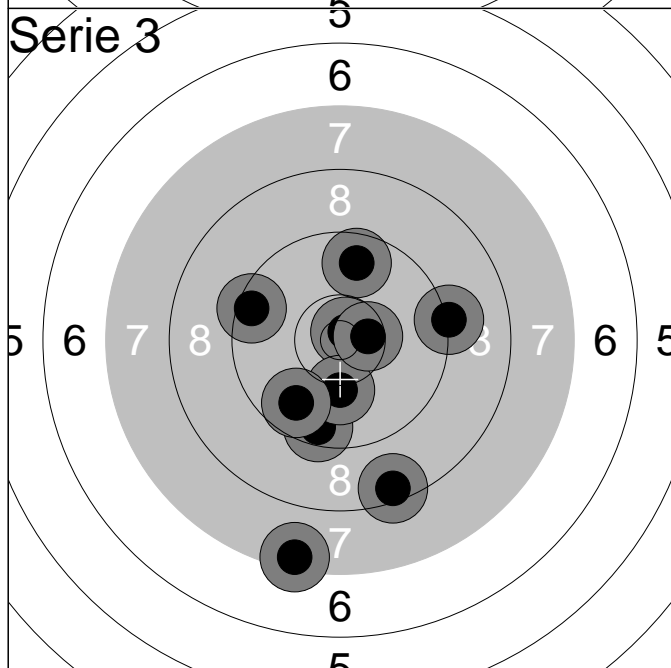

1:	10.8x	↗
2:	9.5	↓
3:	9.7	↑
4:	10.2	↓
5:	10.5x	→
6:	7.4	↓
7:	9.2	→
8:	9.5	↙
9:	9.7	↙
10:	8.4	↓
<b>Serie</b>		<b>90.0</b>
<b>Total</b>		<b>264.0</b>

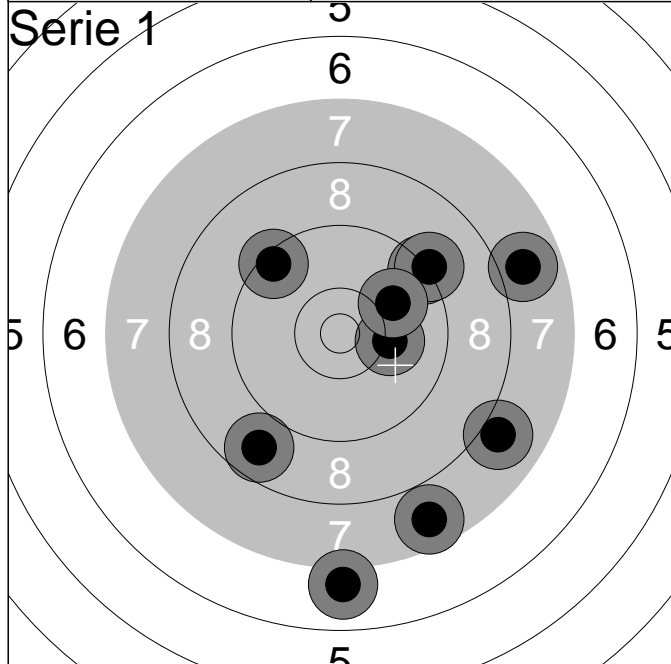

1:	8.0	↘
2:	10.1	→
3:	7.7	↙
4:	8.7	↙
5:	9.3	↗
6:	9.2	↗
7:	10.0	↗
8:	7.0	↓
9:	9.4	↖
10:	7.8	→
<b>Serie</b>		<b>84.0</b>
<b>Total</b>		<b>84.0</b>

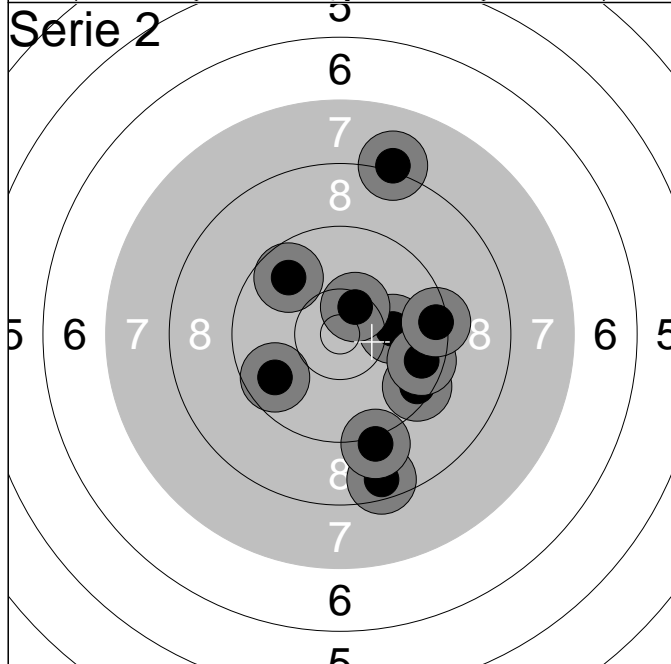

1:	8.5	↙
2:	9.5	↙
3:	10.1	→
4:	9.6	→
5:	10.4x	↗
6:	9.4	→
7:	9.7	↗
8:	9.1	↓
9:	9.7	↖
10:	8.1	↗
<b>Serie</b>		<b>90.0</b>
<b>Total</b>		<b>174.0</b>

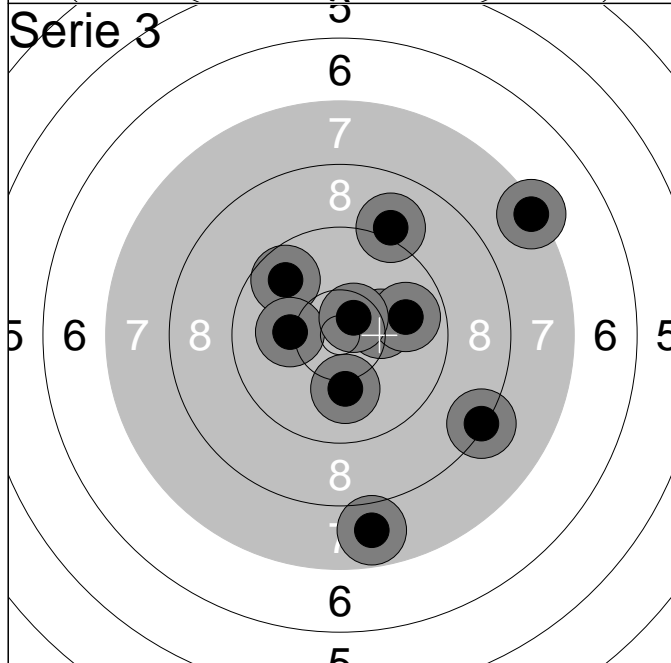

1:	9.1	↗
2:	10.3	→
3:	9.9	→
4:	9.7	↗
5:	10.2	←
6:	10.6x	↗
7:	7.8	↓
8:	10.1	↓
9:	7.3	↗
10:	8.3	↘
<b>Serie</b>		<b>89.0</b>
<b>Total</b>		<b>263.0</b>

Lag	Skive	Philip Adielson	
4	1		

Luft	Vestre Bærum Salongskytterl.	R14	
------	------------------------------	-----	--

16.04.2015	Landsstevnet rekrutt 2015	LS Rekrutt 2015	
------------	---------------------------	-----------------	--

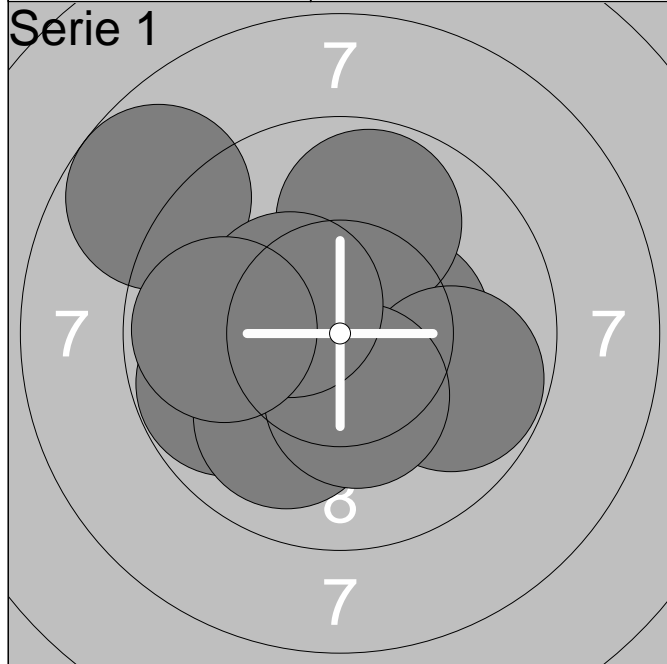

1:	10.4x	→
2:	10.4x	↓
3:	9.8	←
4:	9.8	↑
5:	9.8	→
6:	10.0	↙
7:	8.7	↗
8:	10.3x	↓
9:	10.4x	↗
10:	9.8	←
<b>Serie</b>		<b>94.0</b>
<b>Total</b>		<b>94.0</b>

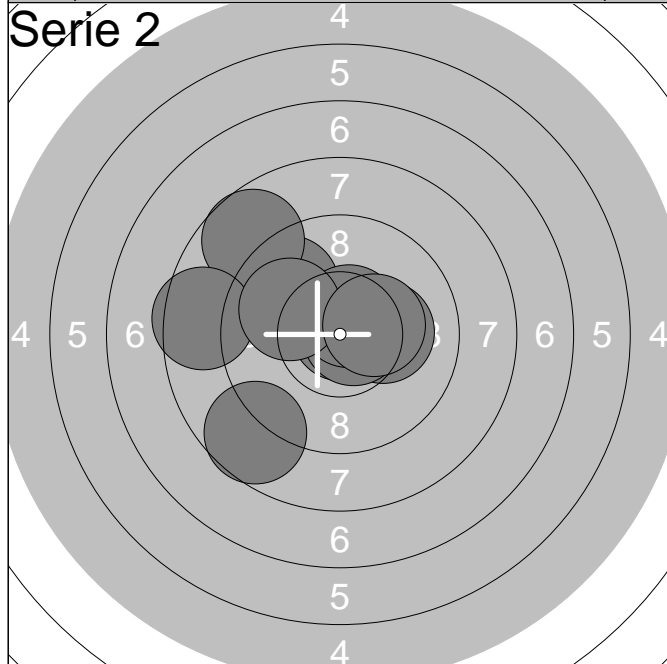

1:	8.6	↙
2:	9.7	↗
3:	8.7	↗
4:	8.5	←
5:	10.2x	→
6:	10.8x	↗
7:	10.7x	→
8:	10.6x	↗
9:	10.0	↗
10:	10.3x	→
<b>Serie</b>		<b>93.0</b>
<b>Total</b>		<b>187.0</b>

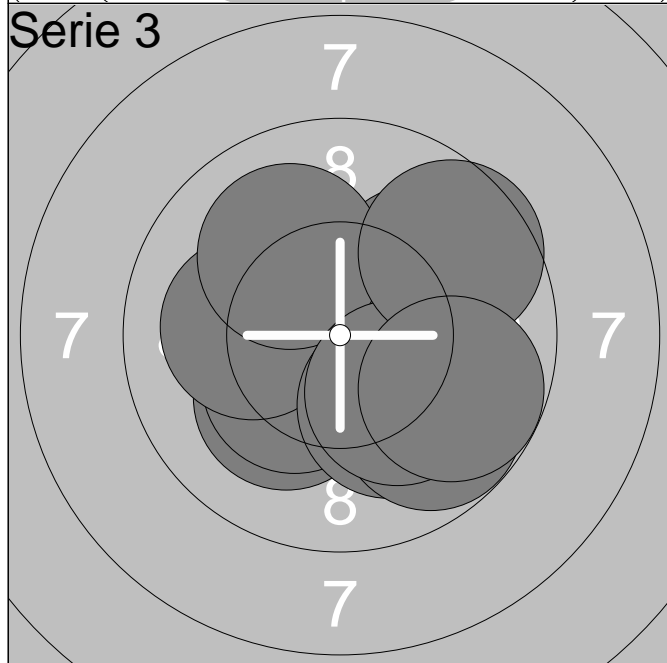

1:	10.1	↙
2:	10.3x	↙
3:	10.1	←
4:	10.1	↓
5:	10.0	↗
6:	9.7	↓
7:	10.0	↗
8:	10.1	↓
9:	9.6	↗
10:	9.7	↘
<b>Serie</b>		<b>97.0</b>
<b>Total</b>		<b>284.0</b>

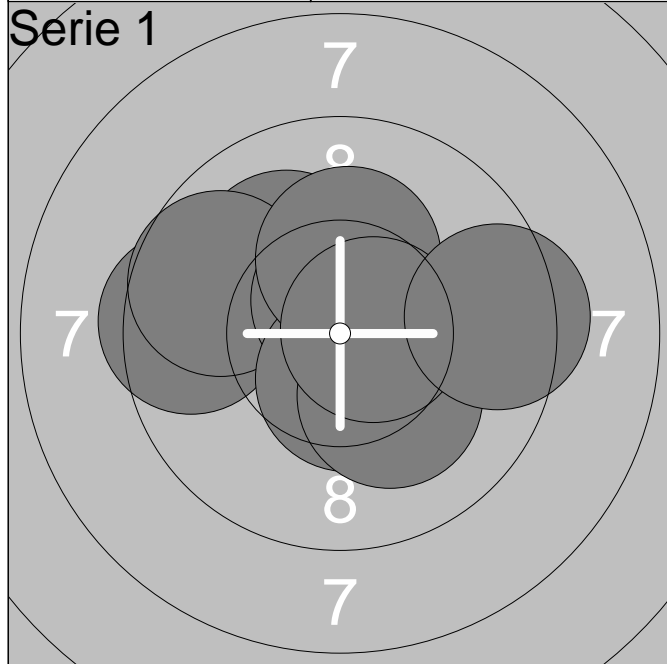

1:	9.5	←
2:	10.1	↗
3:	10.6x	→
4:	9.7	↖
5:	10.6x	↑
6:	10.5x	↓
7:	10.1	↘
8:	10.2x	↑
9:	10.6x	→
10:	9.4	→
<b>Serie</b>		<b>97.0</b>
<b>Total</b>		<b>97.0</b>

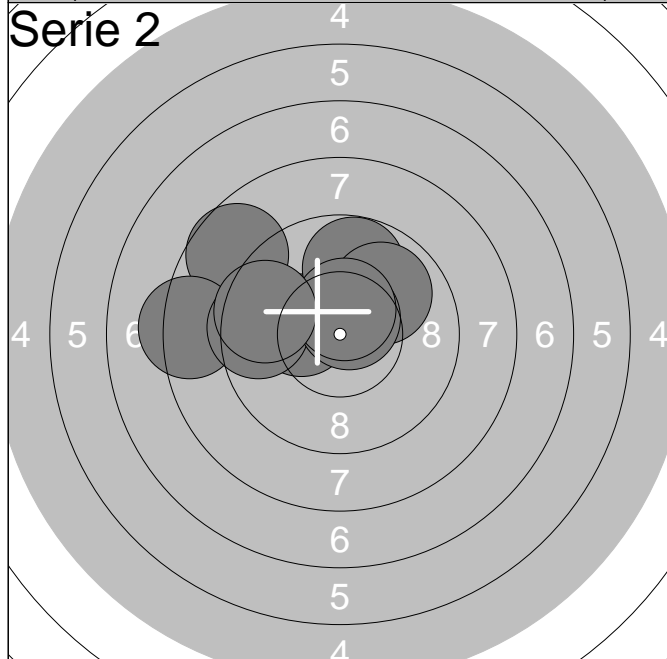

1:	10.0	↗
2:	10.3x	←
3:	8.7	↖
4:	9.8	↑
5:	8.3	←
6:	9.9	↗
7:	9.5	←
8:	10.6x	↗
9:	10.5x	↑
10:	9.5	←
<b>Serie</b>		<b>92.0</b>
<b>Total</b>		<b>189.0</b>



1:	9.6	→
2:	10.1	↗
3:	10.4x	↑
4:	9.8	↘
5:	8.8	↑
6:	10.6x	↗
7:	9.7	↑
8:	5.4	↘
9:	10.1	→
10:	9.8	→
<b>Serie</b>		<b>89.0</b>
<b>Total</b>		<b>278.0</b>

Lag <b>4</b>	Skive <b>4</b>	<b>Sigmund Grimsrud</b>	
-----------------	-------------------	-------------------------	--

Luft	Krapfoss Sportskytterlag	R14	
------	--------------------------	-----	--

16.04.2015	Landsstevnet rekrutt 2015	LS Rekrutt 2015	
------------	---------------------------	-----------------	--

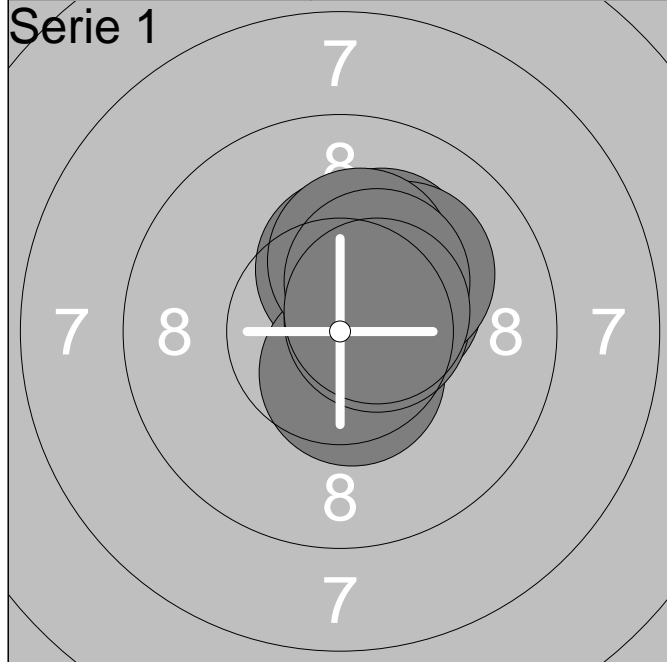

1:	10.3x	↑
2:	10.2x	↗
3:	10.4x	↗
4:	10.5x	↓
5:	10.3x	↗
6:	10.5x	→
7:	10.1	↗
8:	10.2x	↑
9:	10.3x	↗
10:	10.5x	↗
<b>Serie</b>		<b>100.0</b>
<b>Total</b>		<b>100.0</b>

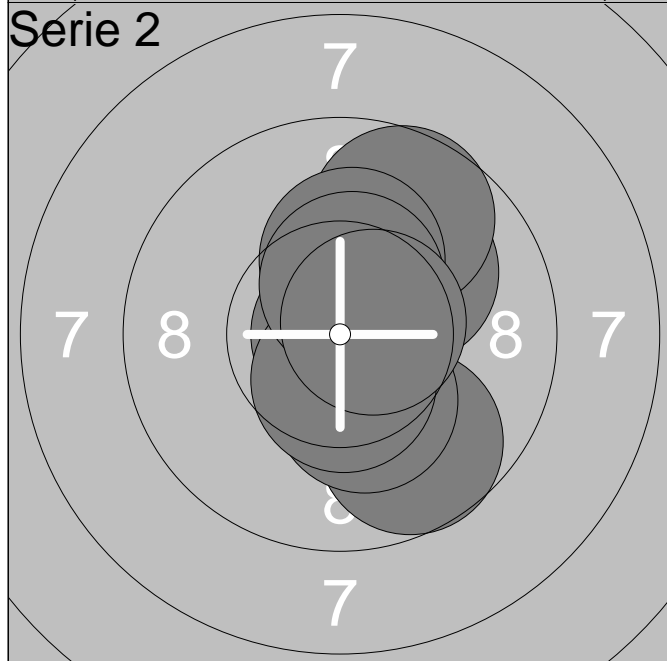

1:	9.7	↓
2:	10.3x	↓
3:	10.7x	→
4:	10.1	↗
5:	10.9x	→
6:	10.5x	↓
7:	9.7	↗
8:	10.2x	↑
9:	10.4x	↑
10:	10.6x	→
<b>Serie</b>		<b>98.0</b>
<b>Total</b>		<b>198.0</b>



1:	10.6x	→
2:	10.4x	↗
3:	10.0	↗
4:	10.0	→
5:	10.7x	↗
6:	10.0	↗
7:	10.3x	↗
8:	10.2x	←
9:	10.6x	→
10:	10.5x	↑
<b>Serie</b>		<b>100.0</b>
<b>Total</b>		<b>298.0</b>

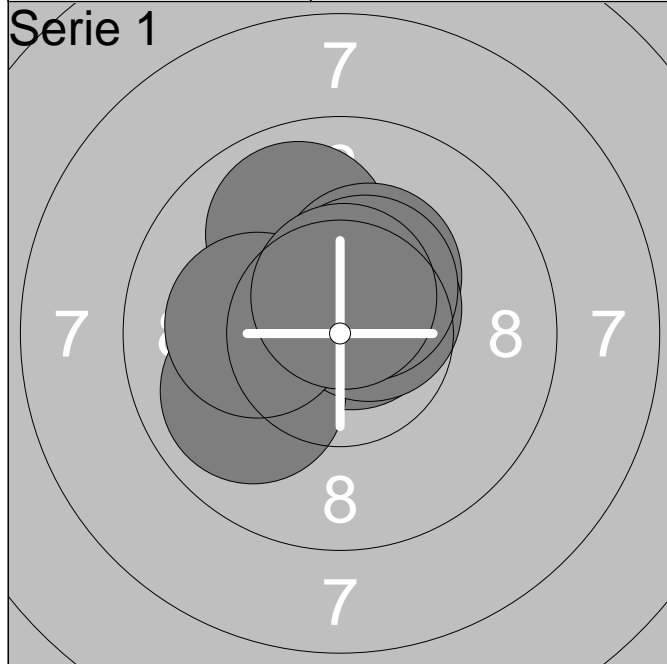

1:	10.5x	↑
2:	9.9	↖
3:	10.8x	↑
4:	10.7x	↗
5:	10.3x	↗
6:	9.9	↖
7:	10.6x	↗
8:	10.1	←
9:	10.4x	↗
10:	10.6x	↑

Serie	98.0
Total	98.0

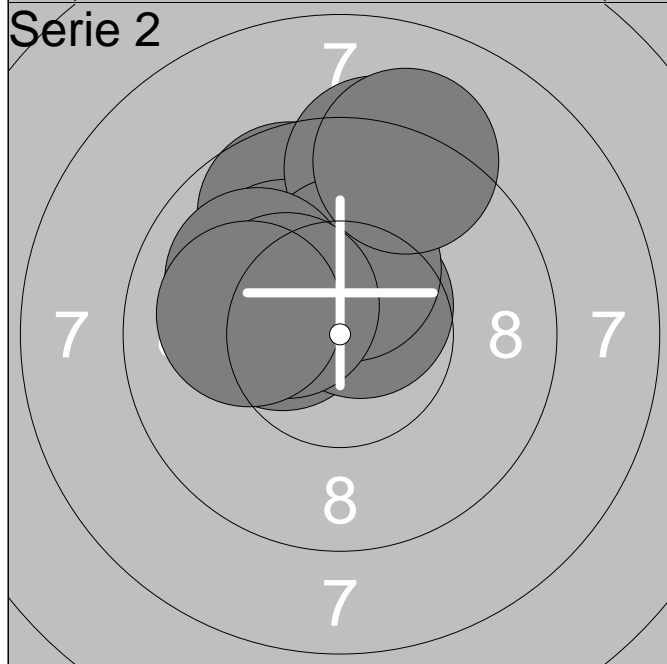

1:	9.7	↖
2:	10.1	↖
3:	10.3x	↖
4:	10.6x	↗
5:	9.3	↑
6:	10.3x	↑
7:	10.0	↖
8:	10.4x	↖
9:	10.0	←
10:	9.1	↗

Serie	97.0
Total	195.0

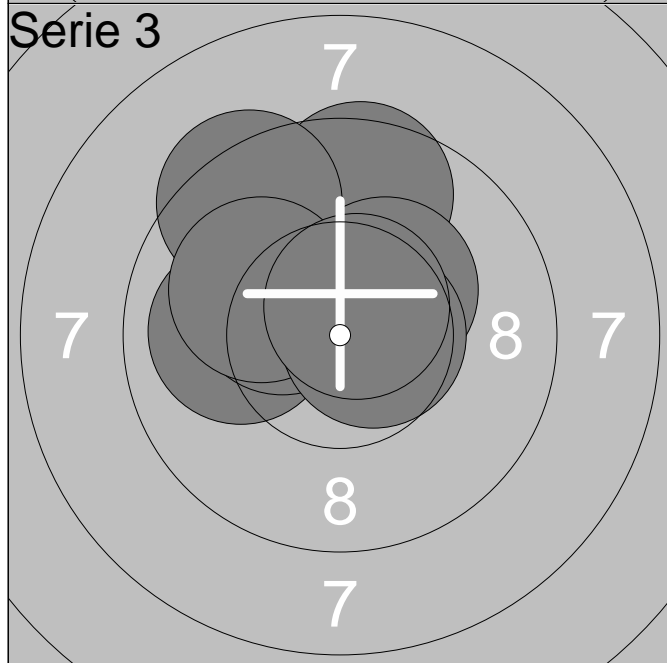

1:	9.6	↑
2:	10.0	←
3:	10.2x	↖
4:	10.5x	↗
5:	10.3x	↗
6:	10.3x	↖
7:	9.4	↗
8:	10.0	↖
9:	10.6x	→
10:	10.6x	↗

Serie	98.0
Total	293.0

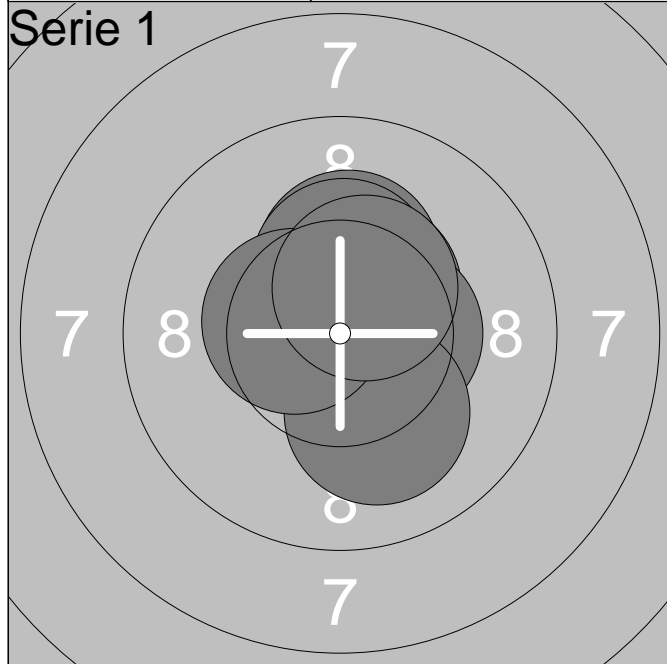

1:	10.7x	↗
2:	10.2x	↑
3:	10.6x	↑
4:	10.4x	↗
5:	10.6x	→
6:	10.4x	→
7:	10.3x	↑
8:	10.1	↓
9:	10.5x	←
10:	10.4x	↗
<b>Serie</b>		<b>100.0</b>
<b>Total</b>		<b>100.0</b>

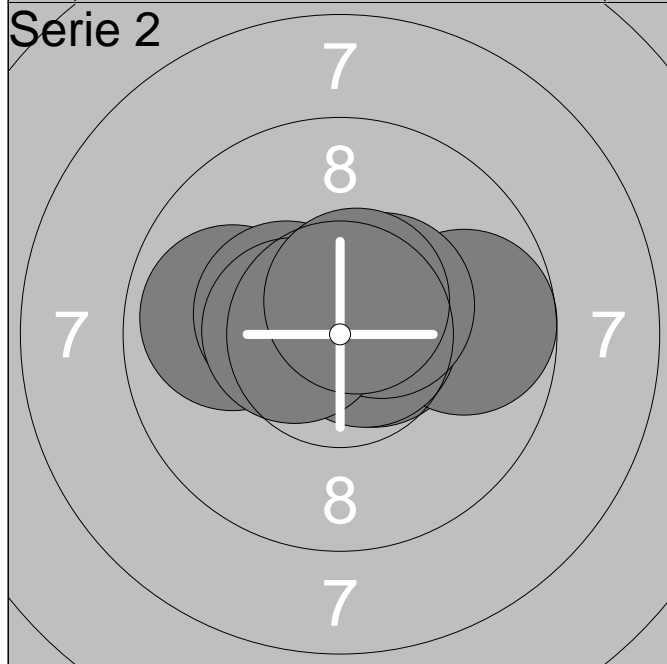

1:	10.6x	→
2:	10.6x	→
3:	9.7	→
4:	10.7x	→
5:	10.5x	←
6:	10.4x	↗
7:	9.9	←
8:	10.4x	←
9:	10.5x	←
10:	10.6x	↗
<b>Serie</b>		<b>98.0</b>
<b>Total</b>		<b>198.0</b>

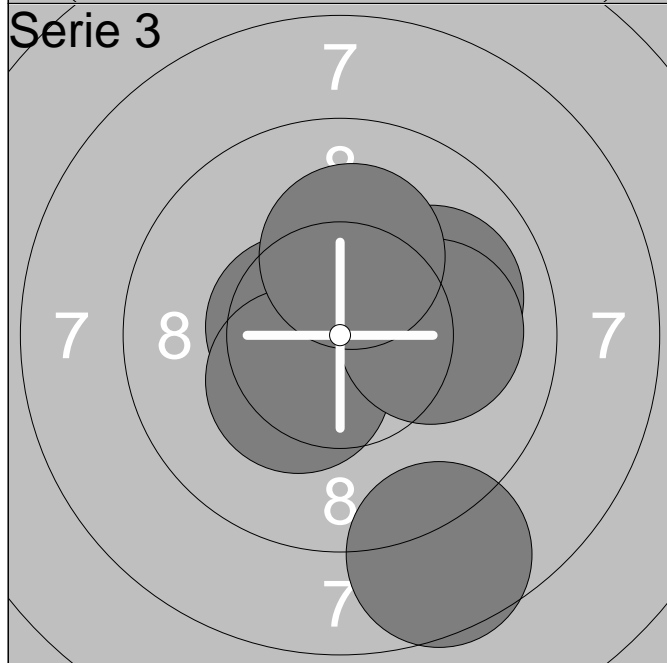

1:	10.0	→
2:	10.5x	↑
3:	10.7x	↑
4:	10.5x	↗
5:	8.6	↓
6:	10.7x	↑
7:	10.5x	←
8:	10.3x	↙
9:	10.0	→
10:	10.2x	↑
<b>Serie</b>		<b>98.0</b>
<b>Total</b>		<b>296.0</b>



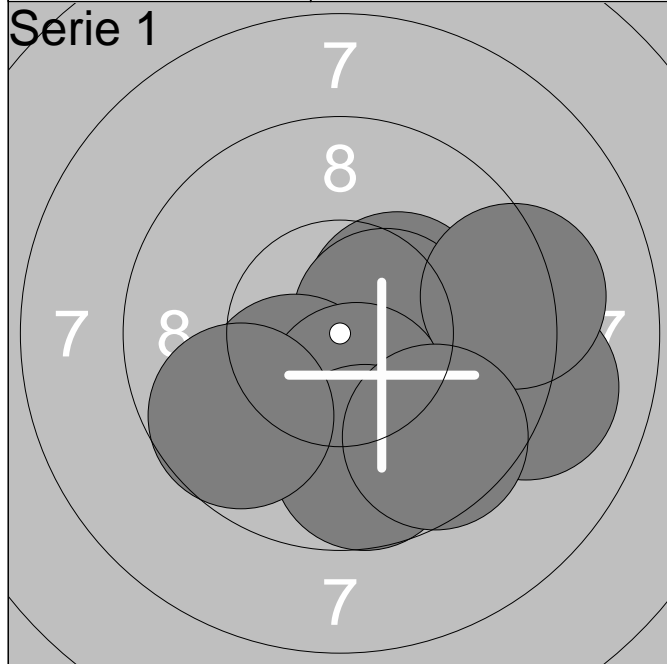

1:	10.3x	↗
2:	9.1	→
3:	10.5x	→
4:	10.2x	↓
5:	10.2x	↙
6:	10.3x	↓
7:	9.7	↓
8:	9.2	→
9:	9.6	↓
10:	9.7	↙
<b>Serie</b>		<b>95.0</b>
<b>Total</b>		<b>95.0</b>

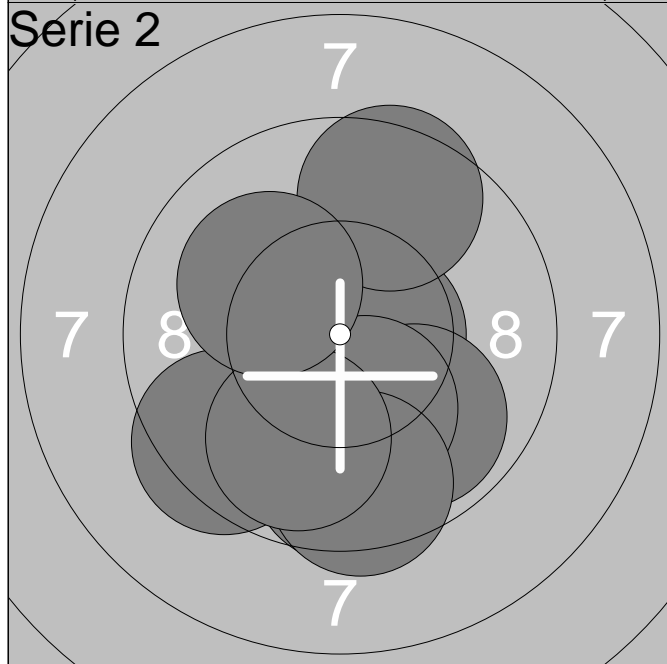

1:	10.3x	↙
2:	10.6x	→
3:	9.9	↓
4:	9.6	↓
5:	10.2x	↓
6:	9.5	↓
7:	9.5	↑
8:	9.4	↙
9:	9.9	↓
10:	10.1	↖
<b>Serie</b>		<b>94.0</b>
<b>Total</b>		<b>189.0</b>

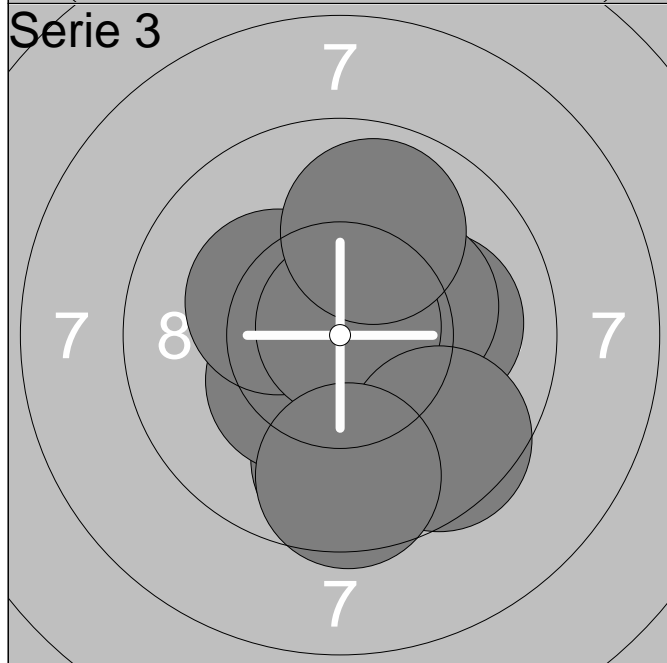

1:	10.4x	↗
2:	9.7	↓
3:	10.3x	↙
4:	10.1	→
5:	10.2x	↗
6:	10.2x	↖
7:	10.8x	↗
8:	9.5	↓
9:	9.6	↓
10:	9.9	↑
<b>Serie</b>		<b>96.0</b>
<b>Total</b>		<b>285.0</b>

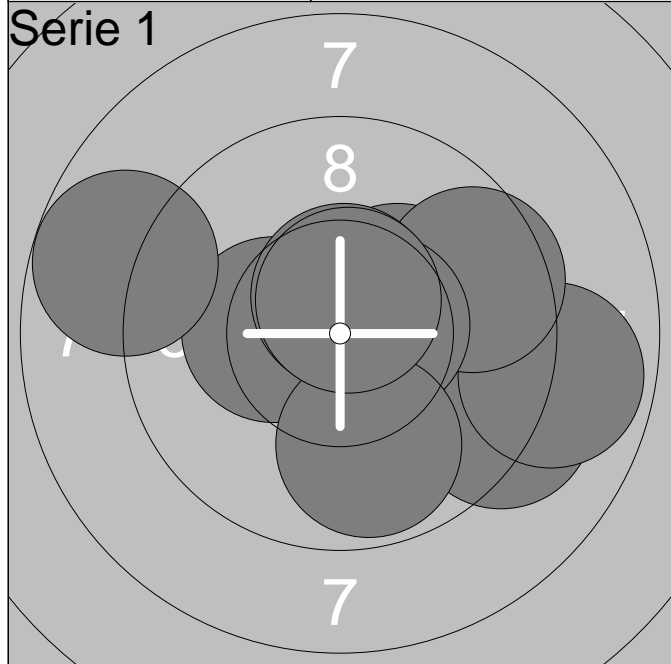

1:	10.3x	↗
2:	10.3x	←
3:	8.7	←
4:	9.2	↘
5:	8.9	→
6:	9.5	→
7:	10.6x	→
8:	10.6x	↑
9:	9.8	↓
10:	10.6x	↑
<b>Serie</b>		<b>93.0</b>
<b>Total</b>		<b>93.0</b>

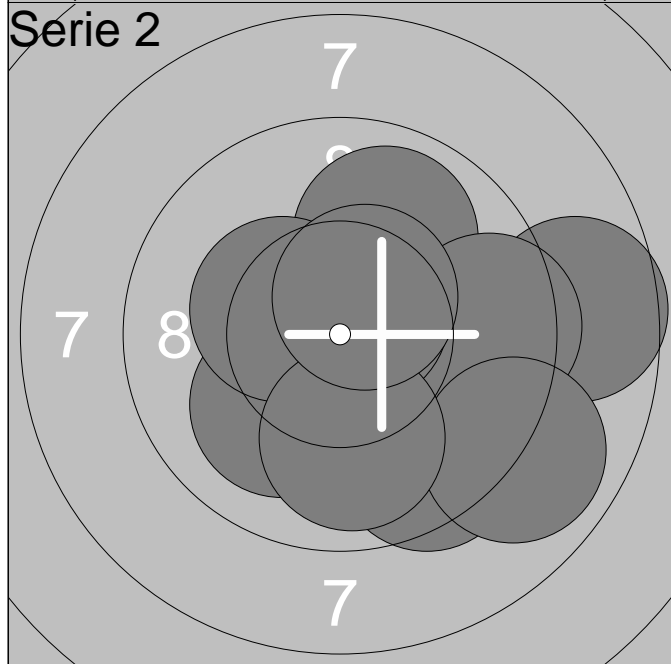

1:	9.9	↗
2:	9.5	↘
3:	8.6	→
4:	9.5	→
5:	8.9	↘
6:	10.7x	↗
7:	10.0	↙
8:	10.3x	↖
9:	9.9	↓
10:	10.5x	↗
<b>Serie</b>		<b>92.0</b>
<b>Total</b>		<b>185.0</b>

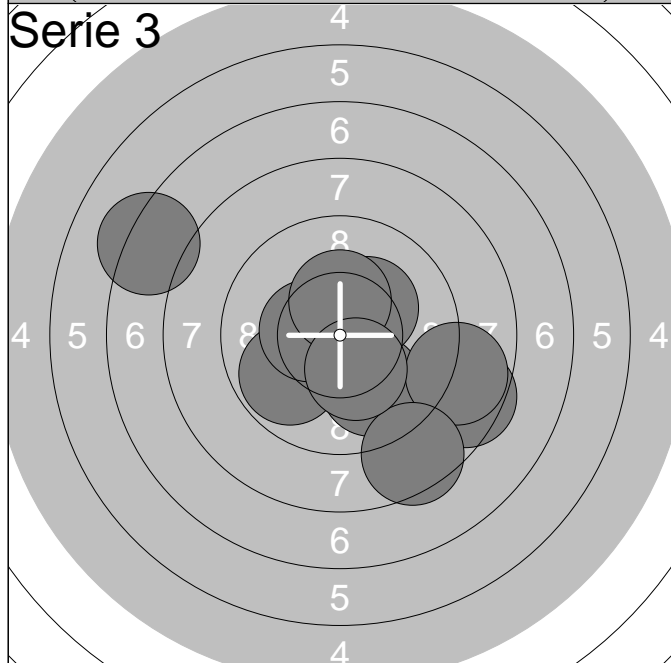

1:	9.9	↘
2:	8.5	↘
3:	8.8	→
4:	8.5	↘
5:	9.8	↙
6:	10.4x	←
7:	10.2x	↗
8:	7.2	↖
9:	10.3x	↑
10:	10.2x	↘
<b>Serie</b>		<b>89.0</b>
<b>Total</b>		<b>274.0</b>

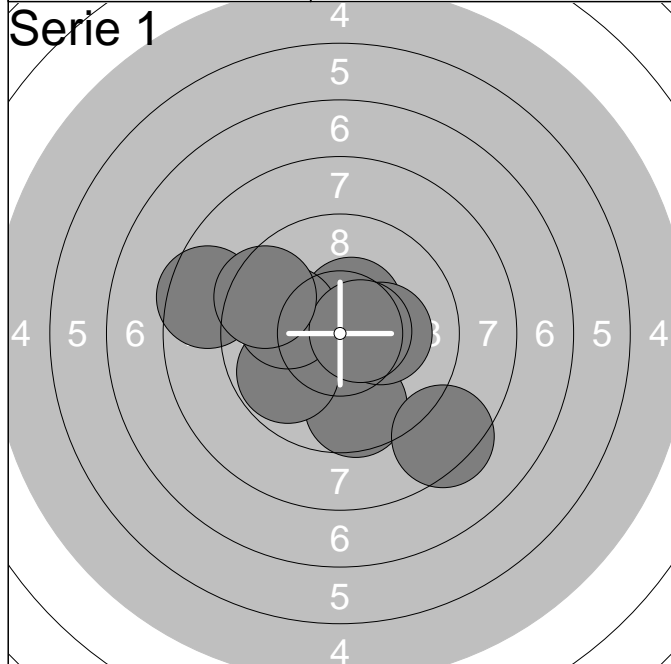

1:	10.6x	↗
2:	8.5	↖
3:	9.6	↓
4:	10.5x	↗
5:	9.8	↖
6:	10.2x	→
7:	10.0	↖
8:	10.6x	→
9:	8.4	↘
10:	9.5	↗
<b>Serie</b>		<b>93.0</b>
<b>Total</b>		<b>93.0</b>



1:	10.4x	↗
2:	9.3	↗
3:	9.8	↗
4:	10.3x	↗
5:	10.3x	↓
6:	10.2x	→
7:	10.7x	↗
8:	10.0	↖
9:	10.1	↗
10:	9.6	↗
<b>Serie</b>		<b>97.0</b>
<b>Total</b>		<b>190.0</b>

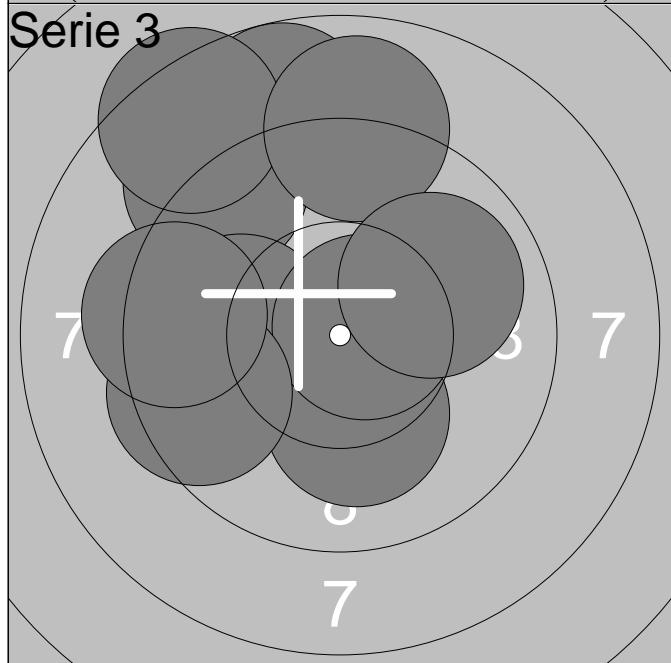

1:	8.7	↗
2:	9.0	↗
3:	10.0	↖
4:	10.1	↓
5:	10.7x	→
6:	8.4	↗
7:	9.5	↖
8:	9.3	↖
9:	8.9	↗
10:	9.9	↗
<b>Serie</b>		<b>90.0</b>
<b>Total</b>		<b>280.0</b>

Lag <b>4</b>	Skive <b>10</b>	<b>Simen Musdalslien</b>	
-----------------	--------------------	--------------------------	--

Luft	Gudbrandsdal Sportskyttere	R14	
------	----------------------------	-----	--

16.04.2015	Landsstevnet rekrutt 2015	LS Rekrutt 2015	
------------	---------------------------	-----------------	--

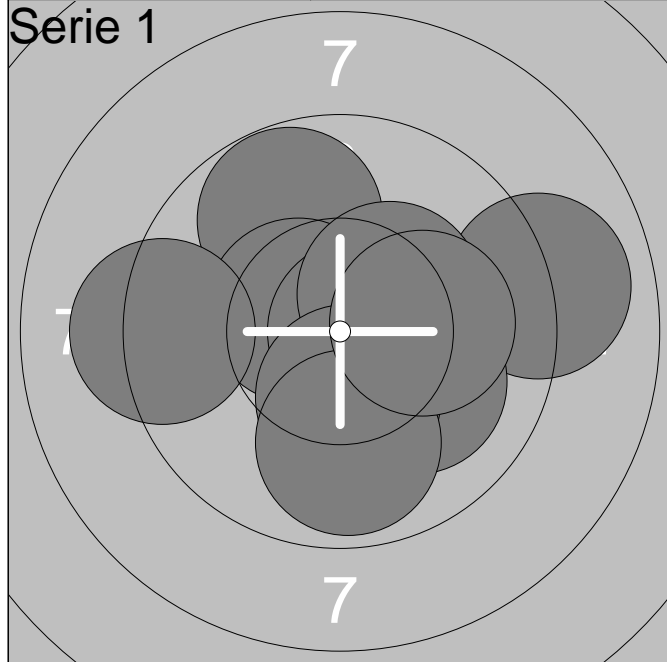

1:	9.7	↗
2:	10.5x	↖
3:	9.0	→
4:	10.1	↘
5:	10.7x	→
6:	9.2	←
7:	10.3x	↗
8:	10.3x	↓
9:	9.9	↓
10:	10.1	→
<b>Serie</b>		<b>96.0</b>
<b>Total</b>		<b>96.0</b>

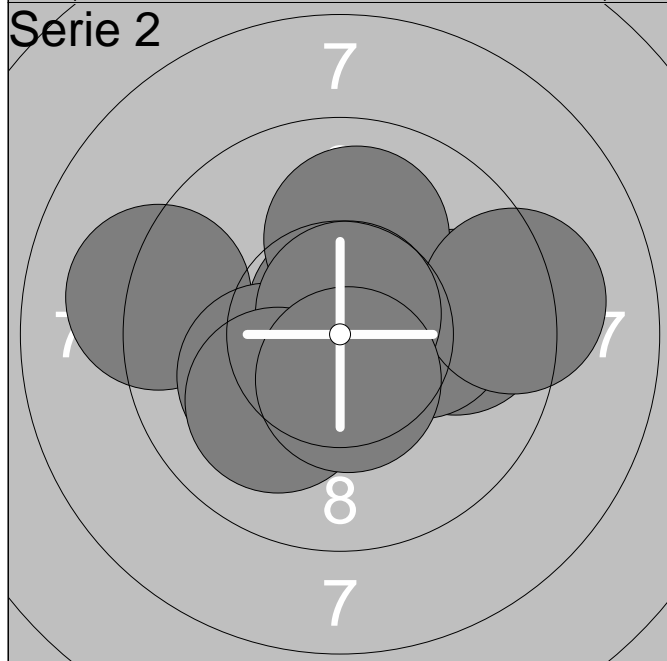

1:	9.8	→
2:	10.2x	→
3:	10.7x	↑
4:	9.1	←
5:	10.0	↑
6:	10.1	↖
7:	9.2	→
8:	10.7x	↑
9:	10.0	↖
10:	10.5x	↓
<b>Serie</b>		<b>97.0</b>
<b>Total</b>		<b>193.0</b>

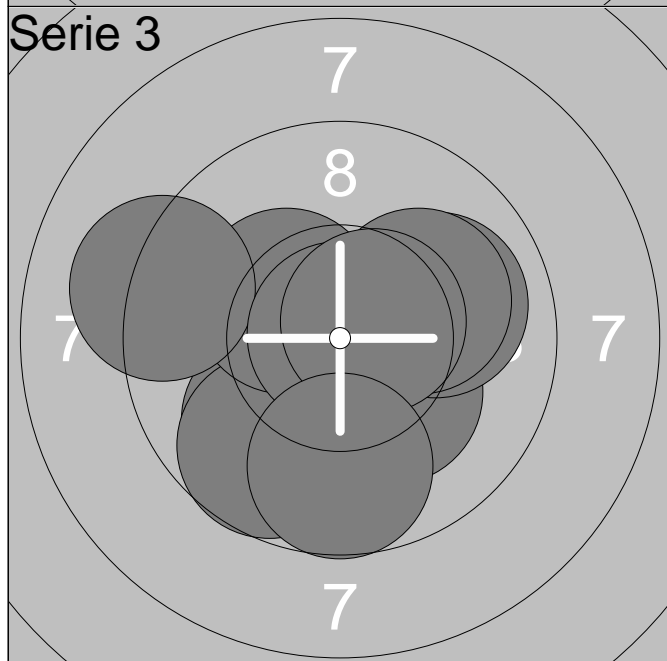

1:	10.2x	↘
2:	9.9	↖
3:	10.0	→
4:	10.1	→
5:	9.7	↖
6:	10.3x	↗
7:	9.1	←
8:	10.9x	↑
9:	10.6x	↗
10:	9.7	↓
<b>Serie</b>		<b>96.0</b>
<b>Total</b>		<b>289.0</b>

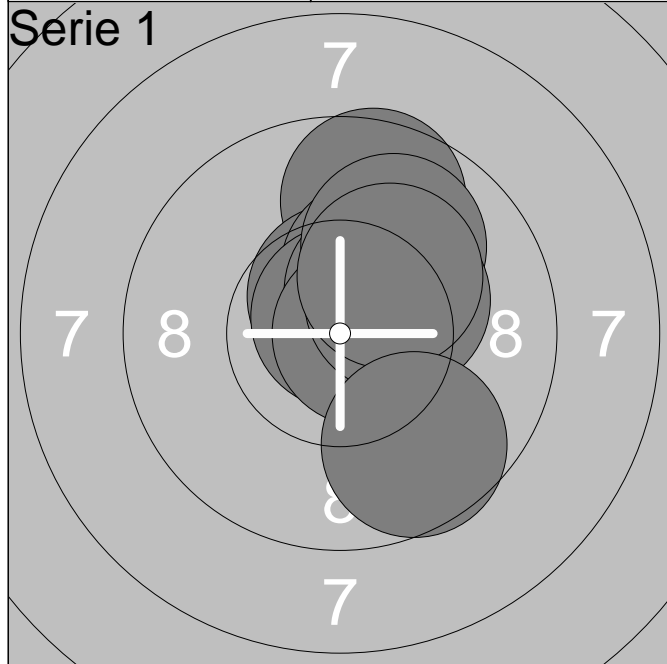

1:	9.6	↑
2:	10.6x	↑
3:	10.3x	↗
4:	10.7x	↑
5:	10.4x	↗
6:	9.9	↗
7:	10.7x	→
8:	10.3x	↗
9:	10.2x	↗
10:	9.6	↓
<b>Serie</b>		<b>97.0</b>
<b>Total</b>		<b>97.0</b>

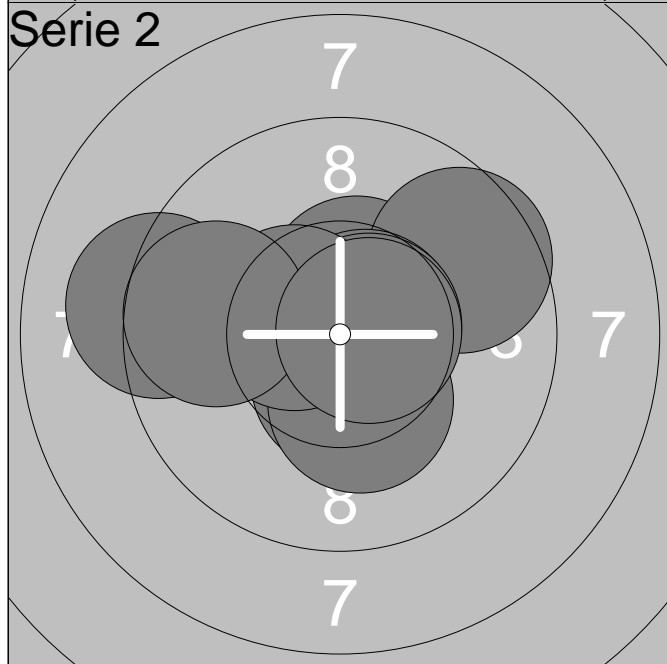

1:	10.5x	↑
2:	9.6	↗
3:	10.5x	↓
4:	9.1	←
5:	10.7x	↗
6:	10.6x	→
7:	10.3x	↓
8:	10.5x	←
9:	9.7	←
10:	10.6x	→
<b>Serie</b>		<b>97.0</b>
<b>Total</b>		<b>194.0</b>

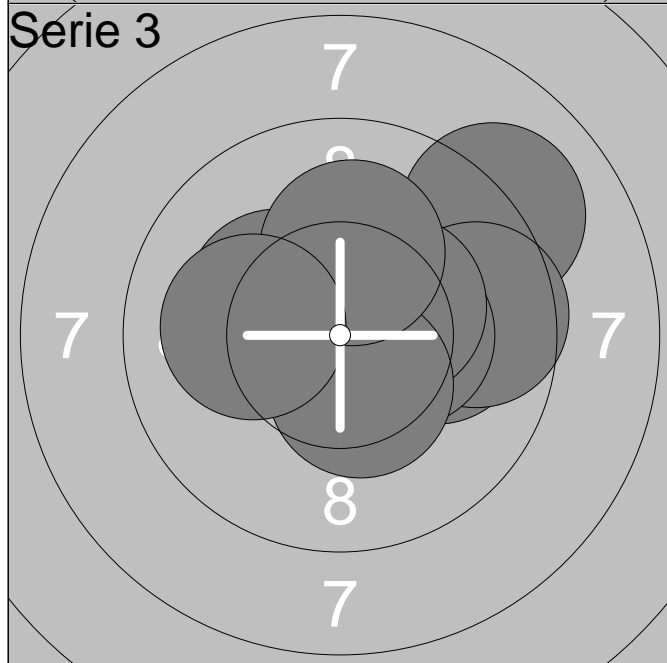

1:	10.7x	↗
2:	10.0	→
3:	9.1	↗
4:	10.2x	↖
5:	9.6	→
6:	10.3x	→
7:	10.3x	↗
8:	10.4x	↓
9:	10.1	↑
10:	10.1	←
<b>Serie</b>		<b>98.0</b>
<b>Total</b>		<b>292.0</b>

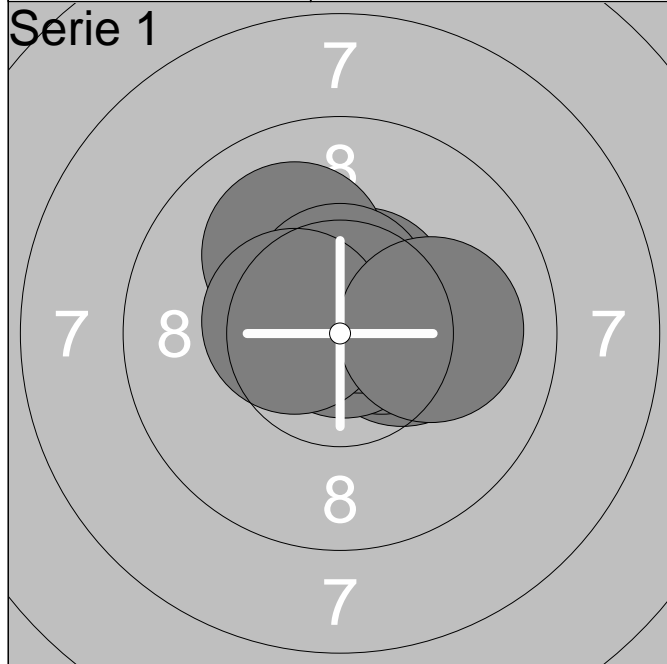

1:	10.7x	↑
2:	10.3x	→
3:	10.7x	↑
4:	10.5x	→
5:	10.8x	↗
6:	10.6x	↗
7:	10.1	↖
8:	10.6x	↑
9:	10.5x	←
10:	10.0	→

Serie	100.0
Total	100.0

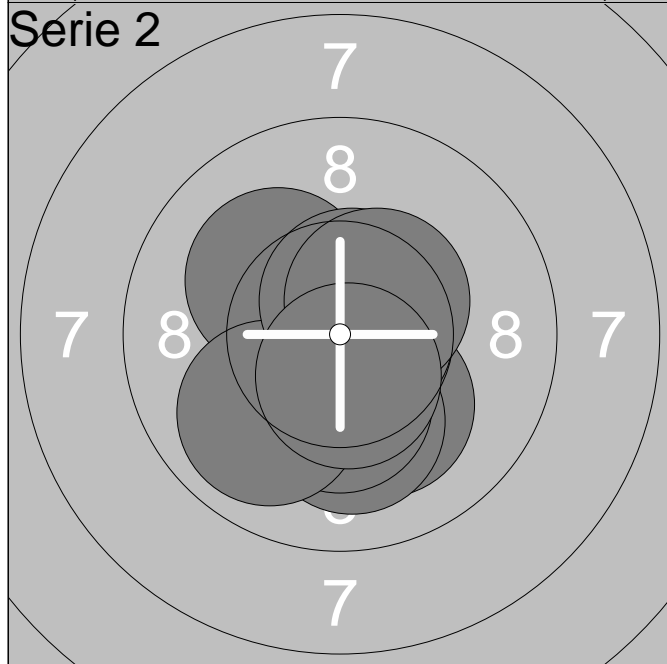

1:	10.1	↓
2:	10.8x	↑
3:	10.1	↓
4:	10.1	↖
5:	10.3x	↓
6:	9.9	↙
7:	10.7x	→
8:	10.6x	↑
9:	10.5x	↗
10:	10.5x	↓

Serie	99.0
Total	199.0



1:	10.0	↙
2:	10.3x	↓
3:	10.7x	↗
4:	10.4x	↓
5:	10.1	→
6:	10.5x	↑
7:	9.8	→
8:	9.3	↓
9:	10.4x	↗
10:	10.3x	↑

Serie	98.0
Total	297.0

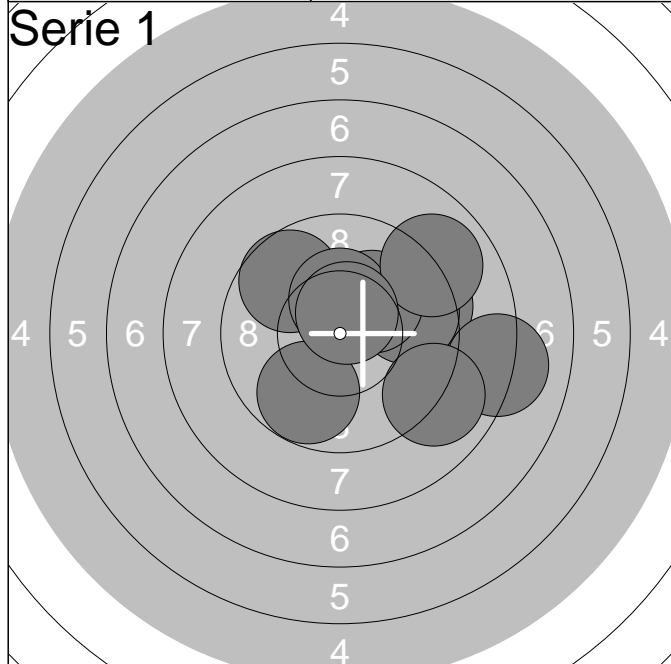

1:	9.6	↖
2:	9.4	→
3:	9.7	→
4:	10.1	↗
5:	8.1	→
6:	10.3x	↑
7:	9.7	↙
8:	8.9	↗
9:	10.5x	↑
10:	9.0	↘
<b>Serie</b>		<b>91.0</b>
<b>Total</b>		<b>91.0</b>



1:	9.0	↘
2:	10.0	↗
3:	10.2x	→
4:	10.5x	↘
5:	9.9	↖
6:	10.1	→
7:	10.3x	↑
8:	9.4	→
9:	9.9	↗
10:	10.2x	↑
<b>Serie</b>		<b>96.0</b>
<b>Total</b>		<b>187.0</b>

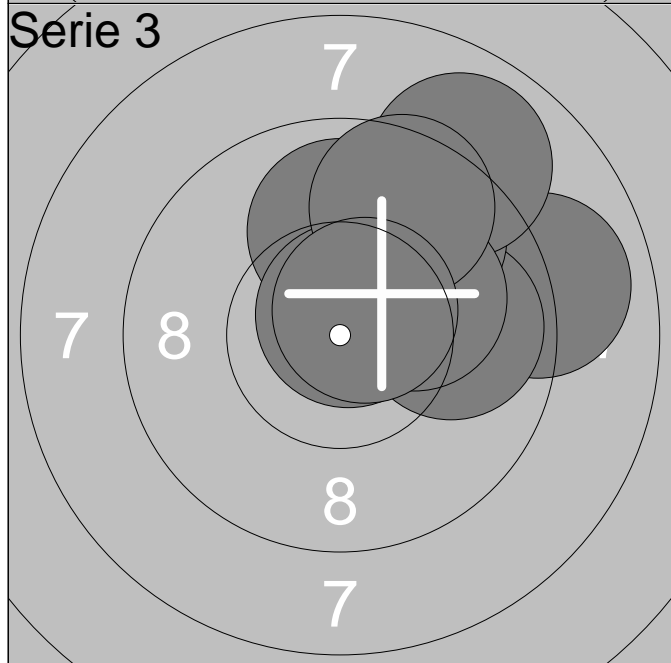

1:	9.9	→
2:	9.9	↑
3:	9.0	→
4:	10.7x	↑
5:	9.9	→
6:	9.7	↗
7:	8.9	↗
8:	10.1	→
9:	9.6	↑
10:	10.6x	↗
<b>Serie</b>		<b>92.0</b>
<b>Total</b>		<b>279.0</b>

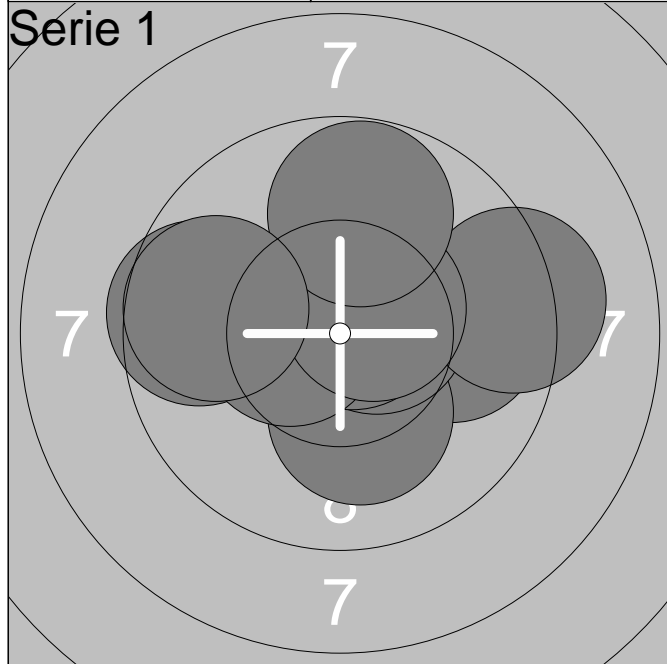

1:	9.6	↔
2:	9.9	→
3:	10.1	↓
4:	10.5x	→
5:	10.7x	↗
6:	10.5x	←
7:	9.2	→
8:	10.5x	↗
9:	9.7	↑
10:	9.7	↔
<b>Serie</b>		<b>95.0</b>
<b>Total</b>		<b>95.0</b>

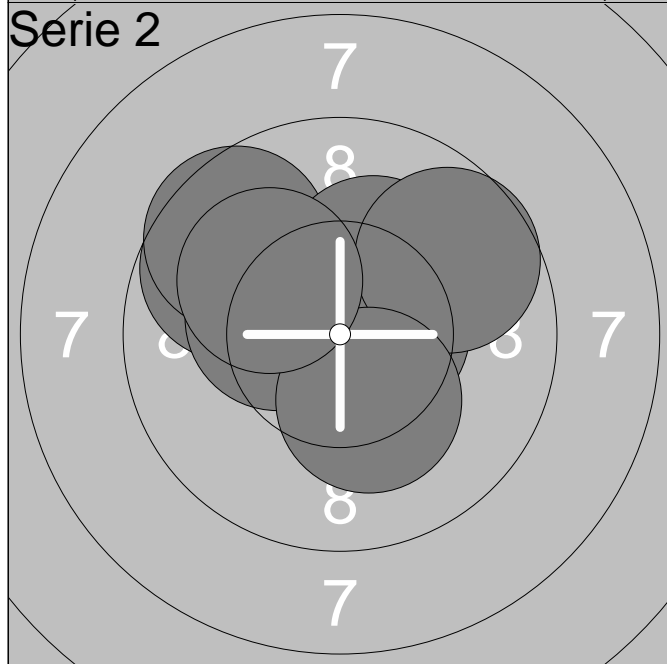

1:	9.7	↗
2:	10.6x	↗
3:	10.6x	→
4:	10.4x	↖
5:	9.6	↗
6:	10.2x	↗
7:	10.3x	↖
8:	9.7	↗
9:	10.2x	↓
10:	10.1	↗
<b>Serie</b>		<b>97.0</b>
<b>Total</b>		<b>192.0</b>



1:	10.1	↑
2:	10.2x	→
3:	10.9x	
4:	10.6x	→
5:	10.7x	→
6:	10.1	↗
7:	10.4x	←
8:	9.9	↓
9:	10.8x	↗
10:	10.3x	↗
<b>Serie</b>		<b>99.0</b>
<b>Total</b>		<b>291.0</b>



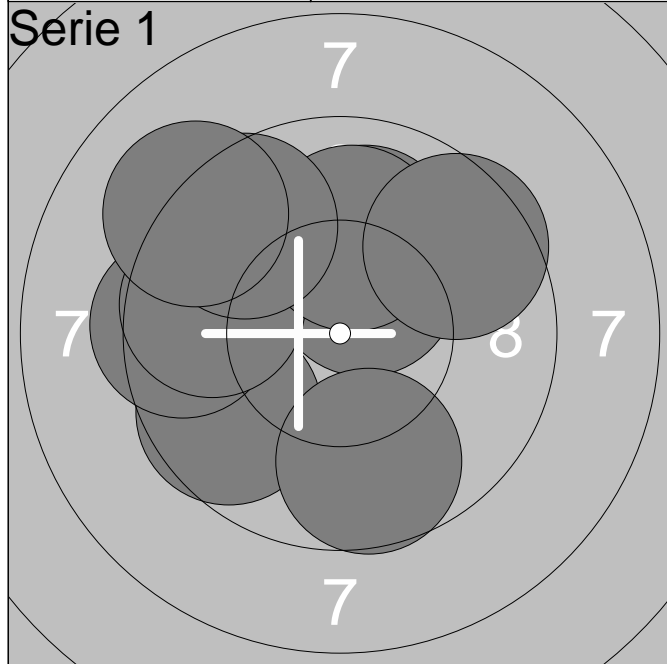

1:	10.0	↑
2:	9.6	↙
3:	10.4x	↑
4:	9.4	←
5:	9.7	←
6:	10.0	↑
7:	9.5	↗
8:	9.5	↗
9:	9.7	↓
10:	9.1	↖
<b>Serie</b>		<b>93.0</b>
<b>Total</b>		<b>93.0</b>

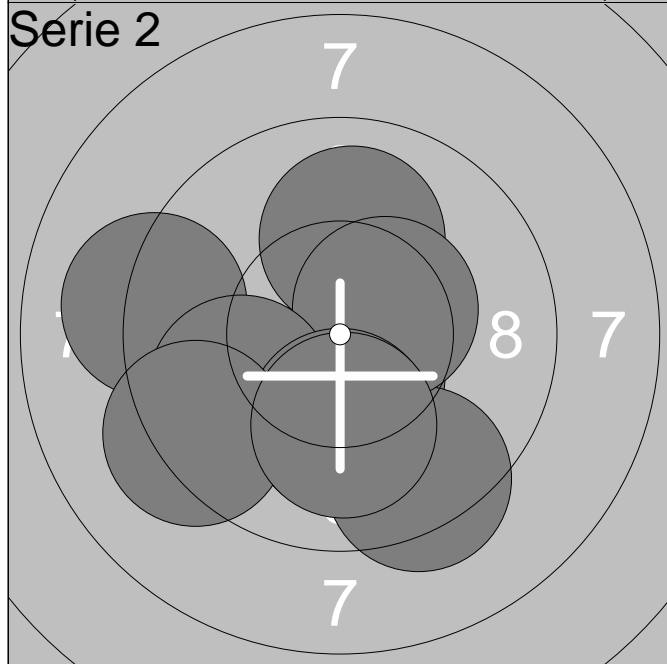

1:	9.1	←
2:	10.4x	↓
3:	10.5x	↓
4:	10.0	↑
5:	9.3	↓
6:	10.4x	↗
7:	9.8	←
8:	10.1	↓
9:	9.2	↙
10:	10.1	↓
<b>Serie</b>		<b>96.0</b>
<b>Total</b>		<b>189.0</b>

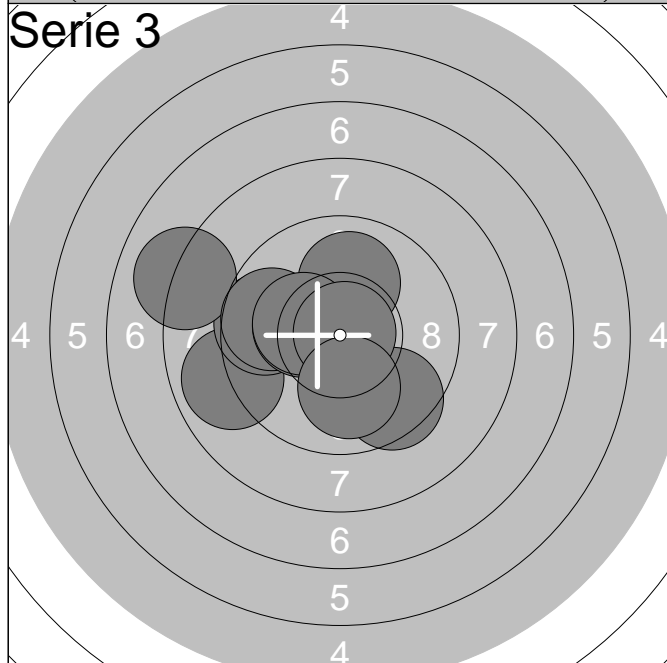

1:	8.9	←
2:	9.6	←
3:	8.0	←
4:	10.0	↑
5:	9.5	↓
6:	9.7	←
7:	10.3x	←
8:	10.3x	←
9:	10.8x	↗
10:	10.0	↓
<b>Serie</b>		<b>93.0</b>
<b>Total</b>		<b>282.0</b>

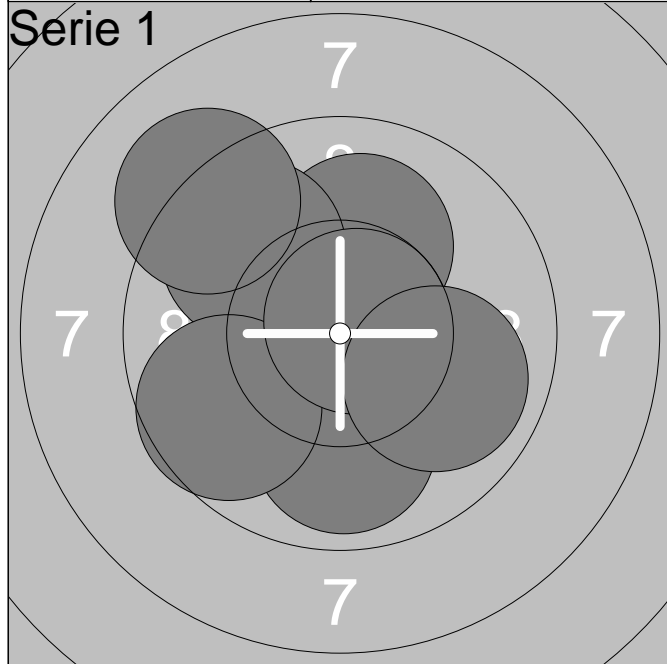

1:	10.6x	↑
2:	10.5x	↓
3:	10.4x	↗
4:	10.1	↑
5:	9.8	↗
6:	9.9	↓
7:	9.6	↖
8:	9.1	↗
9:	10.7x	↗
10:	9.9	↘
<b>Serie</b>		<b>95.0</b>
<b>Total</b>		<b>95.0</b>

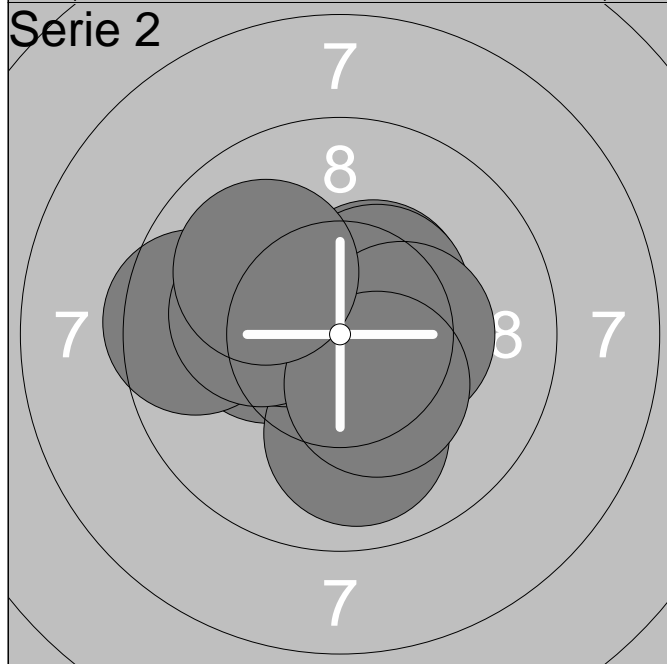

1:	10.3x	←
2:	9.5	←
3:	10.4x	↗
4:	10.4x	↗
5:	9.9	↓
6:	10.4x	↖
7:	10.3x	→
8:	10.1	←
9:	10.3x	↓
10:	10.0	↗
<b>Serie</b>		<b>98.0</b>
<b>Total</b>		<b>193.0</b>

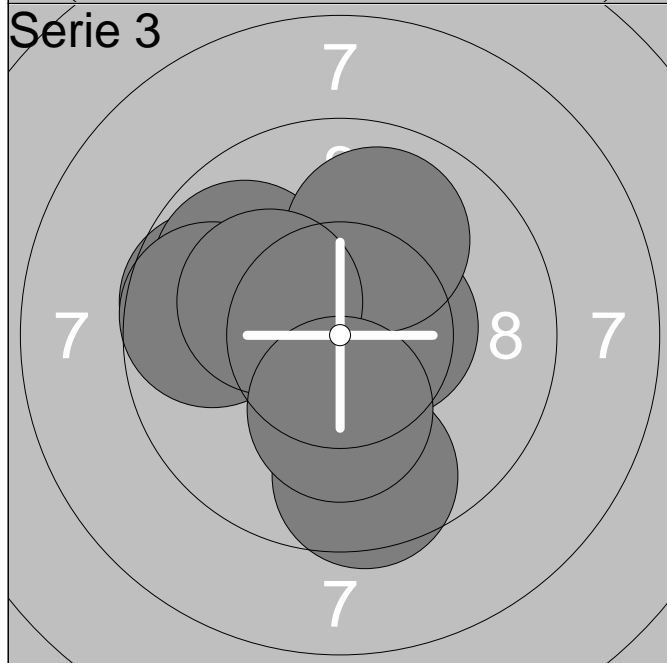

1:	10.4x	↖
2:	10.5x	↗
3:	9.6	←
4:	9.8	↗
5:	10.5x	→
6:	9.6	↓
7:	9.9	↑
8:	9.7	←
9:	10.2x	↗
10:	10.2x	↓
<b>Serie</b>		<b>95.0</b>
<b>Total</b>		<b>288.0</b>

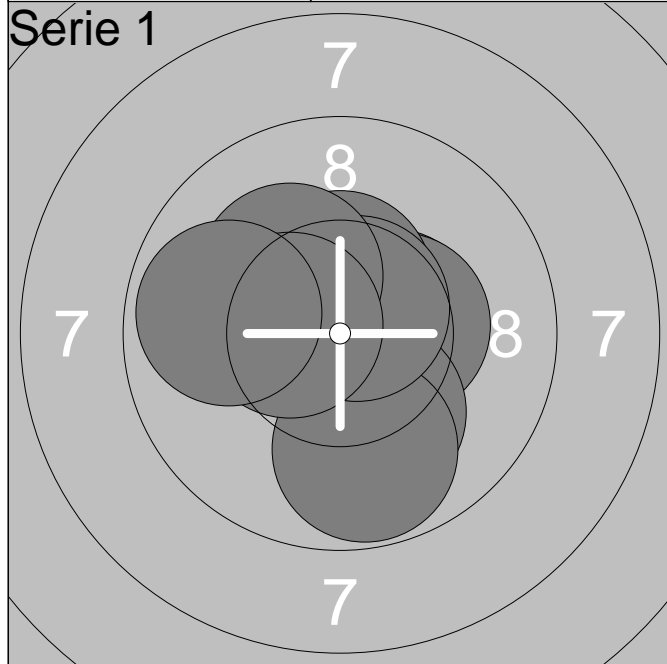

1:	10.4x	→
2:	10.4x	→
3:	10.8x	↑
4:	10.1	↓
5:	10.4x	↑
6:	9.8	↓
7:	10.6x	↗
8:	10.2x	↗
9:	10.4x	←
10:	9.8	←
<b>Serie</b>		<b>98.0</b>
<b>Total</b>		<b>98.0</b>

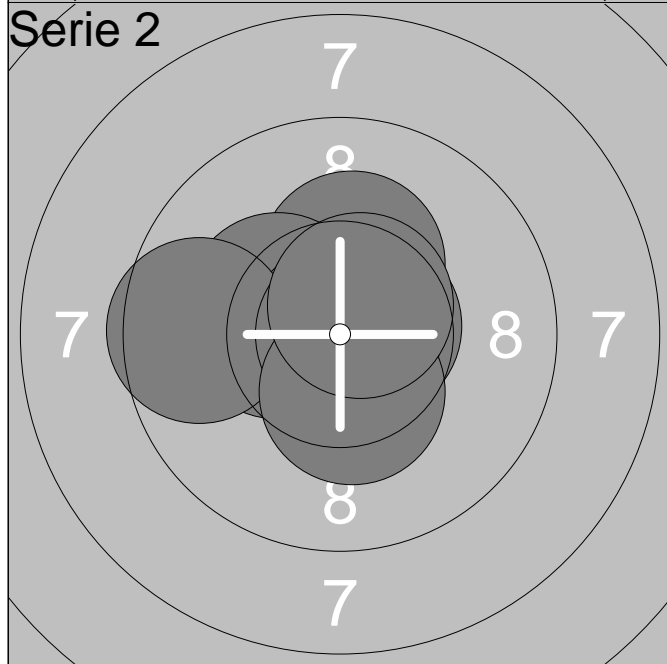

1:	10.3x	←
2:	10.8x	↗
3:	10.2x	↑
4:	10.3x	←
5:	10.6x	→
6:	10.9x	←
7:	9.6	←
8:	10.9x	→
9:	10.4x	↓
10:	10.6x	↗
<b>Serie</b>		<b>99.0</b>
<b>Total</b>		<b>197.0</b>



1:	10.7x	↗
2:	10.0	←
3:	10.2x	↑
4:	9.9	↓
5:	10.6x	↗
6:	10.0	←
7:	10.9x	↑
8:	10.2x	←
9:	10.7x	↗
10:	10.7x	↗
<b>Serie</b>		<b>99.0</b>
<b>Total</b>		<b>296.0</b>

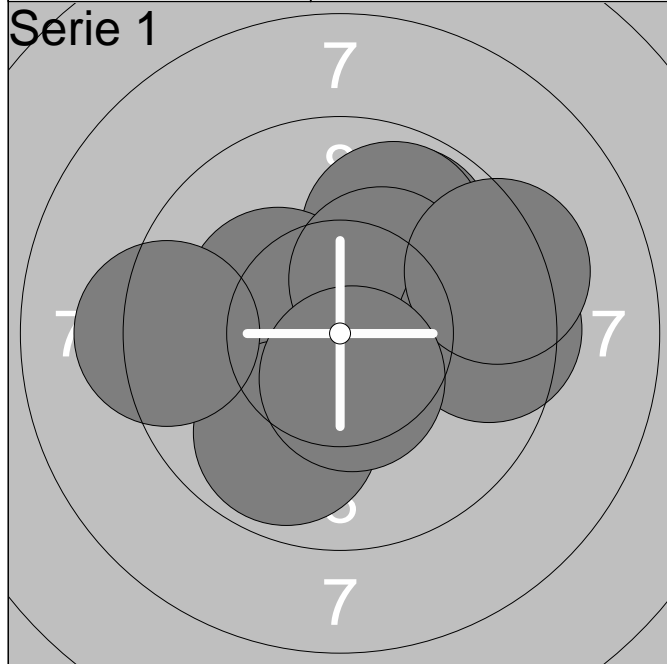

1:	9.8	↗
2:	9.8	↗
3:	10.3x	↙
4:	10.2x	↖
5:	10.3x	↗
6:	9.5	→
7:	9.3	↗
8:	9.8	↙
9:	9.3	←
10:	10.5x	↓
<b>Serie</b>		<b>94.0</b>
<b>Total</b>		<b>94.0</b>

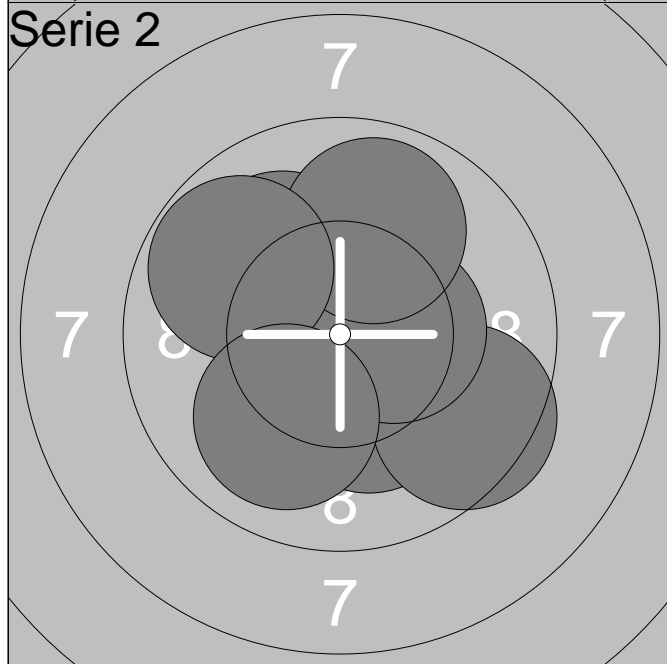

1:	10.7x	→
2:	10.4x	↓
3:	10.2x	↓
4:	10.6x	→
5:	9.5	↙
6:	10.0	↗
7:	10.4x	→
8:	9.9	↑
9:	9.8	↗
10:	10.0	↙
<b>Serie</b>		<b>97.0</b>
<b>Total</b>		<b>191.0</b>

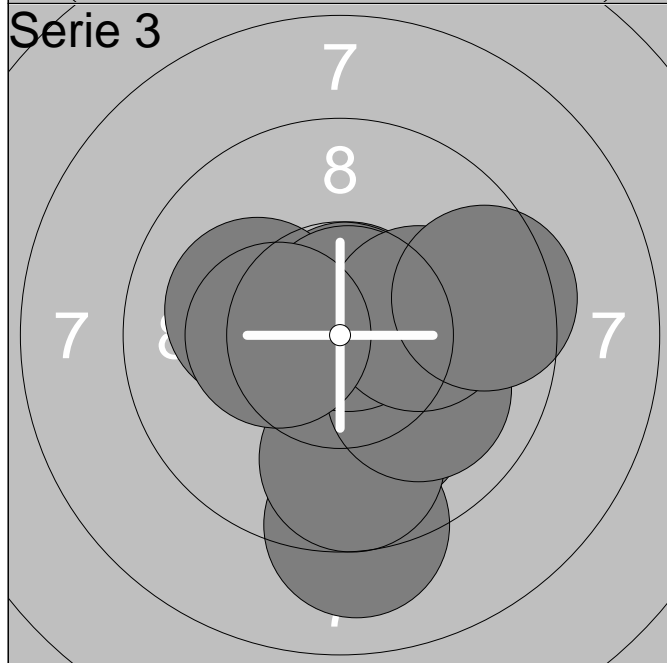

1:	10.1	↓
2:	9.1	↓
3:	9.7	↓
4:	10.7x	↗
5:	10.0	↙
6:	10.1	↖
7:	10.7x	↗
8:	10.2x	→
9:	9.5	→
10:	10.3x	←
<b>Serie</b>		<b>97.0</b>
<b>Total</b>		<b>288.0</b>

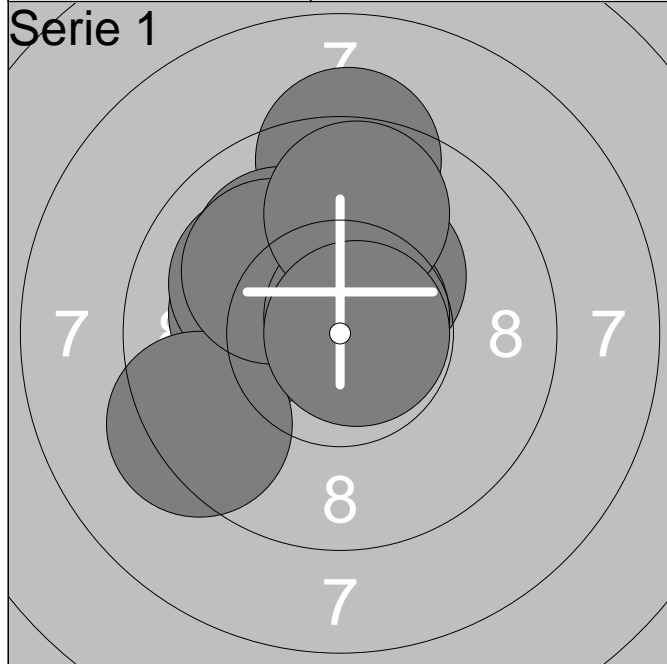

1:	10.1	↖
2:	9.2	↑
3:	10.0	↖
4:	9.3	↙
5:	10.3x	↗
6:	10.0	↗
7:	10.1	↖
8:	10.7x	↗
9:	9.8	↑
10:	10.8x	→
<b>Serie</b>		<b>97.0</b>
<b>Total</b>		<b>97.0</b>

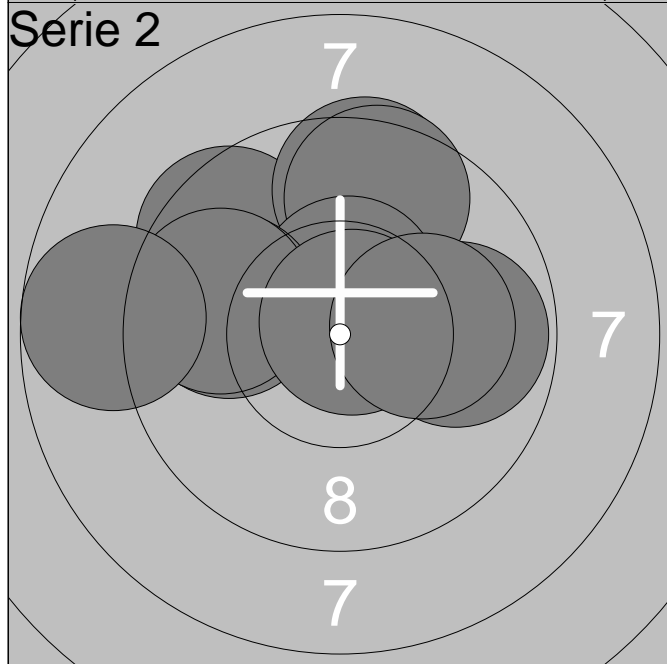

1:	9.5	↖
2:	9.5	↑
3:	9.6	↑
4:	10.5x	↑
5:	9.8	→
6:	9.8	↖
7:	9.7	↖
8:	10.8x	↗
9:	8.7	↖
10:	10.1	→
<b>Serie</b>		<b>92.0</b>
<b>Total</b>		<b>189.0</b>



1:	10.7x	↑
2:	10.4x	→
3:	10.3x	↑
4:	10.2x	↘
5:	10.5x	↖
6:	10.5x	↖
7:	10.8x	↗
8:	9.9	→
9:	10.6x	→
10:	10.1	↘
<b>Serie</b>		<b>99.0</b>
<b>Total</b>		<b>288.0</b>

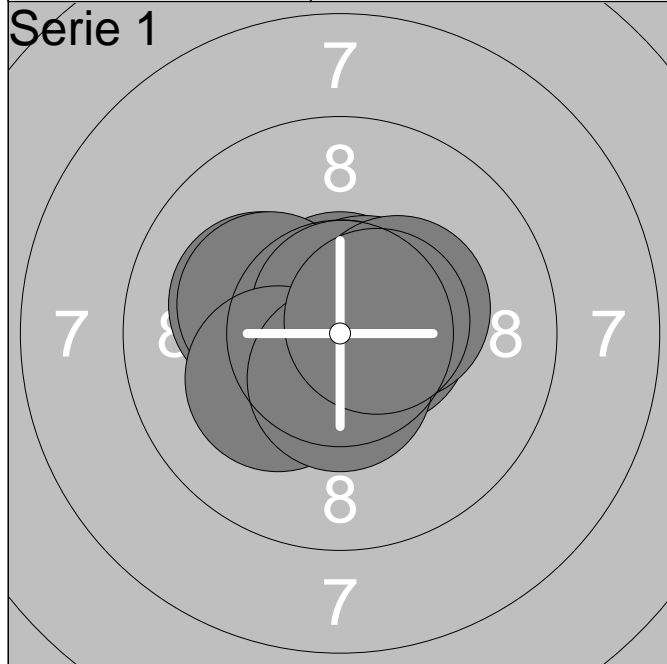

1:	10.1	↖
2:	10.7x	↑
3:	10.6x	→
4:	10.2x	↖
5:	10.6x	↗
6:	10.7x	↑
7:	10.2x	↙
8:	10.3x	→
9:	10.5x	↓
10:	10.6x	→
<b>Serie</b>		<b>100.0</b>
<b>Total</b>		<b>100.0</b>

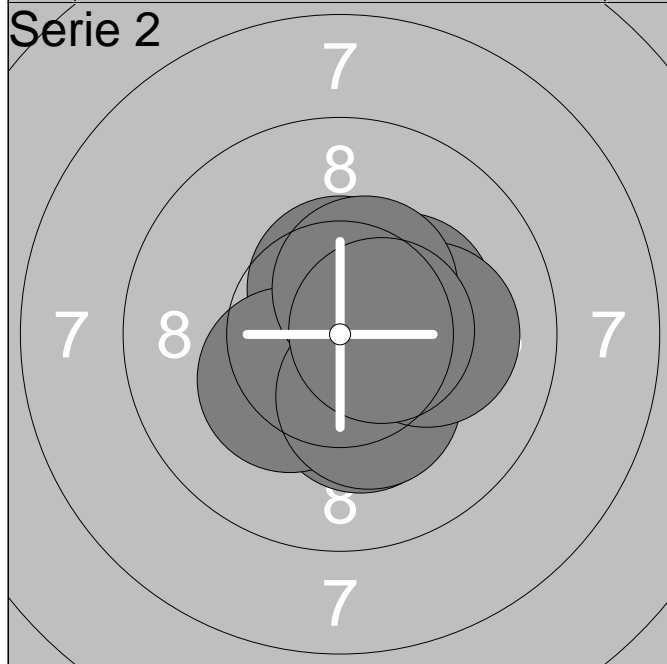

1:	10.5x	↘
2:	10.4x	→
3:	10.3x	→
4:	10.5x	↑
5:	10.2x	↘
6:	10.3x	↙
7:	10.3x	↘
8:	10.1	→
9:	10.4x	↗
10:	10.5x	→
<b>Serie</b>		<b>100.0</b>
<b>Total</b>		<b>200.0</b>

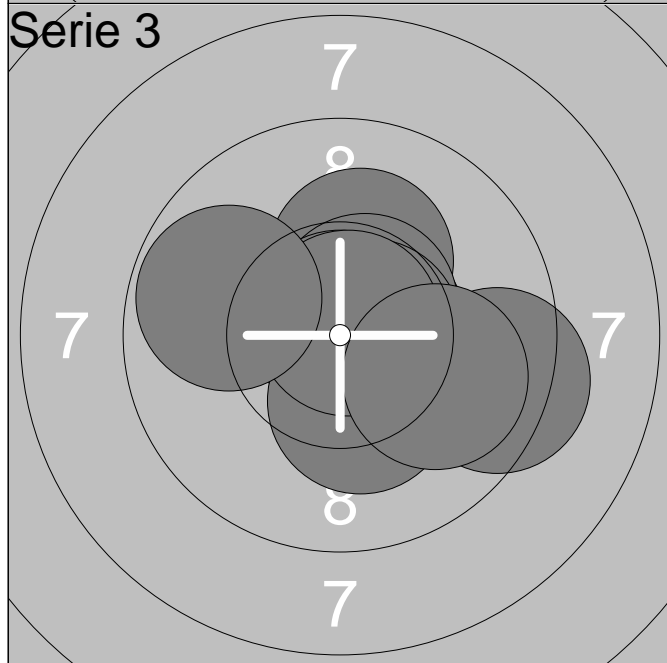

1:	10.6x	→
2:	10.2x	↑
3:	10.6x	↗
4:	9.4	→
5:	10.8x	↑
6:	10.7x	→
7:	10.3x	↘
8:	10.8x	↗
9:	9.8	↖
10:	9.9	↘
<b>Serie</b>		<b>97.0</b>
<b>Total</b>		<b>297.0</b>

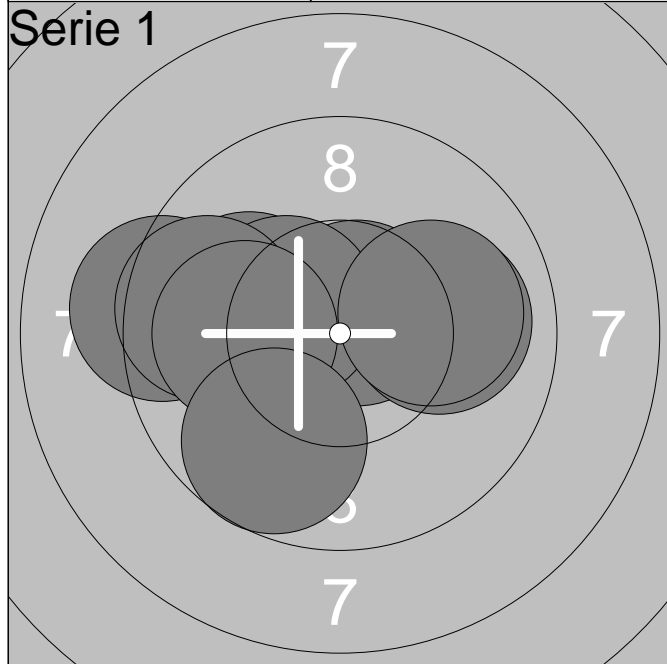

1:	10.4x	←
2:	10.7x	↗
3:	9.2	←
4:	10.0	←
5:	10.4x	↖
6:	9.6	←
7:	10.0	←
8:	9.7	↙
9:	10.0	→
10:	10.0	→
<b>Serie</b>		<b>97.0</b>
<b>Total</b>		<b>97.0</b>

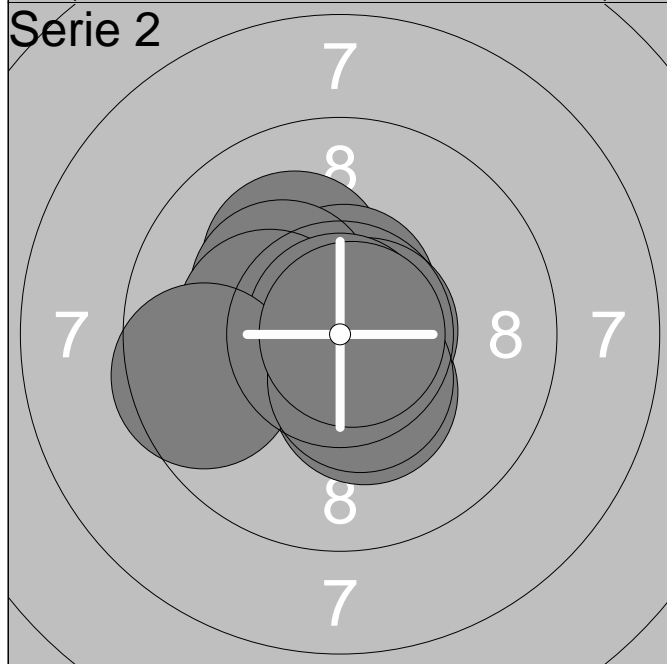

1:	10.3x	↘
2:	10.1	↗
3:	10.6x	↑
4:	10.2x	↖
5:	10.7x	→
6:	10.3x	←
7:	10.9x	↑
8:	9.6	←
9:	10.4x	↘
10:	10.8x	→
<b>Serie</b>		<b>99.0</b>
<b>Total</b>		<b>196.0</b>



1:	10.2x	↖
2:	10.7x	→
3:	10.5x	↘
4:	10.2x	↗
5:	10.7x	→
6:	10.0	↑
7:	10.4x	↑
8:	10.6x	↑
9:	10.3x	↑
10:	10.5x	→
<b>Serie</b>		<b>100.0</b>
<b>Total</b>		<b>296.0</b>

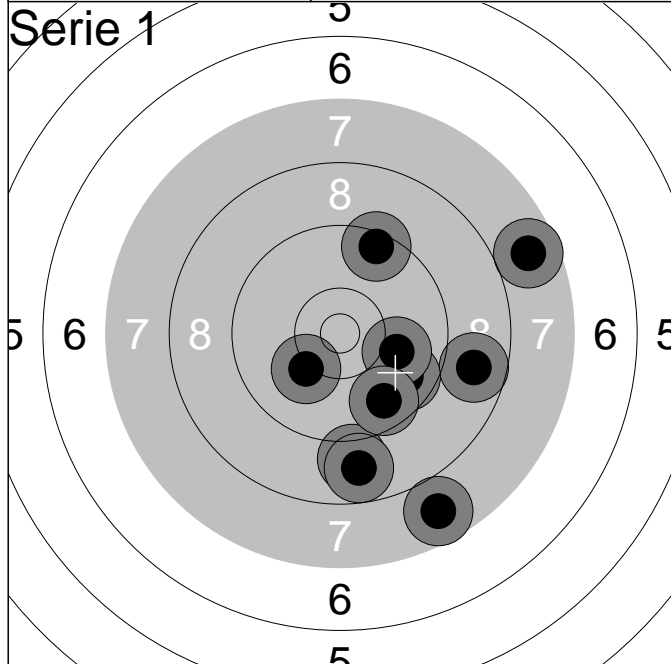

1:	7.7	↘
2:	8.7	→
3:	8.9	↘
4:	9.4	↗
5:	9.7	↘
6:	10.0	→
7:	9.7	↘
8:	8.8	↘
9:	10.2	↙
10:	7.7	→
<b>Serie</b>		<b>85.0</b>
<b>Total</b>		<b>85.0</b>

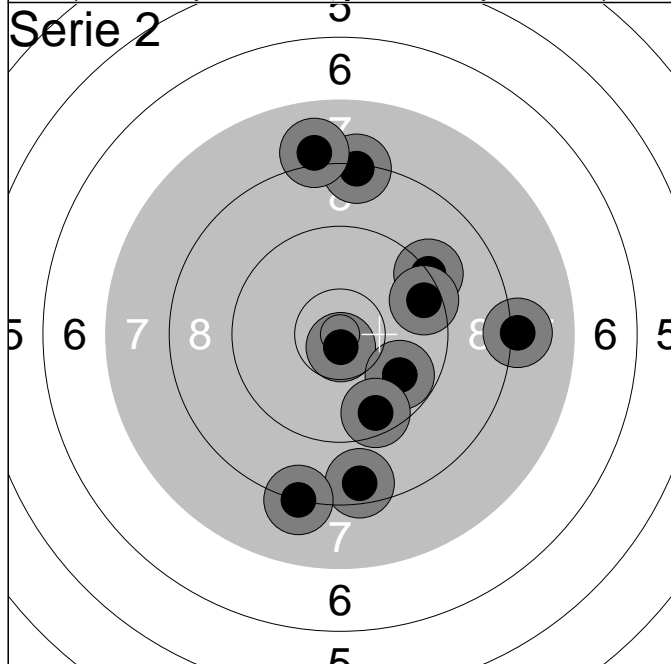

1:	10.7x	↓
2:	9.8	↘
3:	8.3	↑
4:	9.2	↗
5:	8.6	↘
6:	8.0	↑
7:	8.2	↘
8:	9.6	↘
9:	8.1	→
10:	9.5	↗
<b>Serie</b>		<b>86.0</b>
<b>Total</b>		<b>171.0</b>

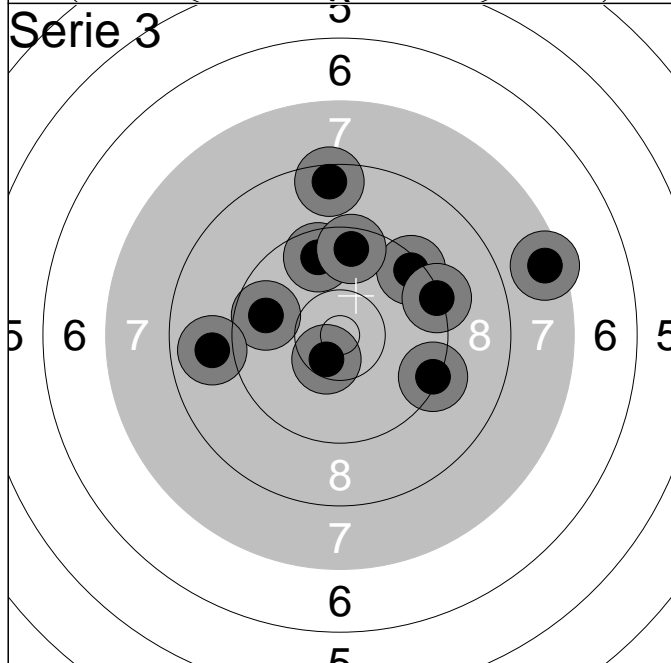

1:	9.7	←
2:	9.4	↗
3:	9.3	→
4:	10.5x	↘
5:	7.5	→
6:	8.5	↑
7:	9.3	→
8:	8.9	←
9:	9.7	↑
10:	9.6	↑
<b>Serie</b>		<b>87.0</b>
<b>Total</b>		<b>258.0</b>



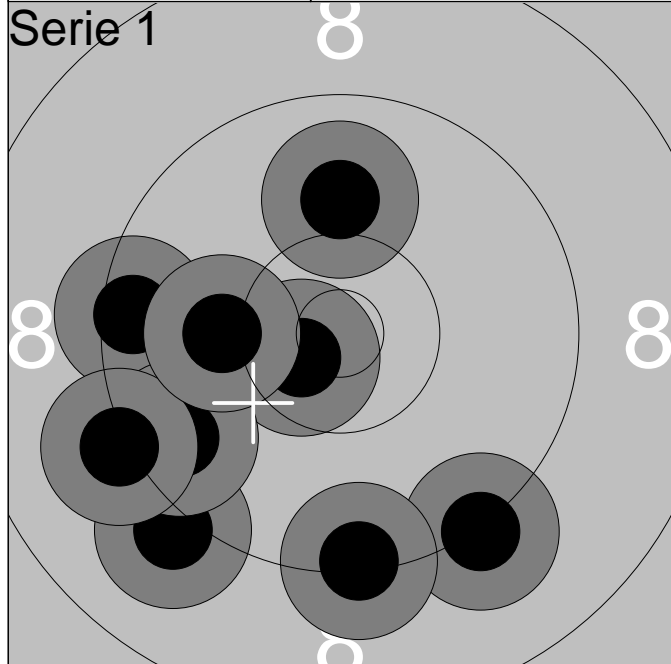

1:	9.3	↙
2:	10.6x	↙
3:	9.4	←
4:	9.2	↘
5:	9.1	↙
6:	9.6	↙
7:	9.2	←
8:	9.3	↓
9:	10.1	←
10:	10.0	↑
<b>Serie</b>		<b>93.0</b>
<b>Total</b>		<b>93.0</b>

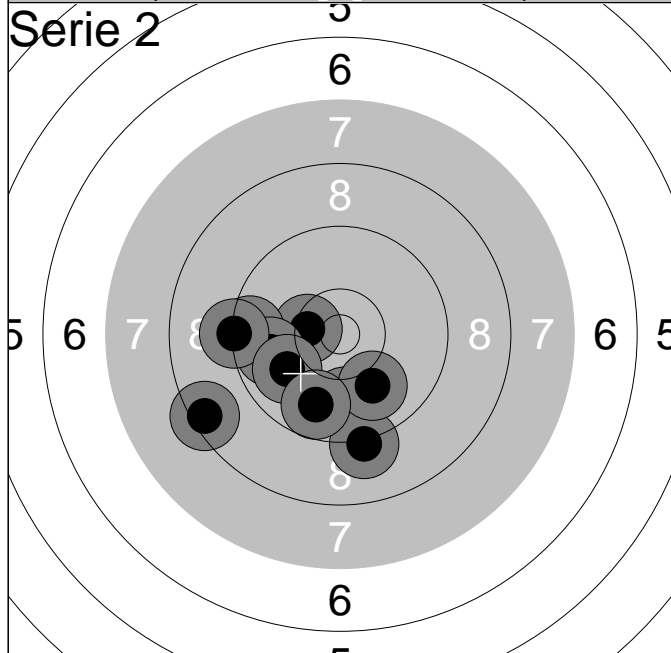

1:	10.4x	←
2:	9.9	↓
3:	9.5	←
4:	9.8	←
5:	9.2	↓
6:	9.3	←
7:	9.9	↙
8:	10.0	↓
9:	8.4	↙
10:	9.8	↓
<b>Serie</b>		<b>91.0</b>
<b>Total</b>		<b>184.0</b>

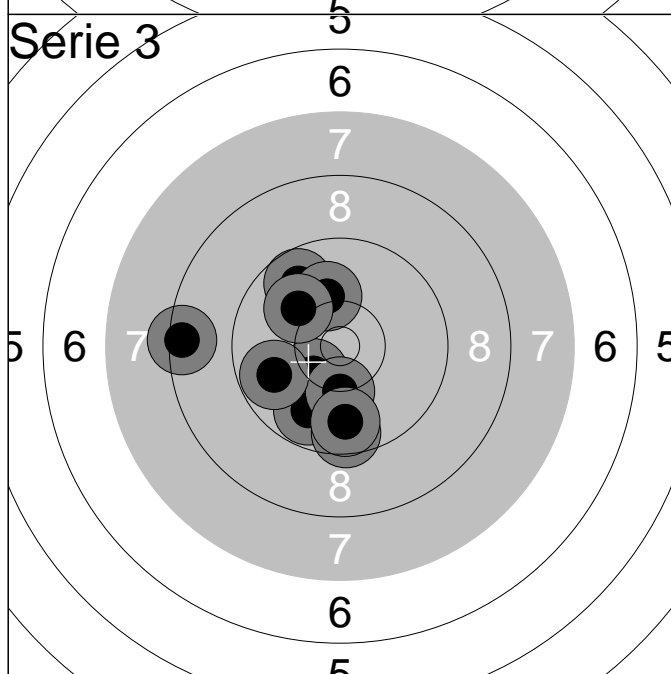

1:	9.7	↗
2:	8.4	←
3:	10.1	↑
4:	10.3	↙
5:	9.8	↙
6:	9.5	↓
7:	10.2	↓
8:	9.7	↓
9:	9.8	↙
10:	10.0	↖
<b>Serie</b>		<b>93.0</b>
<b>Total</b>		<b>277.0</b>

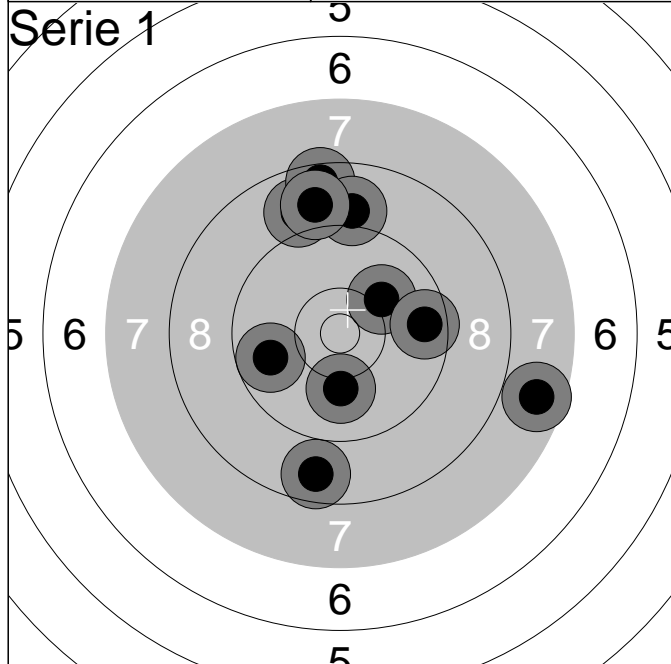

1:	9.8	←
2:	10.1	↓
3:	8.7	↓
4:	7.7	→
5:	10.1	↗
6:	8.9	↑
7:	8.5	↑
8:	9.0	↑
9:	8.9	↑
10:	9.6	→
<b>Serie</b>		<b>86.0</b>
<b>Total</b>		<b>86.0</b>

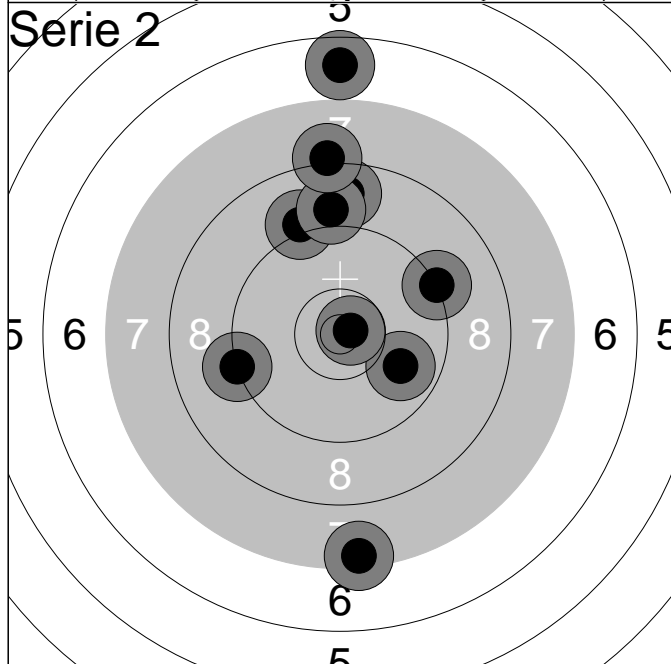

1:	8.7	↑
2:	9.9	→
3:	7.4	↓
4:	9.2	↗
5:	6.7	↑
6:	9.1	↑
7:	9.0	↑
8:	8.1	↑
9:	10.8x	→
10:	9.2	←
<b>Serie</b>		<b>84.0</b>
<b>Total</b>		<b>170.0</b>

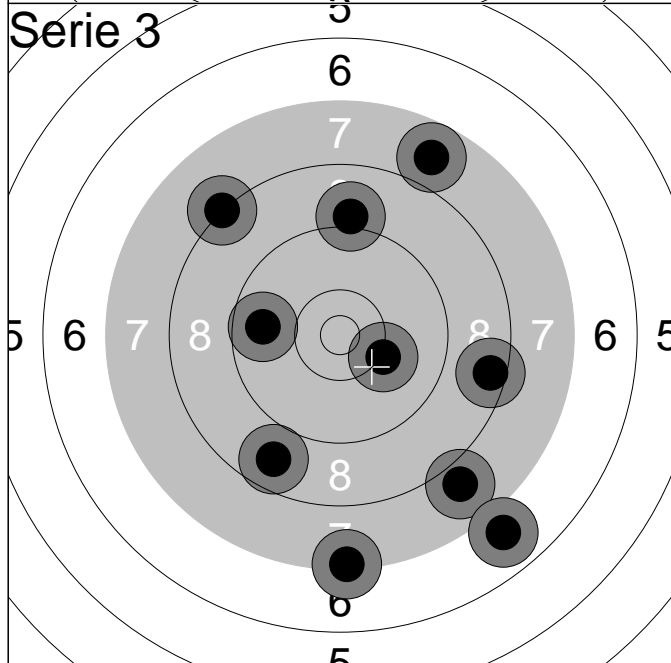

1:	7.3	↓
2:	10.2	→
3:	7.9	↓
4:	8.2	↗
5:	8.7	↓
6:	9.0	↑
7:	7.8	↗
8:	6.9	↓
9:	8.5	→
10:	9.7	←
<b>Serie</b>		<b>79.0</b>
<b>Total</b>		<b>249.0</b>

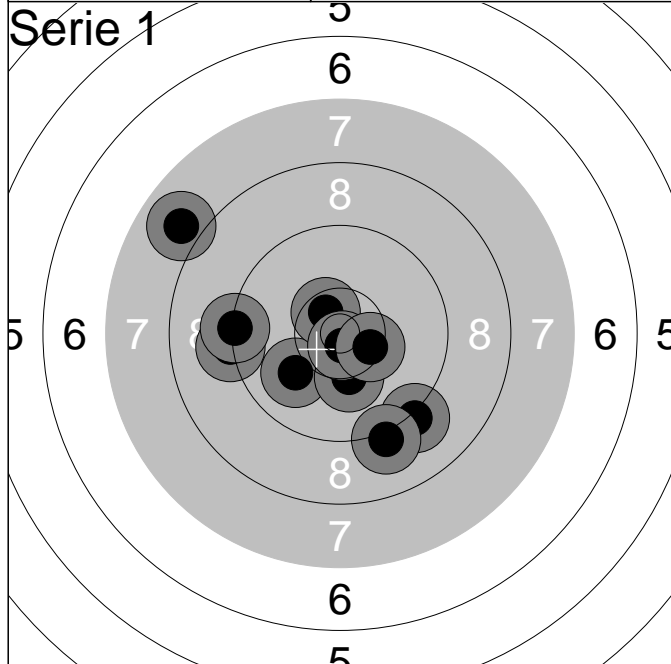

1:	10.0	↙
2:	10.5x	↗
3:	9.2	↖
4:	9.1	↘
5:	9.1	↘
6:	10.2	↘
7:	7.9	↗
8:	9.3	↖
9:	10.8x	↘
10:	10.4x	↘
<b>Serie</b>		<b>93.0</b>
<b>Total</b>		<b>93.0</b>

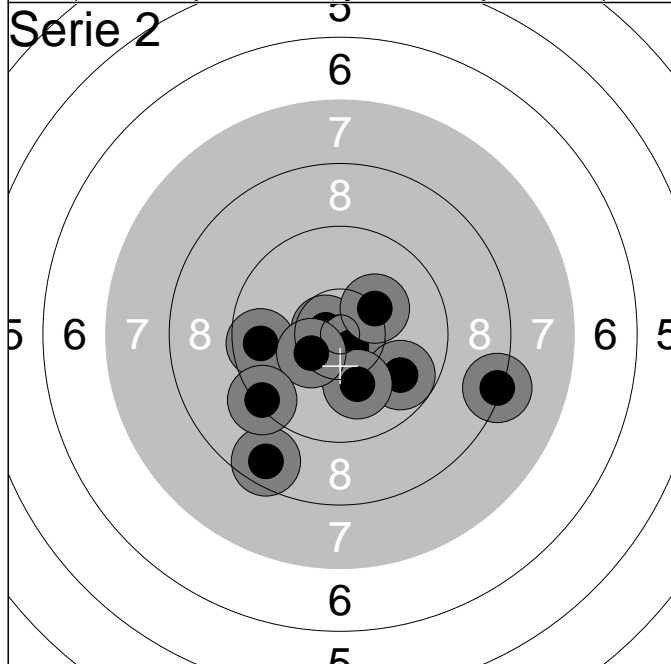

1:	10.7x	↖
2:	10.7x	↘
3:	8.6	↘
4:	8.3	↗
5:	9.7	↖
6:	9.8	↘
7:	10.1	↘
8:	10.4x	↖
9:	9.3	↖
10:	10.3	↗
<b>Serie</b>		<b>93.0</b>
<b>Total</b>		<b>186.0</b>

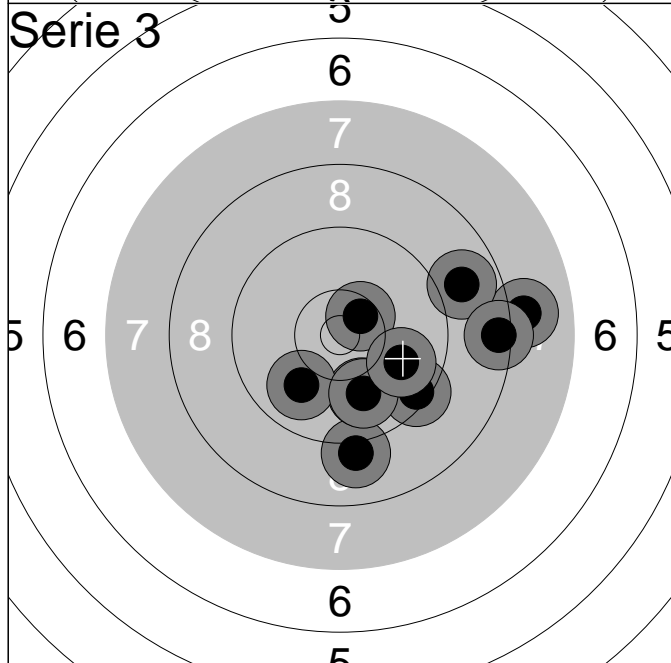

1:	8.0	→
2:	9.1	↘
3:	8.9	→
4:	10.0	↘
5:	9.4	↘
6:	8.4	→
7:	9.9	↖
8:	10.5x	↗
9:	9.9	↘
10:	9.9	↘
<b>Serie</b>		<b>89.0</b>
<b>Total</b>		<b>275.0</b>

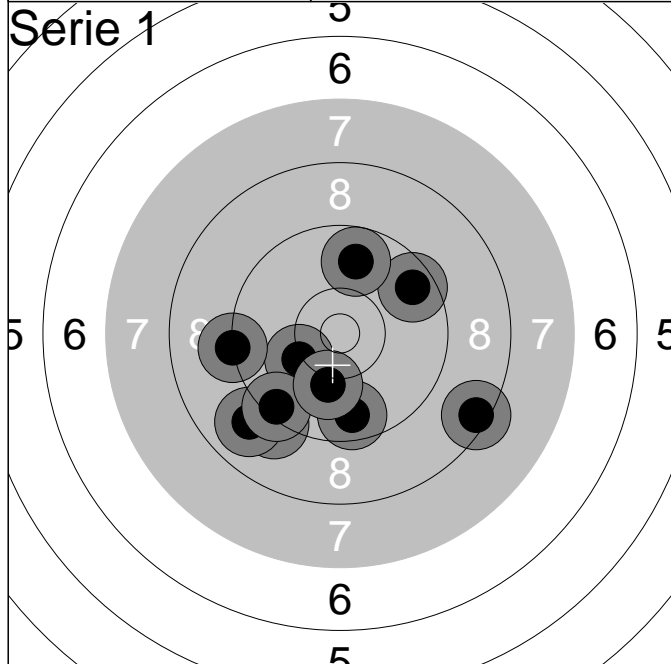

1:	9.6	↗
2:	10.2	↖
3:	9.8	↑
4:	8.4	➔
5:	9.2	↙
6:	8.9	↘
7:	9.4	↙
8:	9.6	↓
9:	10.1	↓
10:	9.2	↖
<b>Serie</b>		<b>90.0</b>
<b>Total</b>		<b>90.0</b>

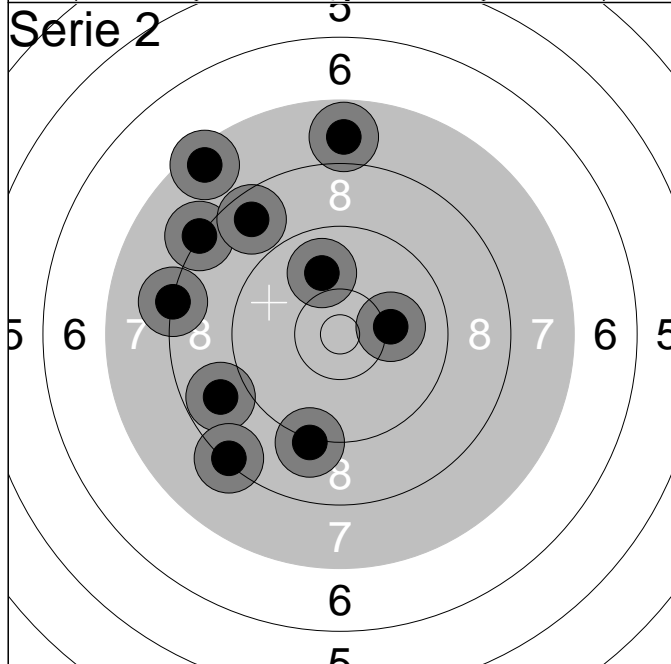

1:	8.2	↗
2:	8.8	↖
3:	8.3	↙
4:	8.6	↗
5:	8.2	↖
6:	9.9	↑
7:	9.2	↓
8:	10.1	➔
9:	7.5	↗
10:	7.8	↑
<b>Serie</b>		<b>82.0</b>
<b>Total</b>		<b>172.0</b>

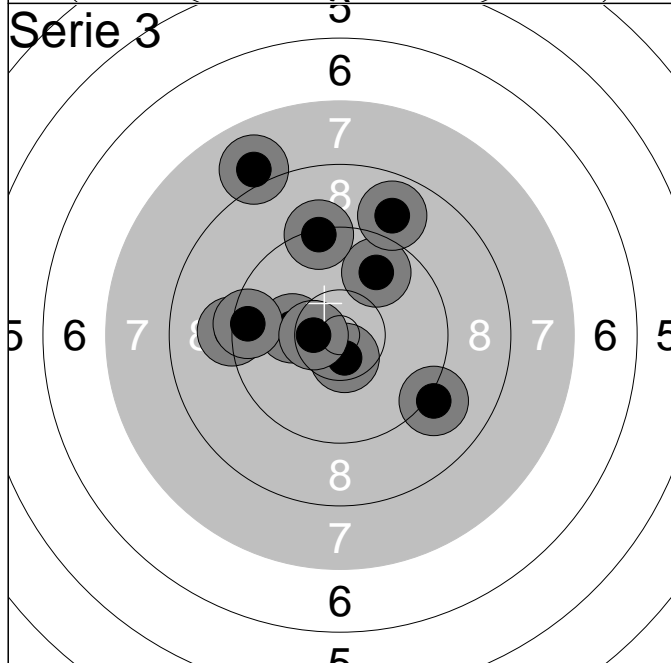

1:	9.8	↗
2:	8.0	↗
3:	10.2	↖
4:	9.2	↖
5:	8.9	↗
6:	9.5	↖
7:	9.1	↘
8:	9.3	↑
9:	10.6x	↓
10:	10.5x	↖
<b>Serie</b>		<b>91.0</b>
<b>Total</b>		<b>263.0</b>

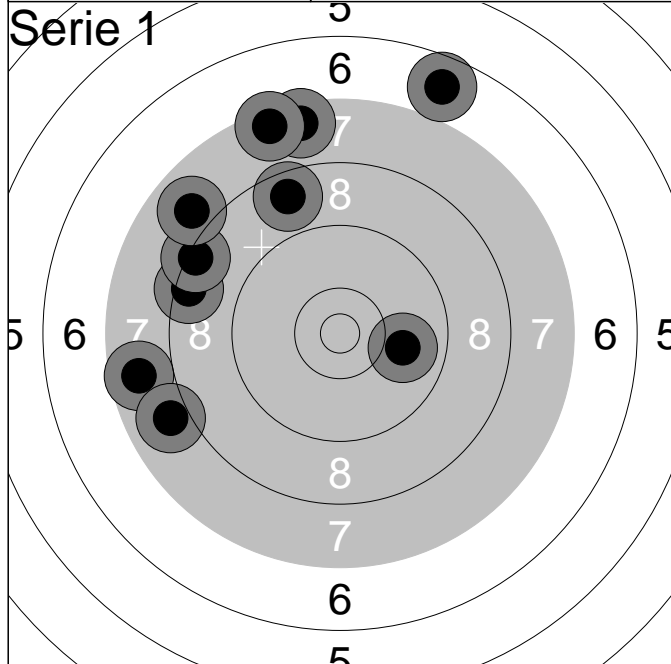

1:	8.6	↗
2:	7.6	↗
3:	7.5	↗
4:	8.4	↖
5:	7.7	↖
6:	9.9	↘
7:	8.3	↗
8:	7.9	↗
9:	7.9	↖
10:	6.7	↗
<b>Serie</b>		<b>74.0</b>
<b>Total</b>		<b>74.0</b>

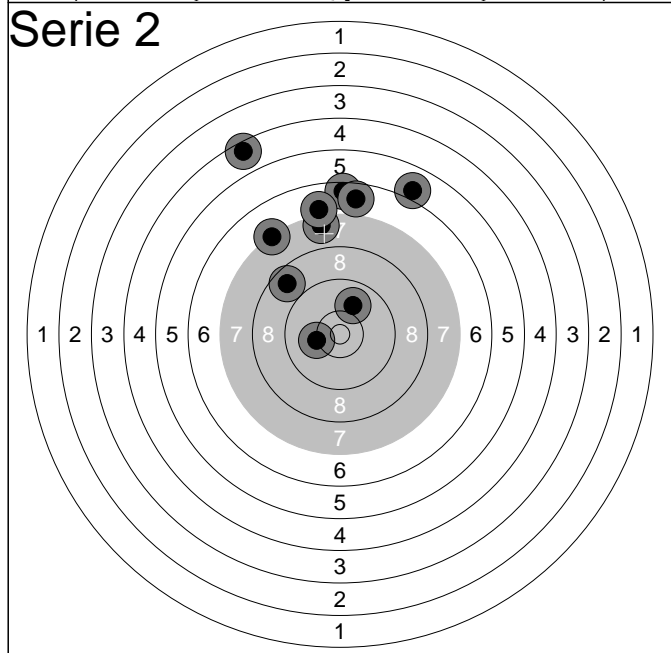

1:	10.2	↖
2:	6.0	↗
3:	6.5	↗
4:	6.7	↗
5:	7.3	↗
6:	4.5	↗
7:	7.5	↗
8:	8.7	↗
9:	7.0	↗
10:	10.0	↗
<b>Serie</b>		<b>71.0</b>
<b>Total</b>		<b>145.0</b>

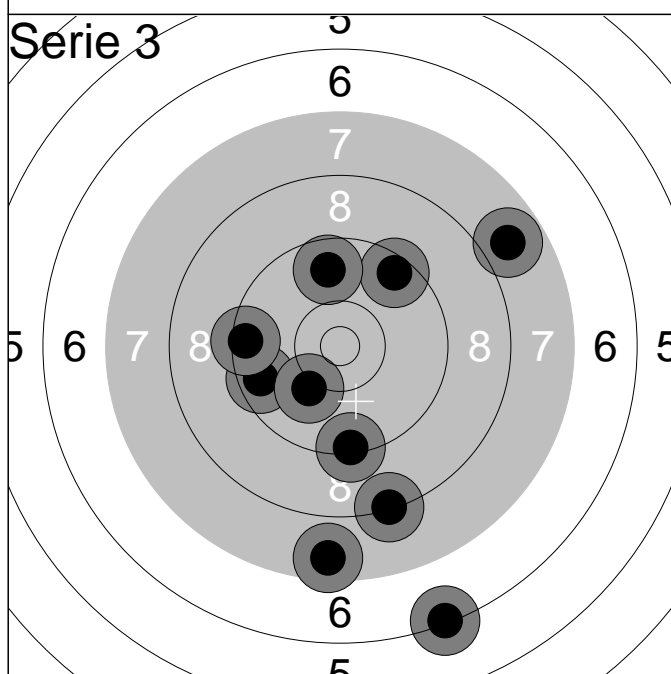

1:	9.5	↗
2:	9.6	↖
3:	9.3	↓
4:	9.4	↖
5:	7.6	↓
6:	7.8	↗
7:	6.3	↓
8:	8.3	↓
9:	10.1	↖
10:	9.7	↗
<b>Serie</b>		<b>83.0</b>
<b>Total</b>		<b>228.0</b>

Lag <b>4</b>	Skive <b>32</b>	<b>Roy G. Johansen</b>	
-----------------	--------------------	------------------------	--

Luft	Mysen Pistollag	P14	
------	-----------------	-----	--

16.04.2015	Landsstevnet rekrutt 2015	LS Rekrutt 2015	
------------	---------------------------	-----------------	--

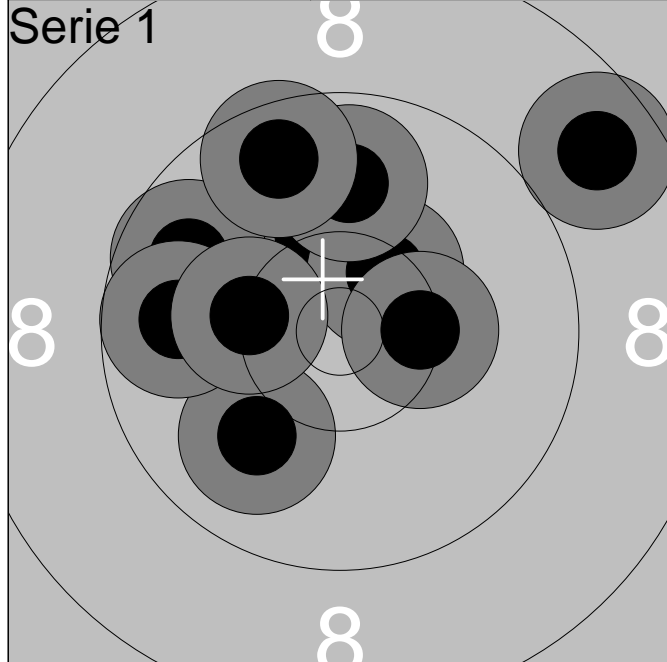

1:	10.0	↙
2:	10.2	↑
3:	9.7	↖
4:	8.7	↗
5:	9.8	←
6:	10.4x	↗
7:	9.9	↑
8:	9.6	↑
9:	10.4x	→
10:	10.3	←
<b>Serie</b>	<b>94.0</b>	
<b>Total</b>	<b>94.0</b>	

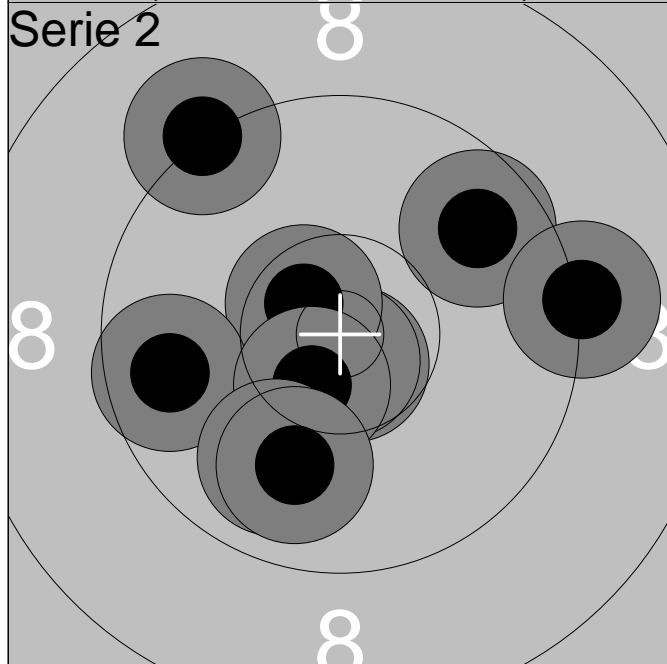

1:	10.7x	↓
2:	10.8x	↓
3:	9.7	↗
4:	9.2	↗
5:	10.6x	↗
6:	9.7	←
7:	10.5x	↙
8:	9.9	↙
9:	9.2	→
10:	10.0	↓
<b>Serie</b>	<b>95.0</b>	
<b>Total</b>	<b>189.0</b>	

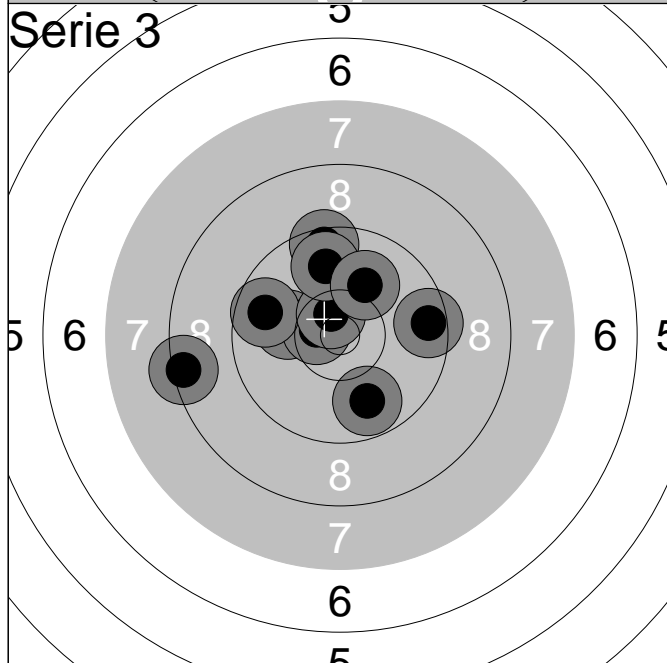

1:	10.1	←
2:	10.6x	←
3:	9.5	↑
4:	9.7	←
5:	10.6x	↗
6:	9.8	↑
7:	8.4	←
8:	9.8	↓
9:	10.1	↗
10:	9.5	→
<b>Serie</b>	<b>93.0</b>	
<b>Total</b>	<b>282.0</b>	

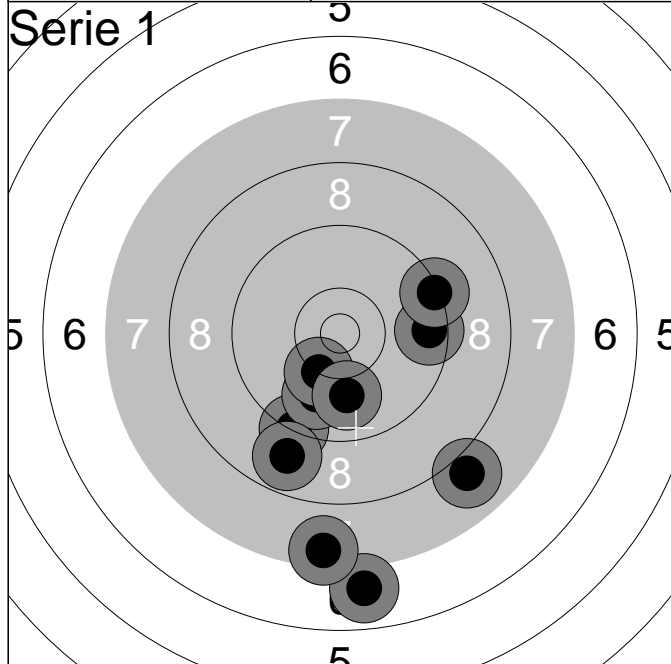

1:	6.9	↓
2:	9.3	↓
3:	9.9	↓
4:	9.5	→
5:	7.5	↓
6:	10.2	↓
7:	9.3	→
8:	8.8	↓
9:	7.9	↓
10:	9.9	↓
<b>Serie</b>		<b>83.0</b>
<b>Total</b>		<b>83.0</b>

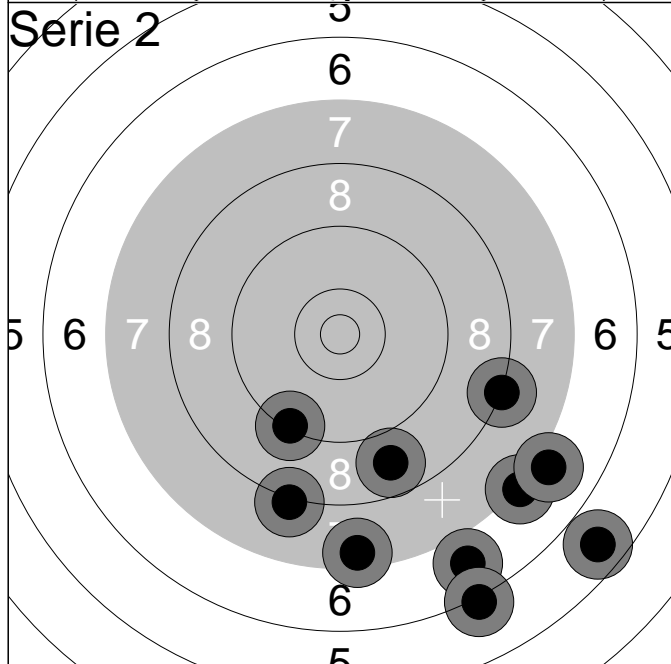

1:	8.8	↓
2:	6.8	↓
3:	8.2	→
4:	6.2	↓
5:	8.2	↓
6:	9.3	↓
7:	7.2	↓
8:	7.5	↓
9:	7.0	↓
10:	5.7	↓
<b>Serie</b>		<b>71.0</b>
<b>Total</b>		<b>154.0</b>

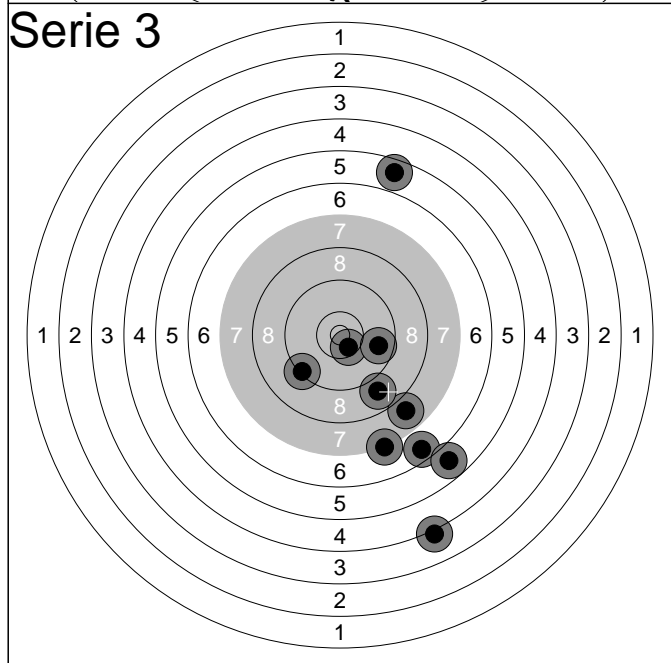

1:	7.2	↓
2:	6.6	↓
3:	10.5x	↓
4:	7.8	↓
5:	9.7	→
6:	8.9	↓
7:	4.1	↓
8:	5.8	↓
9:	5.6	↑
10:	9.3	↙
<b>Serie</b>		<b>70.0</b>
<b>Total</b>		<b>224.0</b>

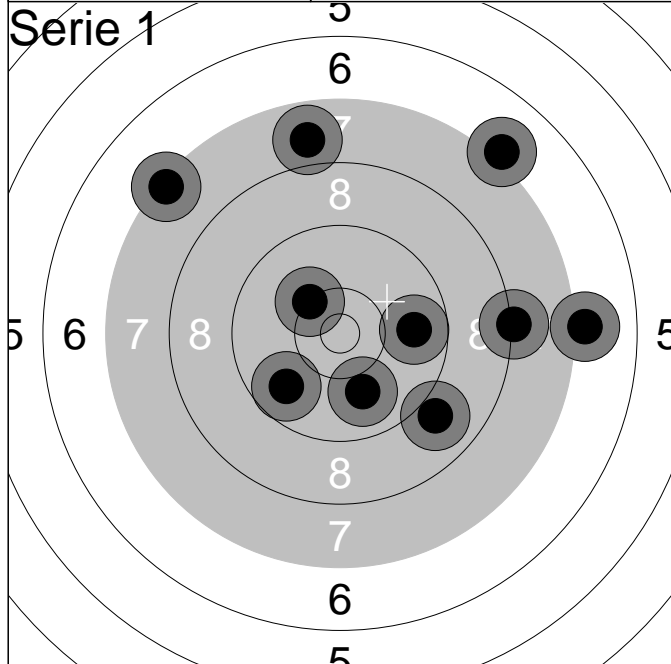

1:	7.3	↗
2:	9.9	↓
3:	7.1	→
4:	9.7	↙
5:	8.9	↘
6:	7.1	↗
7:	9.8	→
8:	10.3	↗
9:	8.2	→
10:	7.8	↑

Serie	81.0
Total	81.0

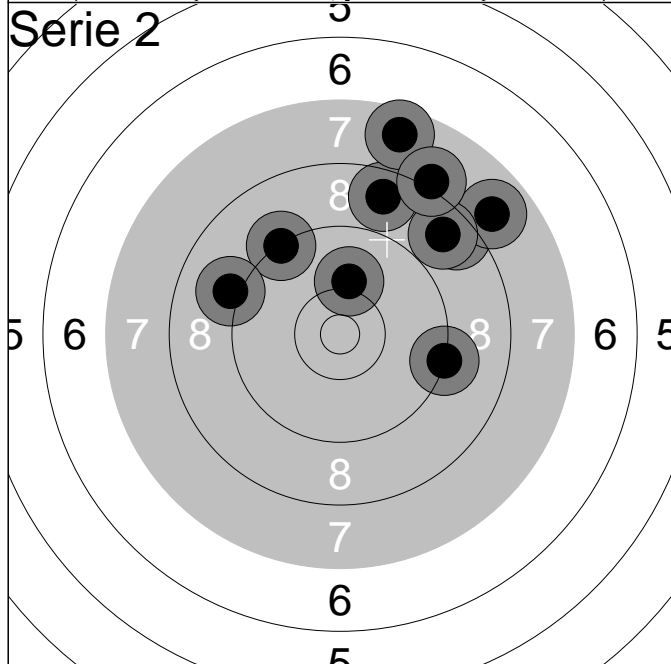

1:	8.5	↗
2:	9.3	↗
3:	9.2	→
4:	8.6	↑
5:	7.6	↑
6:	7.9	↗
7:	10.1	↑
8:	8.7	↗
9:	9.1	↙
10:	8.1	↗

Serie	83.0
Total	164.0

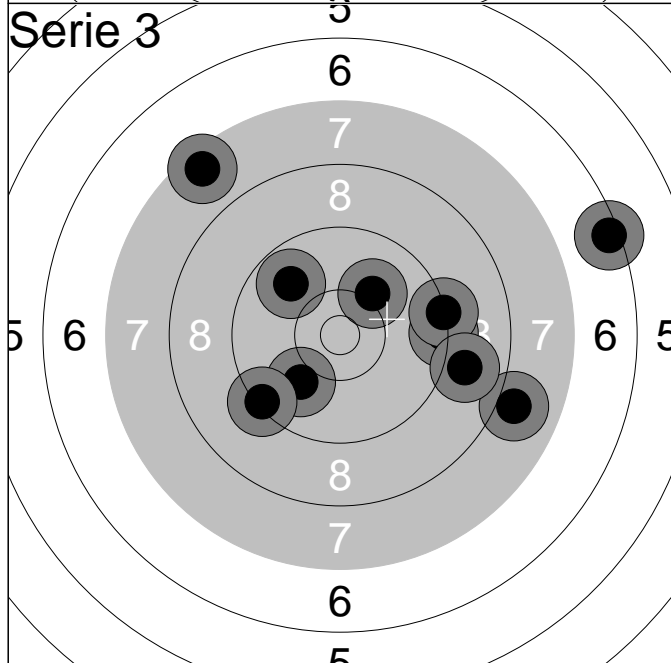

1:	10.1	↗
2:	9.3	→
3:	10.0	↙
4:	7.5	↗
5:	9.8	↗
6:	8.0	↘
7:	6.4	→
8:	9.3	→
9:	9.3	↙
10:	8.9	→

Serie	85.0
Total	249.0



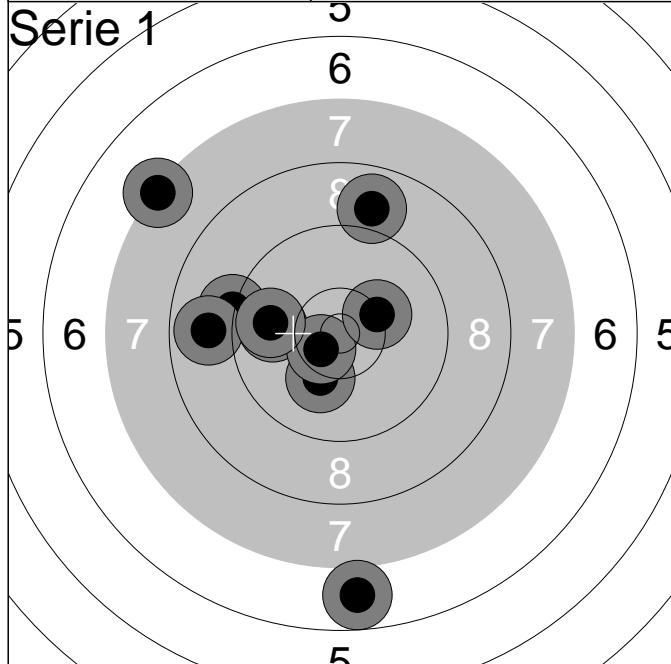

1:	9.9	←
2:	9.2	←
3:	7.3	↗
4:	6.8	↓
5:	8.9	↑
6:	10.2	↓
7:	10.6x	↙
8:	8.9	←
9:	9.8	←
10:	10.3	↗
<b>Serie</b>		<b>86.0</b>
<b>Total</b>		<b>86.0</b>

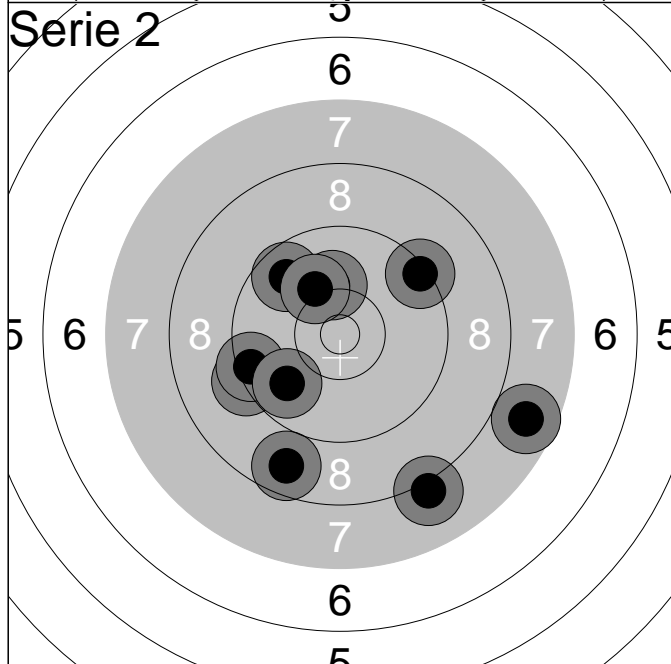

1:	9.3	↗
2:	9.3	←
3:	8.1	↓
4:	10.2	↑
5:	9.4	←
6:	9.7	↗
7:	8.7	↓
8:	9.8	↙
9:	10.1	↑
10:	7.7	↘
<b>Serie</b>		<b>88.0</b>
<b>Total</b>		<b>174.0</b>

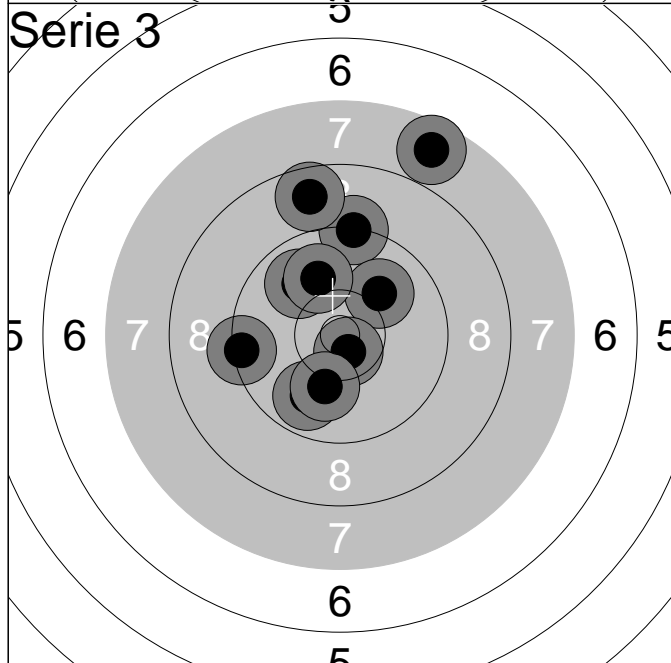

1:	9.3	↑
2:	8.7	↑
3:	9.8	↓
4:	10.0	↗
5:	9.9	↗
6:	7.7	↗
7:	10.0	↑
8:	10.6x	↓
9:	10.1	↓
10:	9.4	←
<b>Serie</b>		<b>91.0</b>
<b>Total</b>		<b>265.0</b>

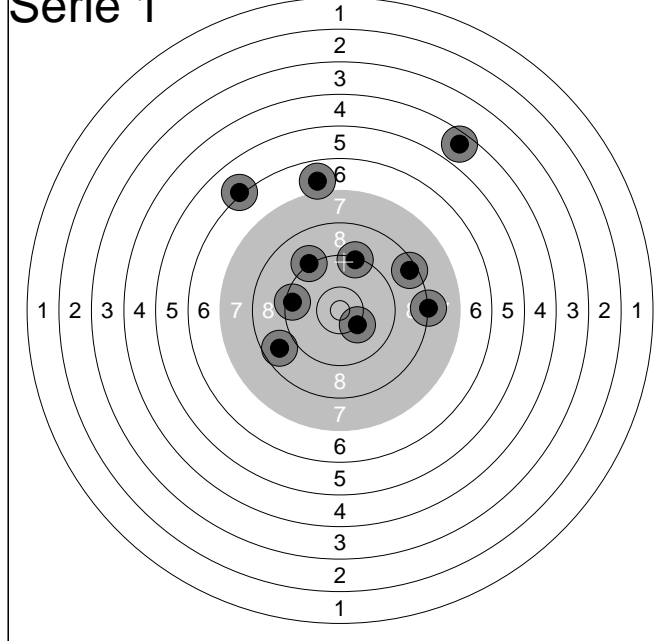

1:	8.7	↙
2:	4.6	↗
3:	9.3	↗
4:	9.4	↙
5:	8.5	↗
6:	9.2	↗
7:	10.2	↘
8:	8.2	→
9:	6.1	↗
10:	6.9	↑
<b>Serie</b>		<b>77.0</b>
<b>Total</b>		<b>77.0</b>

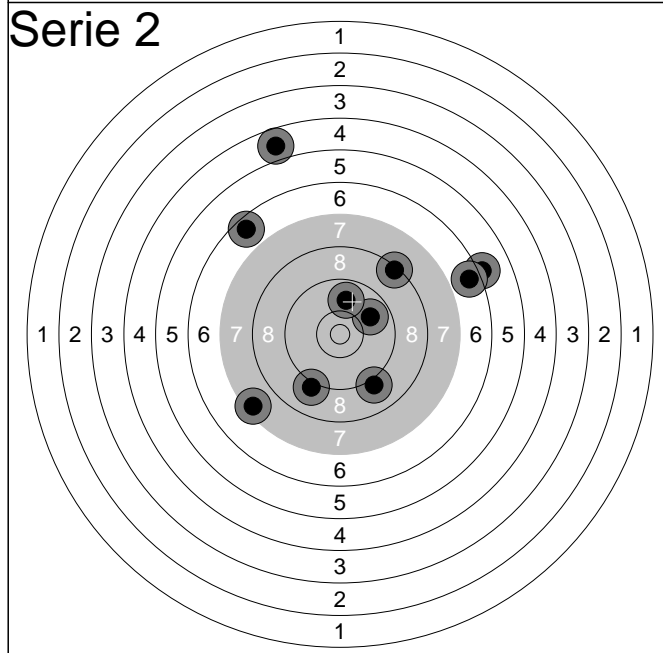

1:	4.8	↖
2:	6.6	↖
3:	9.9	↗
4:	6.1	↗
5:	9.1	↘
6:	9.9	↑
7:	9.0	↘
8:	6.6	↗
9:	7.4	↙
10:	8.3	↗
<b>Serie</b>		<b>73.0</b>
<b>Total</b>		<b>150.0</b>

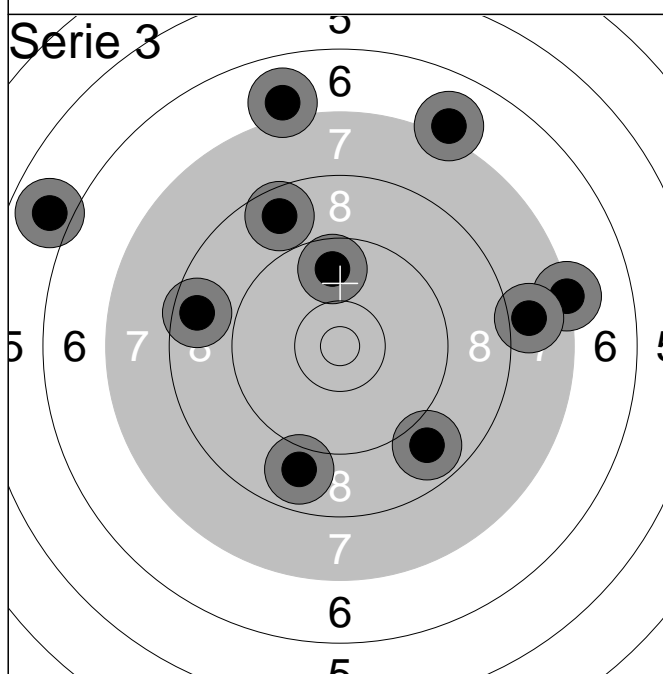

1:	5.9	↙
2:	8.9	↘
3:	7.0	↗
4:	8.6	↙
5:	7.0	↑
6:	8.8	↘
7:	9.7	↑
8:	7.3	→
9:	8.7	↗
10:	7.9	→
<b>Serie</b>		<b>74.0</b>
<b>Total</b>		<b>224.0</b>

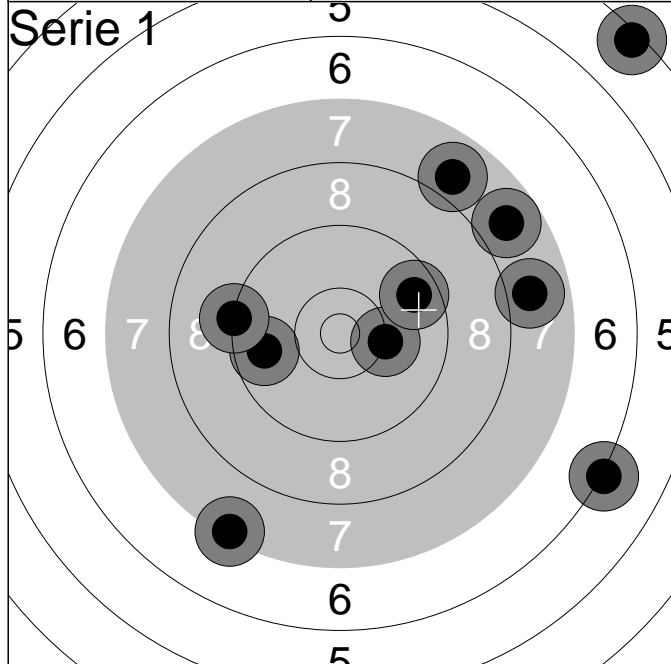

1:	6.2	→
2:	9.7	←
3:	10.2	→
4:	7.8	↗
5:	7.9	→
6:	4.4	↗
7:	7.3	↘
8:	9.6	↗
9:	7.9	↗
10:	9.2	←
<b>Serie</b>		<b>75.0</b>
<b>Total</b>		<b>75.0</b>

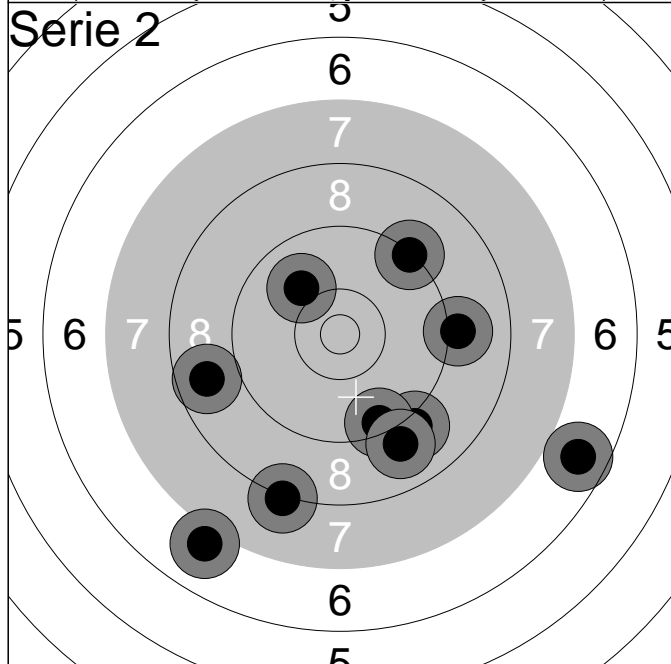

1:	7.0	↘
2:	8.7	←
3:	9.1	↘
4:	9.4	↘
5:	9.1	→
6:	9.3	↗
7:	6.7	→
8:	10.0	↗
9:	9.0	↘
10:	8.2	↘
<b>Serie</b>		<b>84.0</b>
<b>Total</b>		<b>159.0</b>

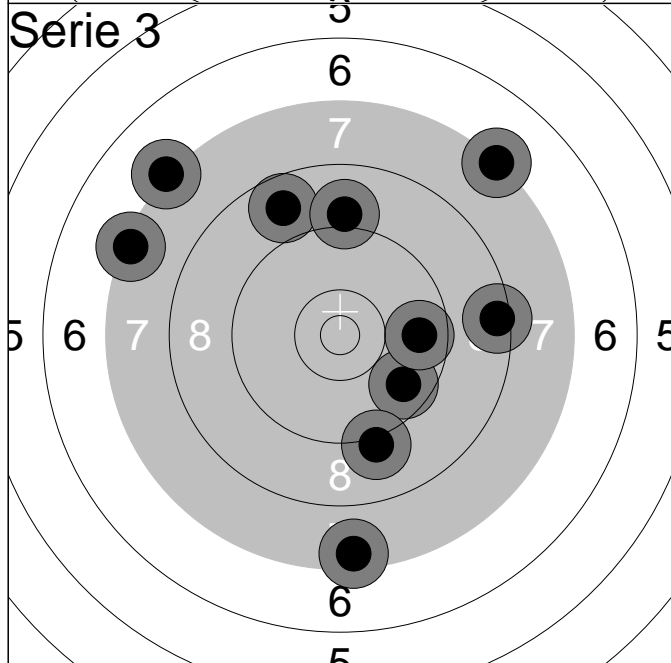

1:	8.7	↗
2:	9.7	↘
3:	7.3	←
4:	7.2	↗
5:	7.2	↗
6:	9.0	↑
7:	9.1	↘
8:	9.7	→
9:	8.4	→
10:	7.5	↘
<b>Serie</b>		<b>80.0</b>
<b>Total</b>		<b>239.0</b>

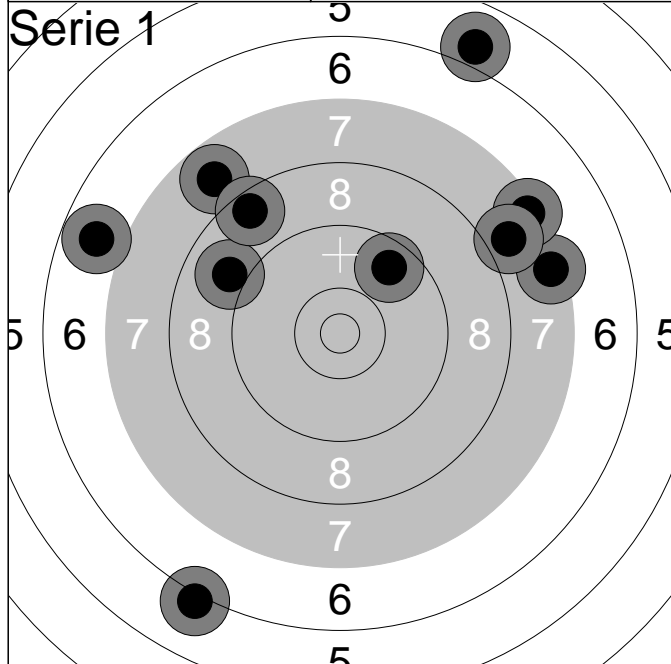

1:	9.6	↗
2:	9.0	↖
3:	7.4	→
4:	6.8	↖
5:	7.8	↗
6:	7.4	↗
7:	6.1	↘
8:	8.5	↗
9:	5.9	↗
10:	7.9	↗

Serie		71.0
Total		71.0

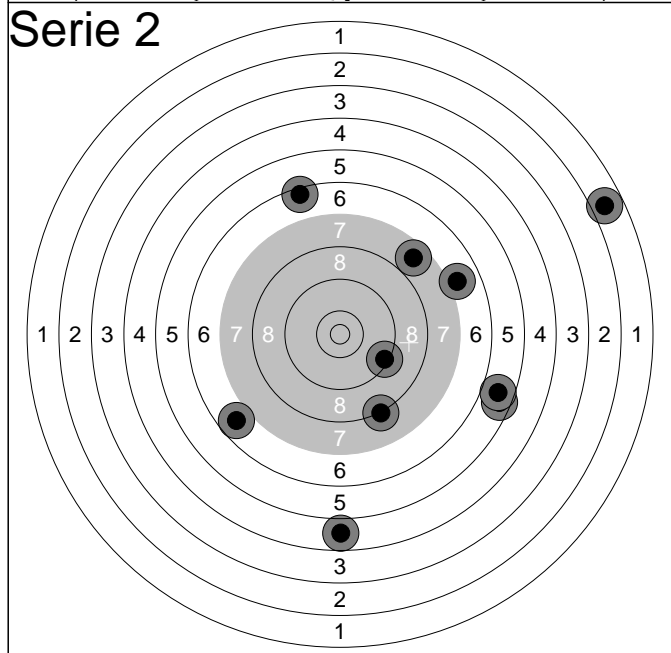

1:	4.8	↓
2:	5.6	→
3:	6.4	↗
4:	6.8	↖
5:	7.6	↗
6:	9.4	↘
7:	8.2	↓
8:	5.7	→
9:	7.0	↗
10:	1.8	↗

Serie		58.0
Total		129.0

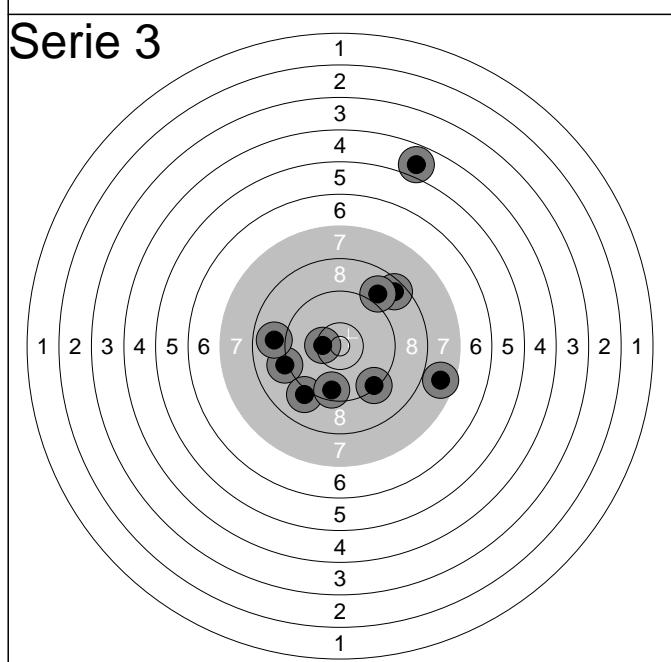

1:	10.4x	←
2:	9.3	↘
3:	9.1	←
4:	4.8	↗
5:	7.6	→
6:	9.1	↖
7:	8.5	↗
8:	9.0	↗
9:	8.9	←
10:	9.6	↓

Serie		82.0
Total		211.0

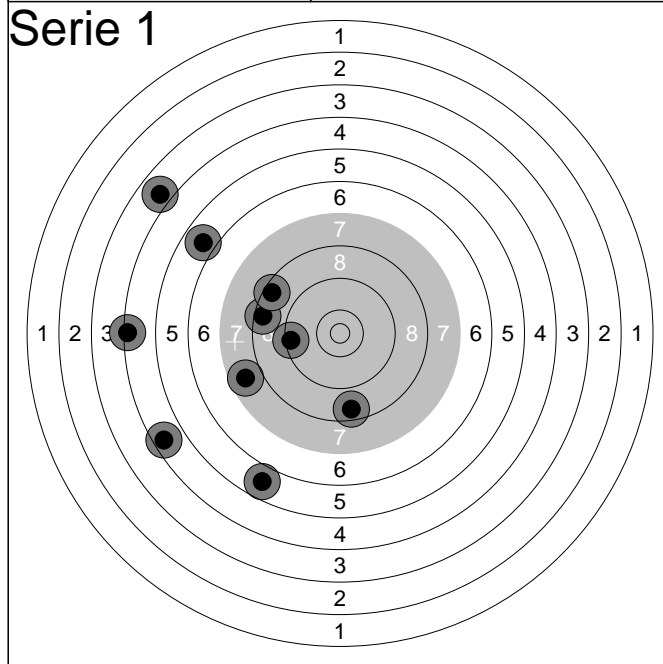

1:	7.7	←
2:	4.3	←
3:	4.5	↙
4:	9.4	←
5:	8.5	←
6:	3.9	↗
7:	8.6	↓
8:	5.8	↓
9:	5.9	↗
10:	8.5	↗
<b>Serie</b>		<b>61.0</b>
<b>Total</b>		<b>61.0</b>

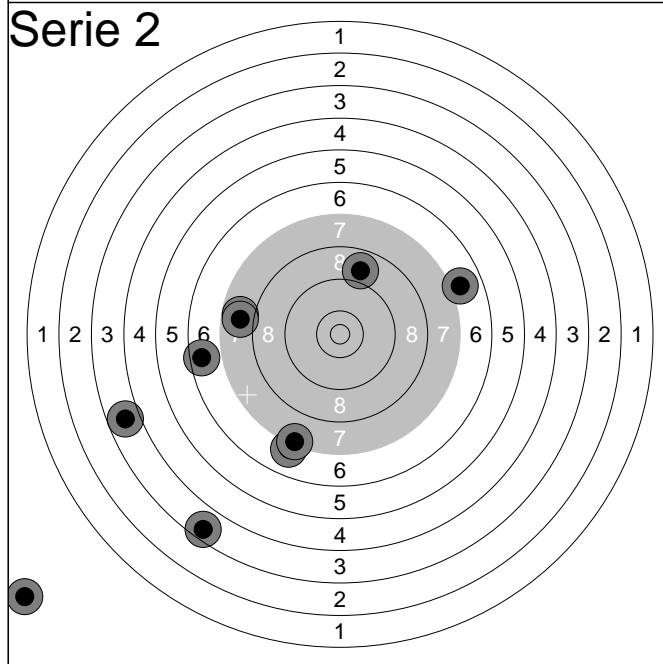

1:	3.8	←
2:	7.0	↓
3:	7.3	↓
4:	6.6	←
5:	7.8	←
6:	0.0	↙
7:	6.9	→
8:	3.6	↙
9:	8.9	↑
10:	7.8	←
<b>Serie</b>		<b>54.0</b>
<b>Total</b>		<b>115.0</b>

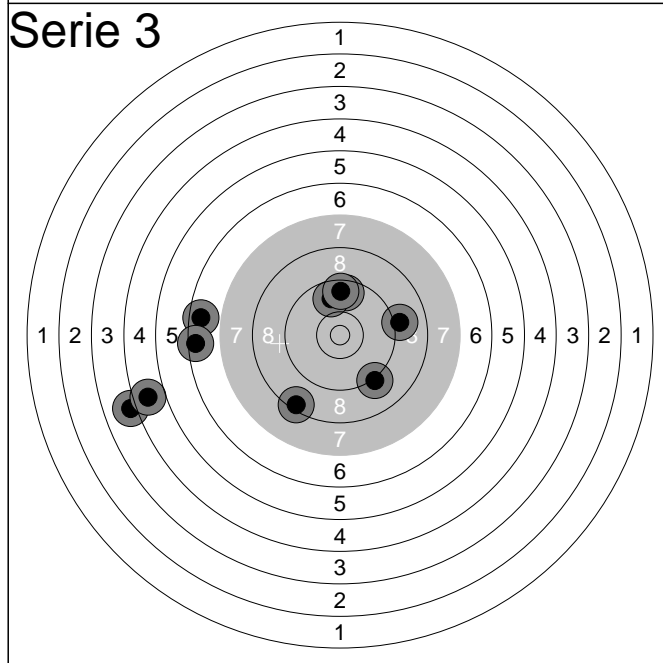

1:	9.6	↑
2:	9.8	↑
3:	6.6	←
4:	8.4	↙
5:	6.5	←
6:	4.1	←
7:	9.2	↓
8:	4.7	←
9:	9.1	→
10:	9.6	↑
<b>Serie</b>		<b>73.0</b>
<b>Total</b>		<b>188.0</b>

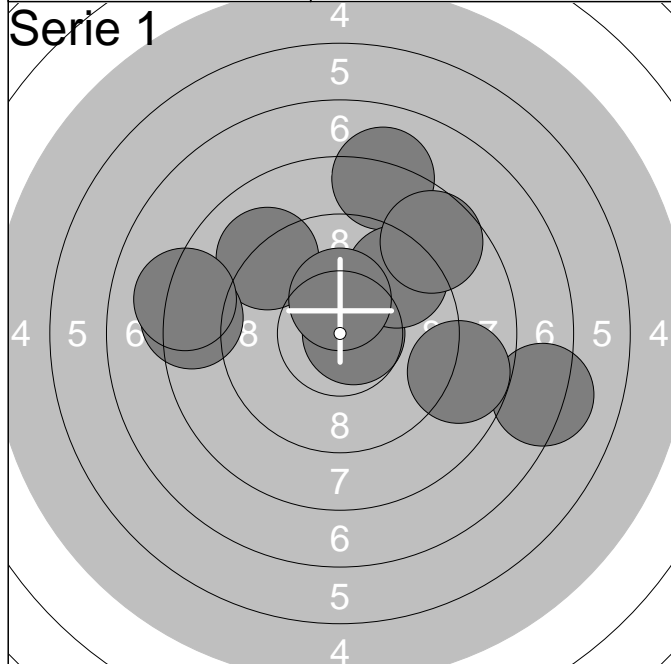

1:	7.2	→
2:	8.1	↑
3:	9.1	↗
4:	10.7x	→
5:	9.5	↗
6:	8.3	←
7:	10.3x	↑
8:	8.6	↗
9:	8.2	←
10:	8.7	→
<b>Serie</b>		<b>85.0</b>
<b>Total</b>		<b>85.0</b>

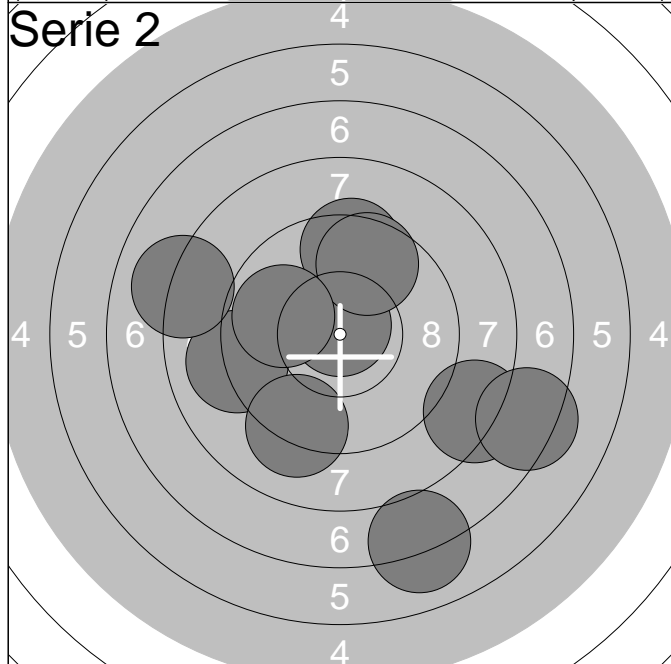

1:	10.8x	↑
2:	9.4	↑
3:	9.6	↗
4:	9.1	←
5:	7.0	↓
6:	8.2	↘
7:	7.3	→
8:	9.2	↓
9:	8.1	←
10:	9.9	←
<b>Serie</b>		<b>85.0</b>
<b>Total</b>		<b>170.0</b>

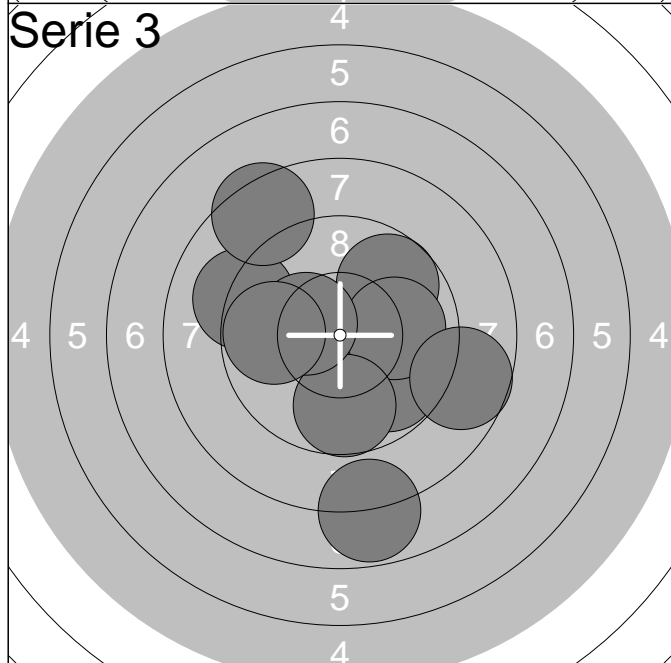

1:	9.1	←
2:	7.8	↓
3:	9.8	↘
4:	9.7	↗
5:	8.4	↗
6:	10.0	→
7:	9.7	↓
8:	10.3x	←
9:	8.7	→
10:	9.8	←
<b>Serie</b>		<b>88.0</b>
<b>Total</b>		<b>258.0</b>

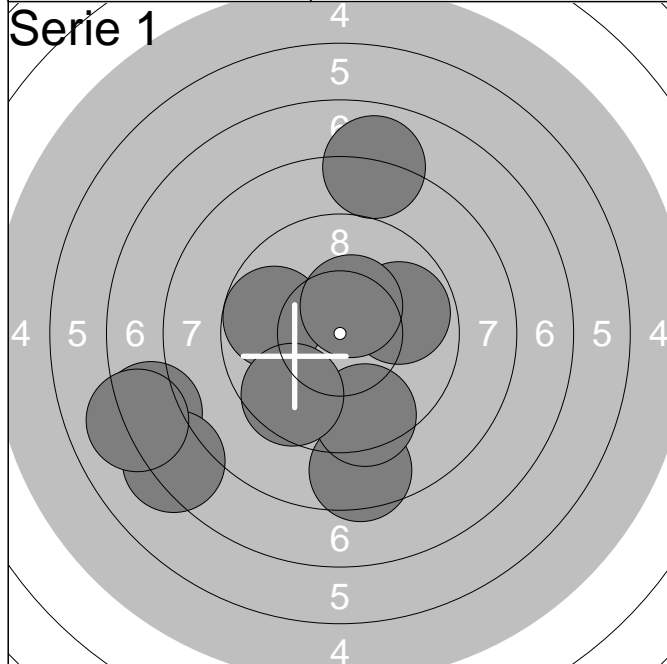

1:	8.0	↑
2:	7.3	↙
3:	7.2	↙
4:	9.7	↙
5:	7.1	↙
6:	8.5	↓
7:	9.4	↓
8:	9.6	↙
9:	9.8	→
10:	10.4x	↑
<b>Serie</b>		<b>83.0</b>
<b>Total</b>		<b>83.0</b>

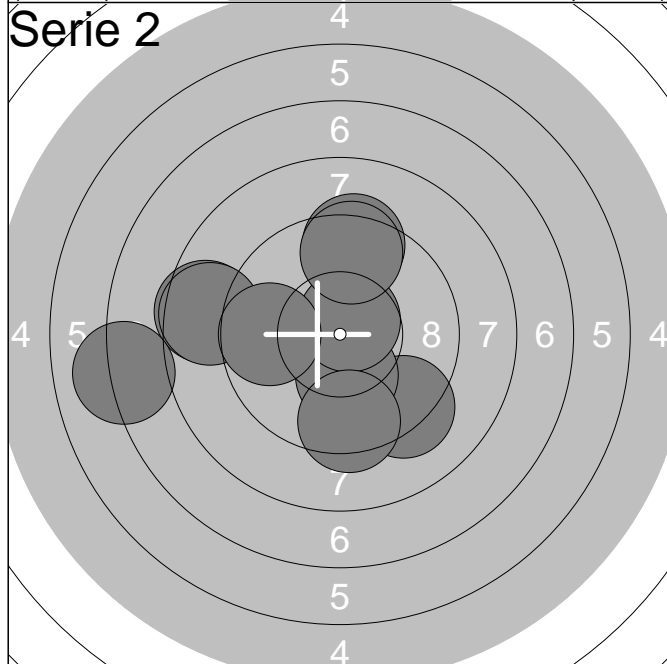

1:	8.6	↙
2:	9.2	↓
3:	10.2x	↓
4:	9.4	↑
5:	10.7x	↗
6:	8.6	↙
7:	7.1	↙
8:	9.5	↑
9:	9.7	↙
10:	9.4	↓
<b>Serie</b>		<b>88.0</b>
<b>Total</b>		<b>171.0</b>



1:	10.3x	↙
2:	8.7	↘
3:	5.2	↙
4:	10.6x	↑
5:	8.7	↙
6:	9.3	↘
7:	10.7x	↗
8:	9.6	↙
9:	10.3x	↓
10:	9.6	↙
<b>Serie</b>		<b>88.0</b>
<b>Total</b>		<b>259.0</b>

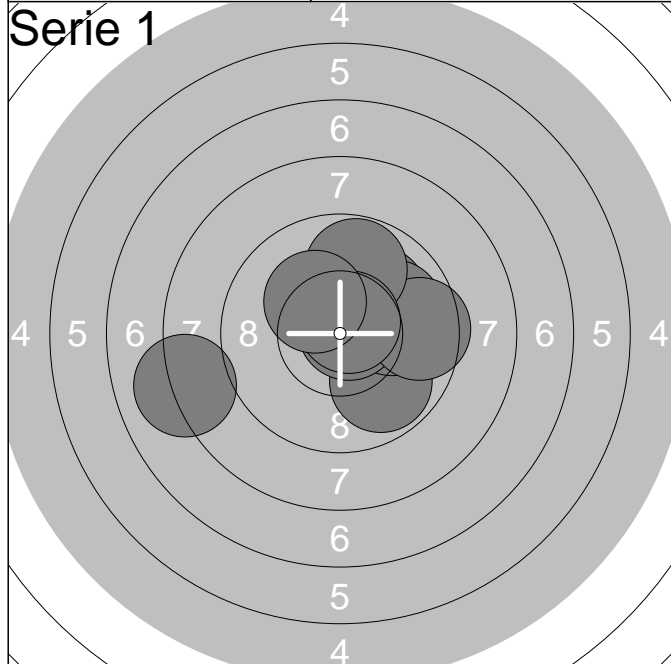

1:	9.8	↘
2:	10.0	→
3:	10.0	↗
4:	9.9	→
5:	10.8x	↗
6:	9.5	→
7:	9.8	↑
8:	8.1	←
9:	10.7x	↗
10:	10.2x	↖
<b>Serie</b>		<b>94.0</b>
<b>Total</b>		<b>94.0</b>

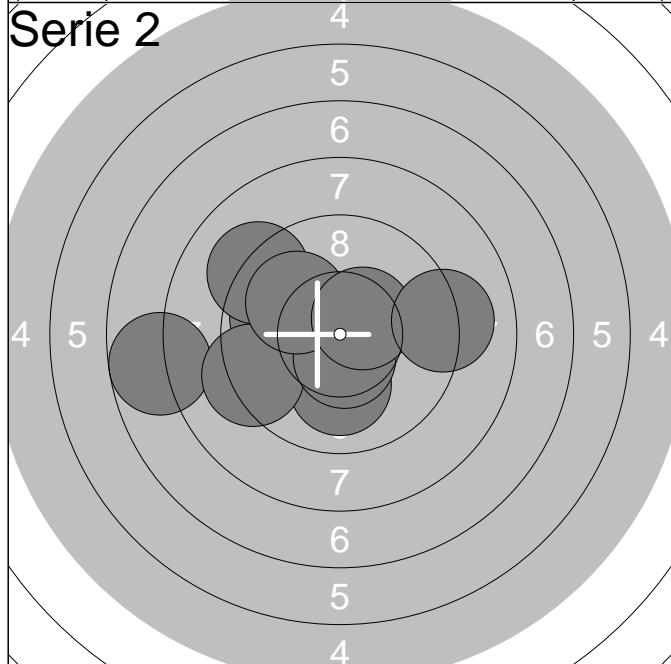

1:	9.9	←
2:	10.1	↓
3:	7.7	←
4:	10.8x	↗
5:	9.3	←
6:	10.5x	↓
7:	9.1	↗
8:	10.0	↗
9:	10.4x	↗
10:	9.1	→
<b>Serie</b>		<b>93.0</b>
<b>Total</b>		<b>187.0</b>

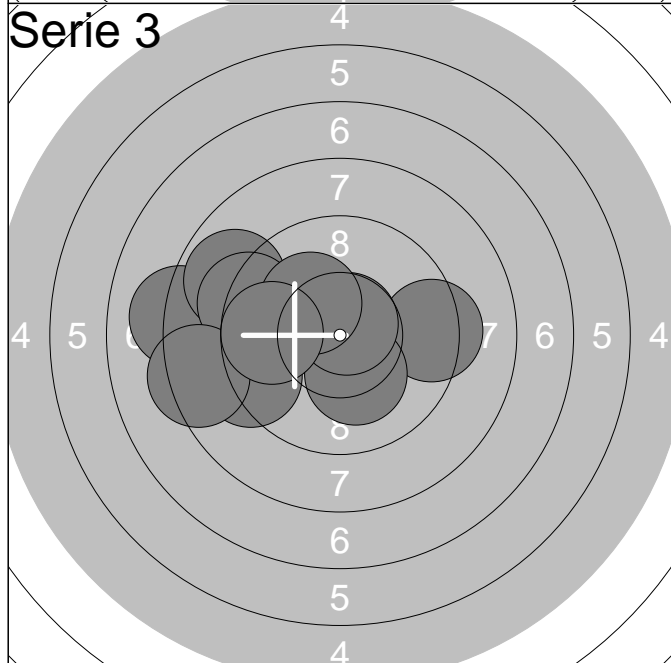

1:	9.3	→
2:	9.2	←
3:	8.1	←
4:	10.2x	↓
5:	8.9	↗
6:	10.7x	↗
7:	9.2	←
8:	8.3	←
9:	10.1	↗
10:	9.7	←
<b>Serie</b>		<b>90.0</b>
<b>Total</b>		<b>277.0</b>



Lag <b>5</b>	Skive <b>4</b>	<b>Linn Bentengen</b>		
-----------------	-------------------	-----------------------	--	--

Luft	Eidskog Sportsskyttere	R15/16	
------	------------------------	--------	--

16.04.2015	Landsstevnet rekrutt 2015	LS Rekrutt 2015	
------------	---------------------------	-----------------	--

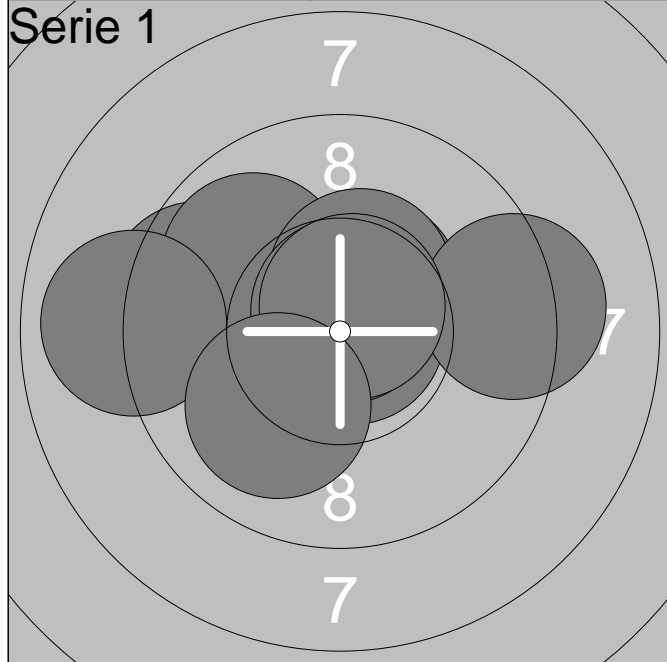

1:	9.5	←
2:	10.4x	↗
3:	10.8x	→
4:	9.9	↖
5:	10.4x	↗
6:	9.3	→
7:	10.7x	↑
8:	10.7x	↗
9:	8.9	←
10:	10.0	↙
<b>Serie</b>		<b>95.0</b>
<b>Total</b>		<b>95.0</b>

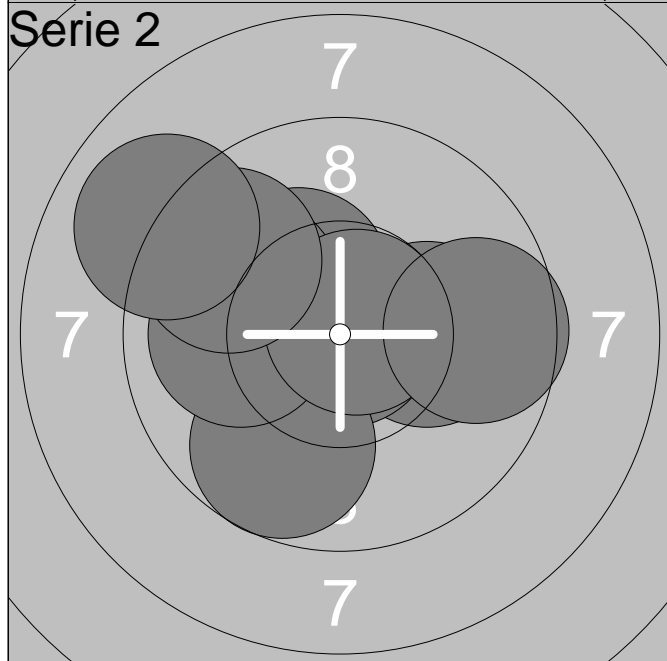

1:	10.1	→
2:	10.3x	↗
3:	10.9x	→
4:	9.9	↖
5:	9.7	↘
6:	10.0	←
7:	10.7x	↗
8:	9.6	↗
9:	8.9	↗
10:	9.6	→
<b>Serie</b>		<b>94.0</b>
<b>Total</b>		<b>189.0</b>

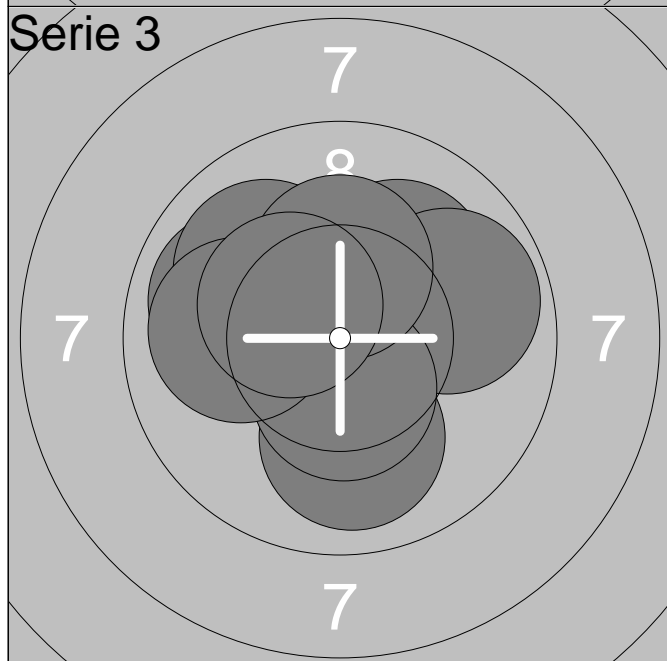

1:	9.9	←
2:	10.1	←
3:	10.0	↓
4:	10.1	↗
5:	9.8	→
6:	10.0	↗
7:	10.4x	↓
8:	10.2x	↑
9:	10.0	←
10:	10.3x	↖
<b>Serie</b>		<b>98.0</b>
<b>Total</b>		<b>287.0</b>

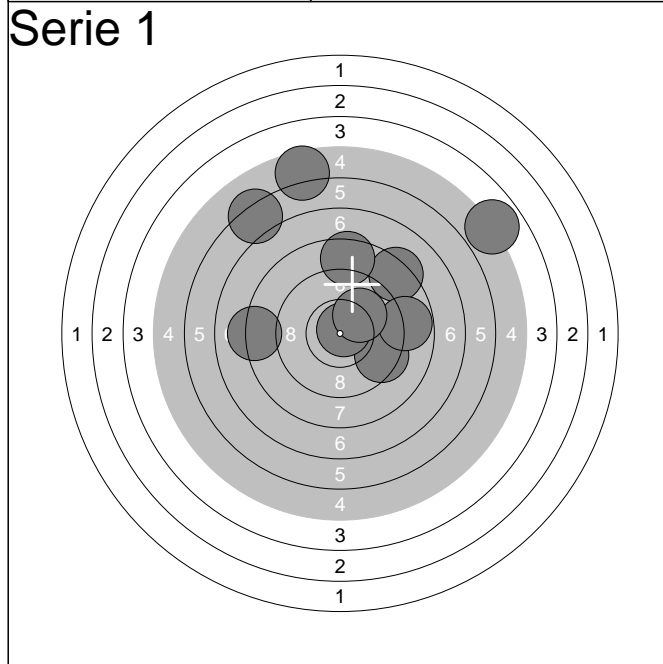

1:	4.9	↗
2:	8.3	↗
3:	5.5	↑
4:	9.4	→
5:	8.5	↑
6:	10.8x	↗
7:	8.1	←
8:	6.2	↗
9:	8.8	→
10:	10.1	↗
<b>Serie</b>		<b>76.0</b>
<b>Total</b>		<b>76.0</b>

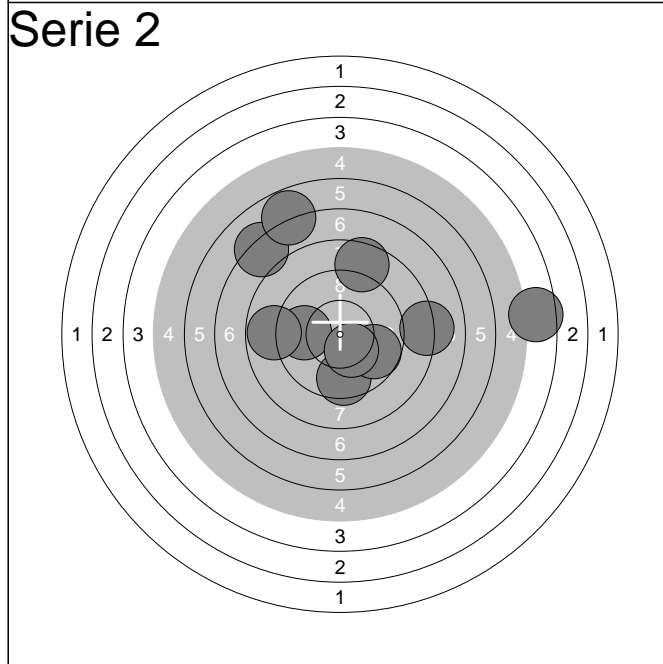

1:	9.8	←
2:	8.5	↑
3:	8.8	←
4:	7.2	↗
5:	9.5	↓
6:	9.7	↘
7:	4.5	→
8:	8.1	→
9:	6.8	↑
10:	10.3x	↓
<b>Serie</b>		<b>78.0</b>
<b>Total</b>		<b>154.0</b>

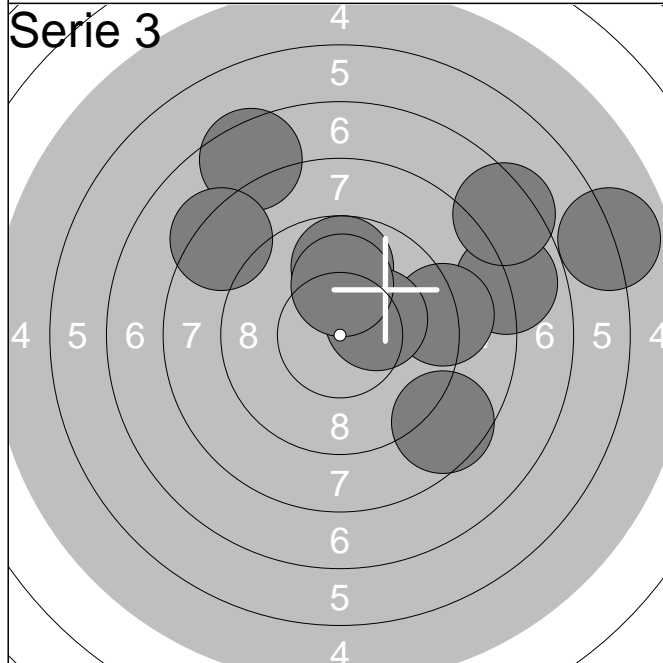

1:	5.9	→
2:	7.9	→
3:	8.6	↘
4:	9.7	↑
5:	7.5	↗
6:	9.1	→
7:	7.3	↗
8:	10.2x	→
9:	10.0	↑
10:	8.3	↖
<b>Serie</b>		<b>80.0</b>
<b>Total</b>		<b>234.0</b>

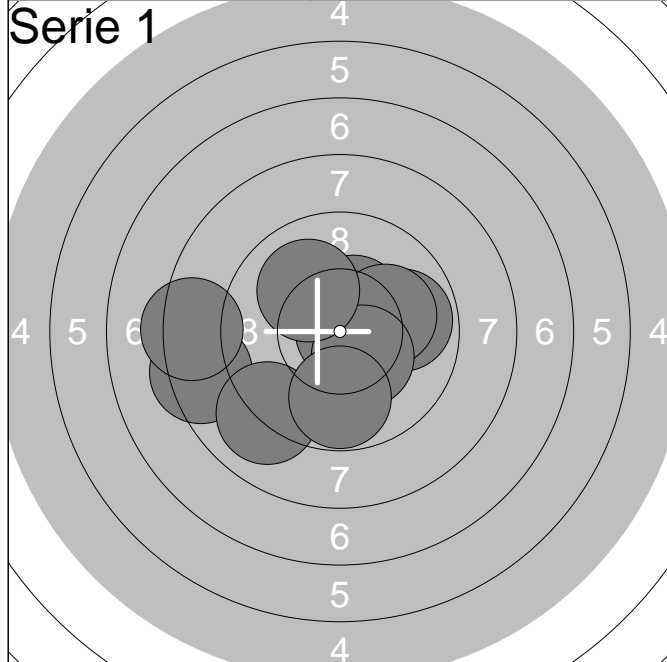

1:	9.8	→
2:	10.4x	↗
3:	8.4	←
4:	10.8x	→
5:	10.1	→
6:	8.3	←
7:	9.0	↙
8:	10.3x	↘
9:	9.8	↓
10:	10.0	↖
<b>Serie</b>		<b>93.0</b>
<b>Total</b>		<b>93.0</b>

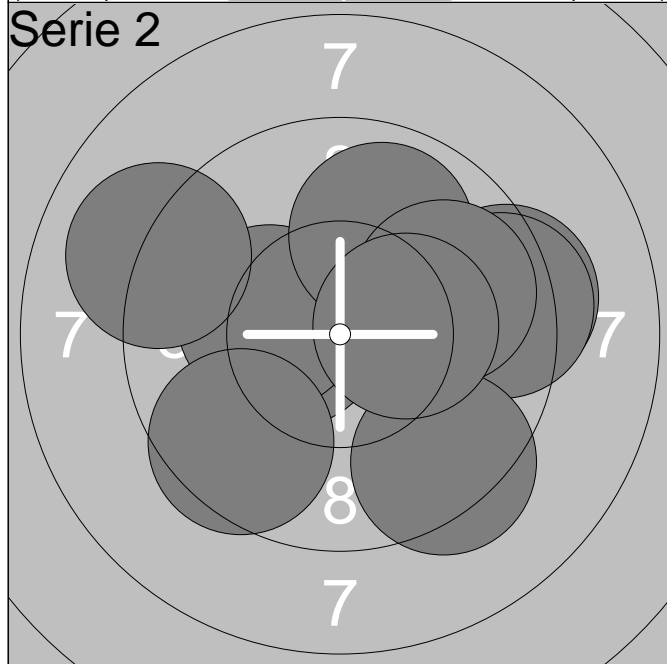

1:	9.3	→
2:	10.5x	←
3:	10.2x	←
4:	9.9	↗
5:	9.3	→
6:	9.9	↗
7:	9.3	↘
8:	9.5	↙
9:	9.0	↖
10:	10.3x	→
<b>Serie</b>		<b>93.0</b>
<b>Total</b>		<b>186.0</b>



1:	10.4x	←
2:	10.6x	→
3:	9.7	↘
4:	10.6x	↑
5:	10.4x	↗
6:	9.6	→
7:	10.3x	←
8:	10.6x	↗
9:	9.2	←
10:	6.8	→
<b>Serie</b>		<b>93.0</b>
<b>Total</b>		<b>279.0</b>

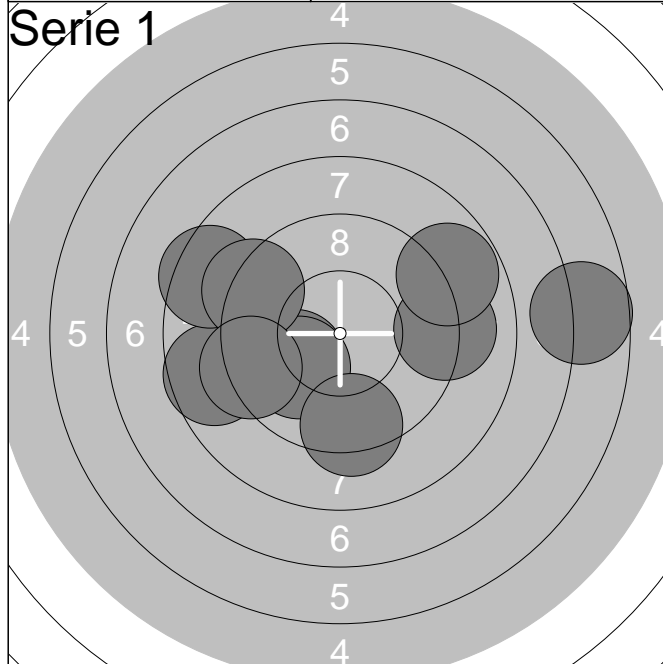

1:	10.0	↙
2:	8.6	↙
3:	10.0	↙
4:	8.5	↗
5:	9.2	↗
6:	9.1	→
7:	8.8	↗
8:	6.7	→
9:	9.3	↓
10:	9.3	↙
<b>Serie</b>		<b>86.0</b>
<b>Total</b>		<b>86.0</b>

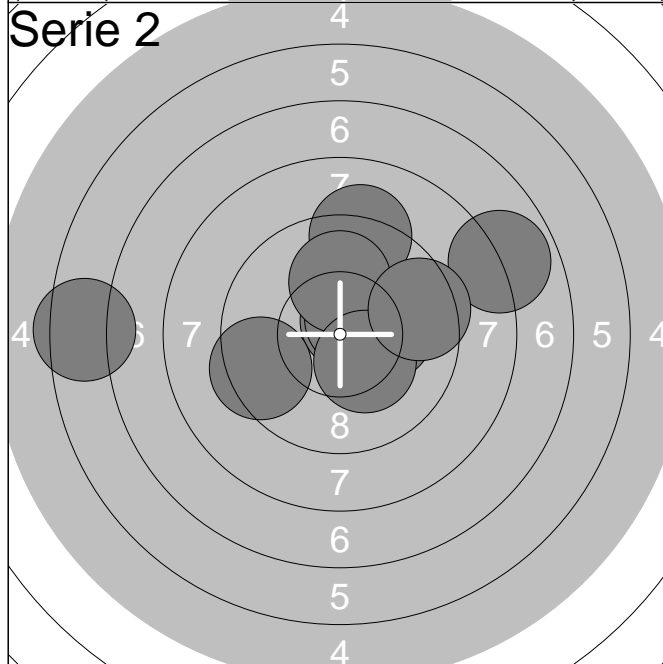

1:	10.6x	↗
2:	9.2	↑
3:	10.2x	→
4:	10.5x	↗
5:	7.9	↗
6:	10.0	↑
7:	6.4	↙
8:	9.4	↙
9:	10.3x	↓
10:	9.5	→
<b>Serie</b>		<b>90.0</b>
<b>Total</b>		<b>176.0</b>

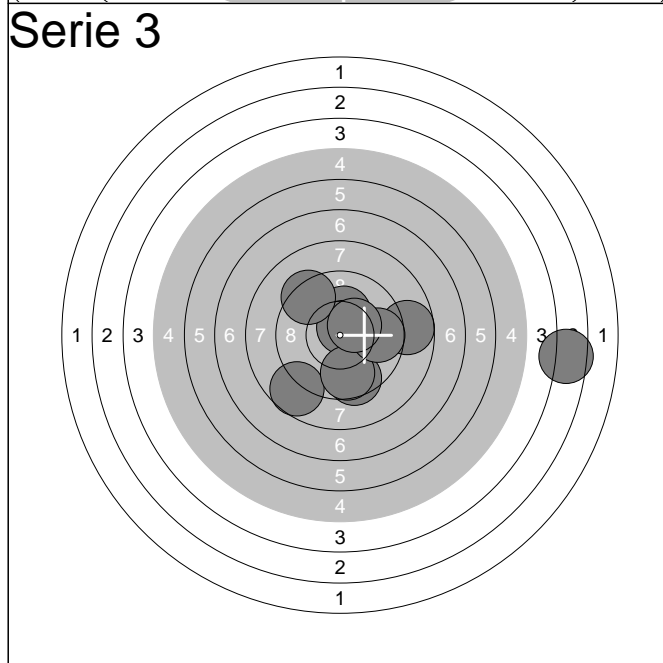

1:	8.7	→
2:	8.7	↙
3:	10.2x	↑
4:	10.6x	↗
5:	9.4	↓
6:	9.3	↗
7:	9.7	↓
8:	9.7	→
9:	10.3x	↗
10:	3.5	→
<b>Serie</b>		<b>85.0</b>
<b>Total</b>		<b>261.0</b>

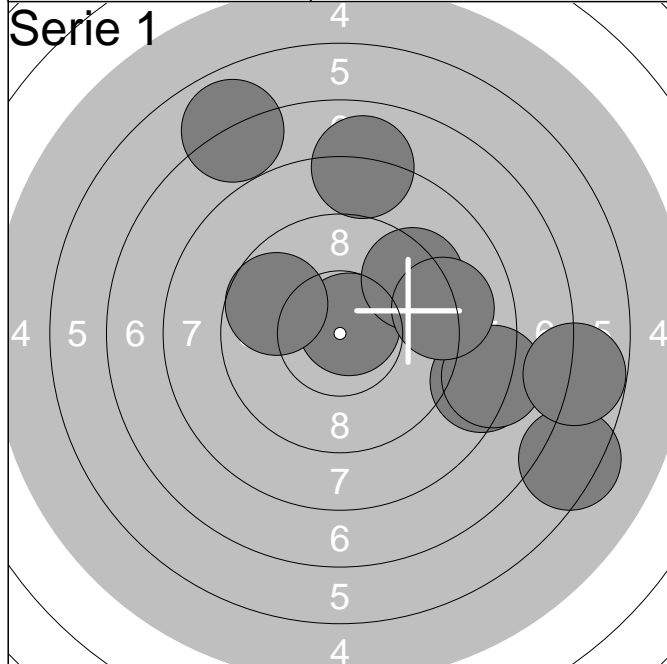

1:	10.7x	↗
2:	9.3	↗
3:	8.3	→
4:	6.3	↘
5:	8.0	↑
6:	9.7	↖
7:	8.2	→
8:	6.8	→
9:	6.9	↗
10:	9.1	→

Serie	<b>79.0</b>
Total	<b>79.0</b>

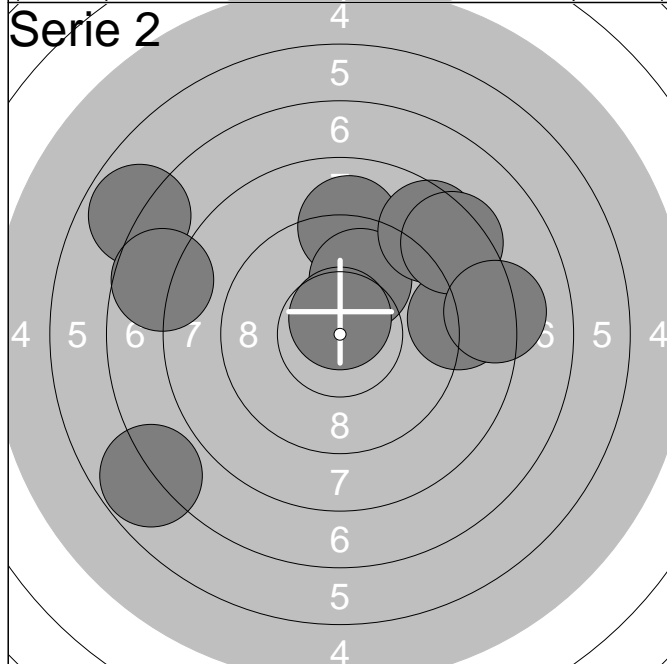

1:	6.8	↖
2:	6.9	↖
3:	9.1	↑
4:	9.9	↑
5:	8.8	→
6:	10.7x	↑
7:	8.5	↗
8:	8.4	↗
9:	8.2	→
10:	7.7	↖

Serie	<b>79.0</b>
Total	<b>158.0</b>



1:	8.4	↖
2:	7.2	↗
3:	9.3	↖
4:	6.8	↘
5:	10.2x	→
6:	5.3	↖
7:	8.5	↑
8:	6.0	↖
9:	6.2	↗
10:	9.2	↗

Serie	<b>74.0</b>
Total	<b>232.0</b>

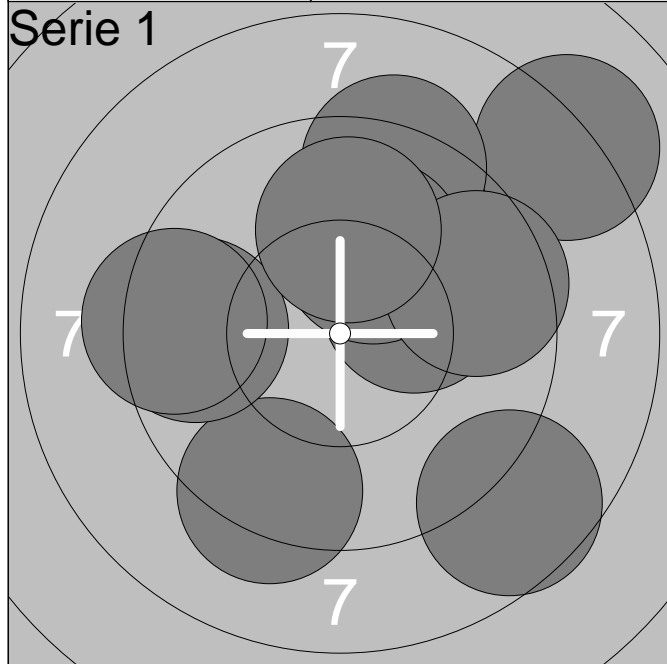

1:	9.3	↙
2:	8.6	↘
3:	8.1	↗
4:	10.1	→
5:	9.2	↑
6:	9.5	←
7:	10.1	↑
8:	9.3	←
9:	9.5	→
10:	9.9	↑
<b>Serie</b>		<b>90.0</b>
<b>Total</b>		<b>90.0</b>

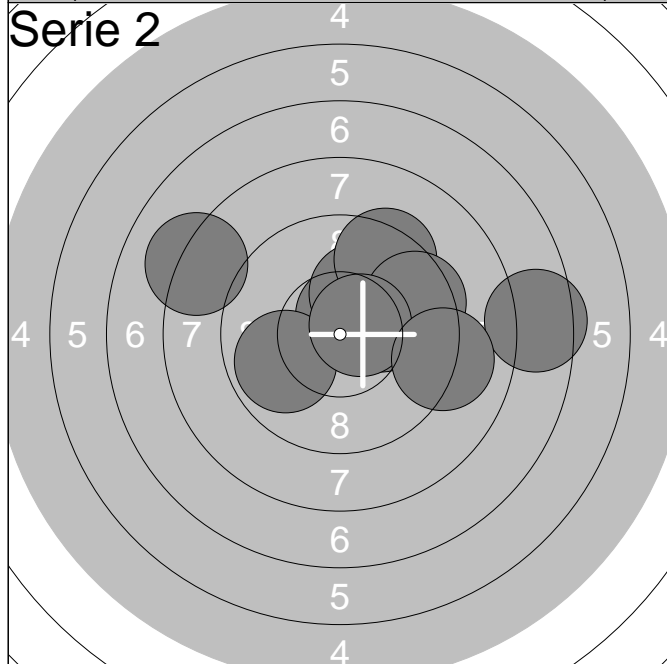

1:	8.1	↖
2:	10.6x	↑
3:	10.1	↑
4:	10.2x	→
5:	9.4	↑
6:	9.8	↖
7:	9.5	→
8:	10.5x	→
9:	7.5	→
10:	9.1	→
<b>Serie</b>		<b>91.0</b>
<b>Total</b>		<b>181.0</b>



1:	9.8	→
2:	8.4	↖
3:	9.1	→
4:	7.0	←
5:	9.2	→
6:	9.4	→
7:	10.4x	→
8:	9.2	→
9:	9.0	↘
10:	8.1	↖
<b>Serie</b>		<b>87.0</b>
<b>Total</b>		<b>268.0</b>

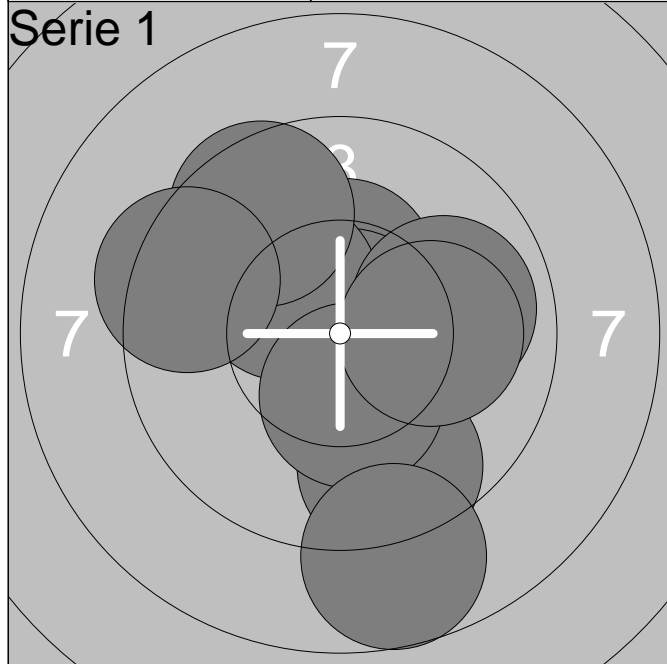

1:	10.3x	↑
2:	10.8x	↗
3:	10.2x	↗
4:	9.9	→
5:	9.6	↗
6:	9.4	↖
7:	9.6	↓
8:	10.3x	↓
9:	10.1	→
10:	8.7	↓
<b>Serie</b>		<b>94.0</b>
<b>Total</b>		<b>94.0</b>

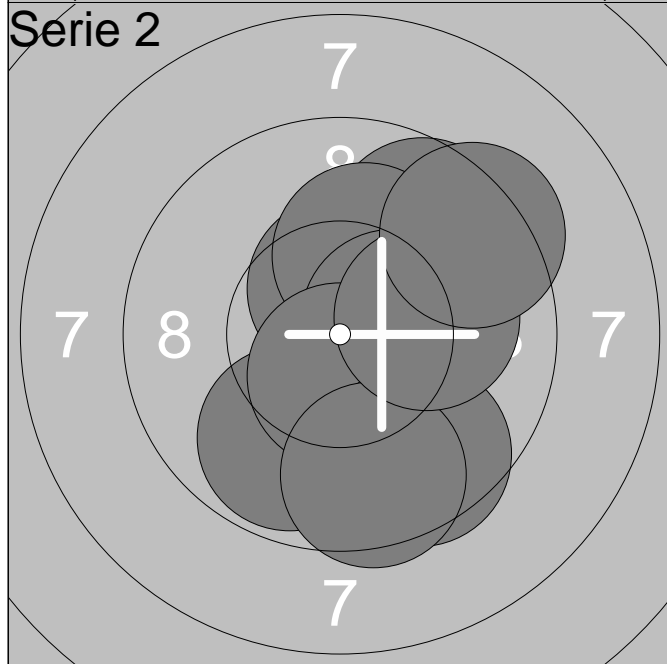

1:	9.7	↗
2:	10.5x	↑
3:	10.1	↑
4:	10.4x	→
5:	9.8	↓
6:	10.5x	↓
7:	9.5	↓
8:	9.5	↓
9:	10.1	→
10:	9.3	↗
<b>Serie</b>		<b>95.0</b>
<b>Total</b>		<b>189.0</b>

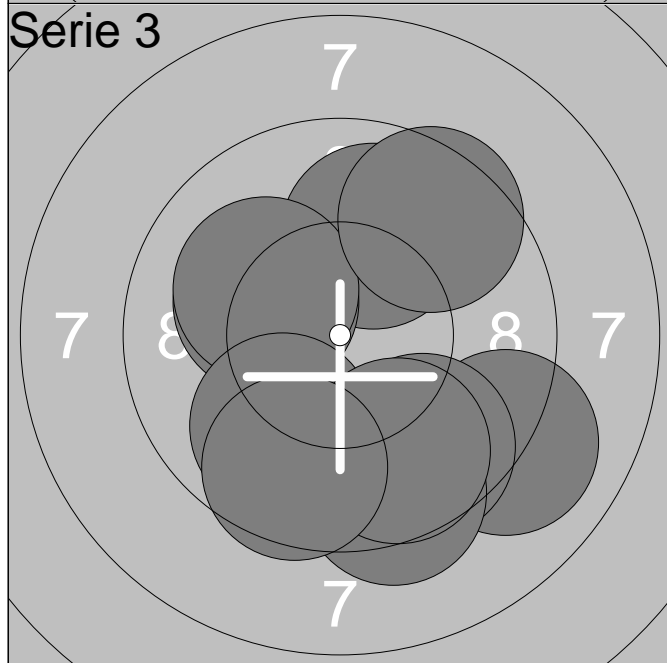

1:	9.9	↑
2:	10.2x	↖
3:	10.1	↗
4:	9.0	↘
5:	9.6	↘
6:	9.5	↗
7:	9.3	↓
8:	9.9	↖
9:	9.7	↓
10:	9.6	↓
<b>Serie</b>		<b>92.0</b>
<b>Total</b>		<b>281.0</b>

Lag <b>5</b>	Skive <b>11</b>	<b>Nils Erik Nordhagen</b>		
-----------------	--------------------	----------------------------	--	--

Luft	Hernes SSL	R15/16	
------	------------	--------	--

16.04.2015	Landsstevnet rekrutt 2015	LS Rekrutt 2015
------------	---------------------------	-----------------

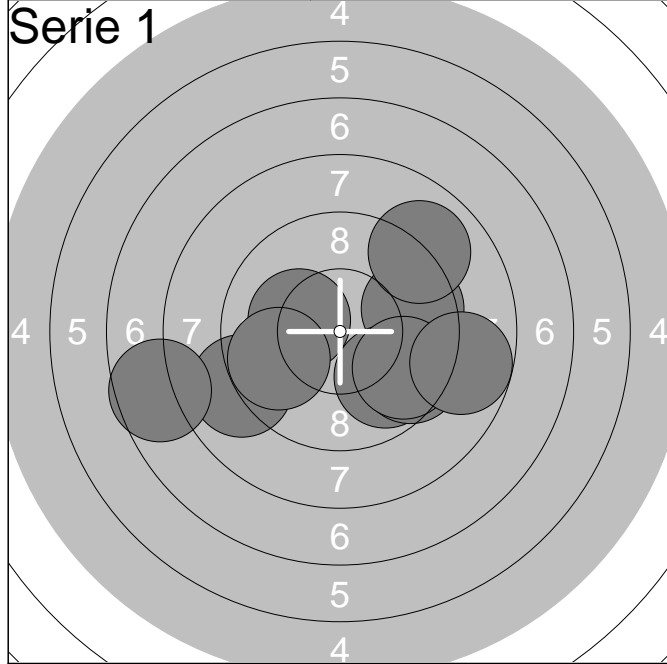

1:	10.2x	←
2:	9.0	↙
3:	9.6	→
4:	9.8	↘
5:	9.5	↘
6:	9.0	↗
7:	9.7	↘
8:	9.7	←
9:	8.7	→
10:	7.6	←
<b>Serie</b>		<b>88.0</b>
<b>Total</b>		<b>88.0</b>

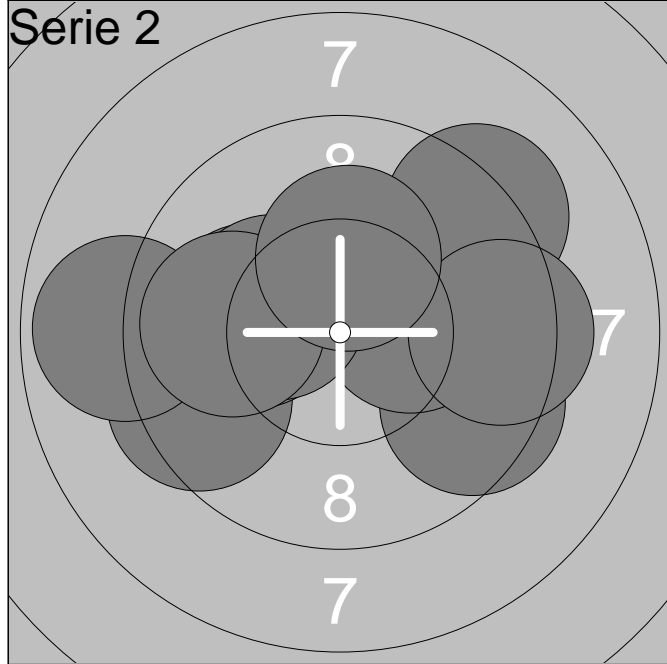

1:	9.5	↘
2:	9.4	←
3:	10.2x	→
4:	10.1	←
5:	9.2	↗
6:	9.4	→
7:	10.2x	←
8:	8.8	←
9:	9.9	←
10:	10.2x	↑
<b>Serie</b>		<b>93.0</b>
<b>Total</b>		<b>181.0</b>

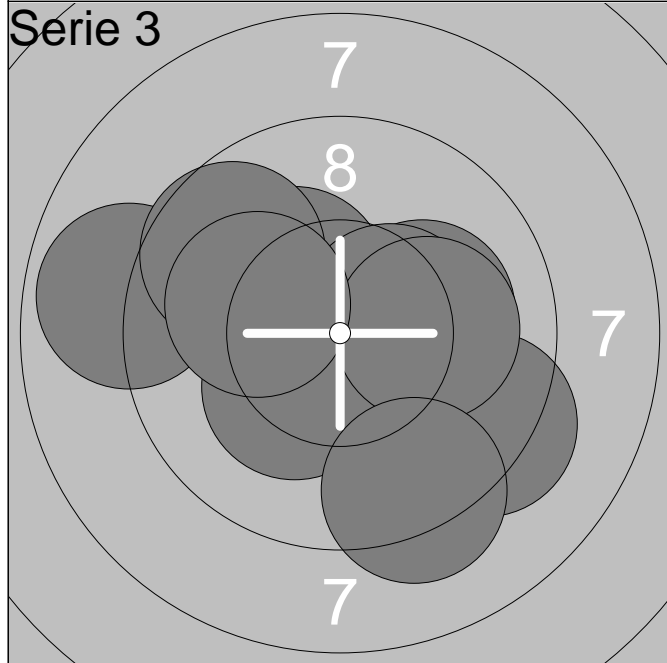

1:	10.1	→
2:	8.9	←
3:	10.2x	↗
4:	9.3	↘
5:	10.4x	→
6:	10.3x	↙
7:	10.1	→
8:	9.7	↗
9:	9.2	↘
10:	10.1	←
<b>Serie</b>		<b>95.0</b>
<b>Total</b>		<b>276.0</b>



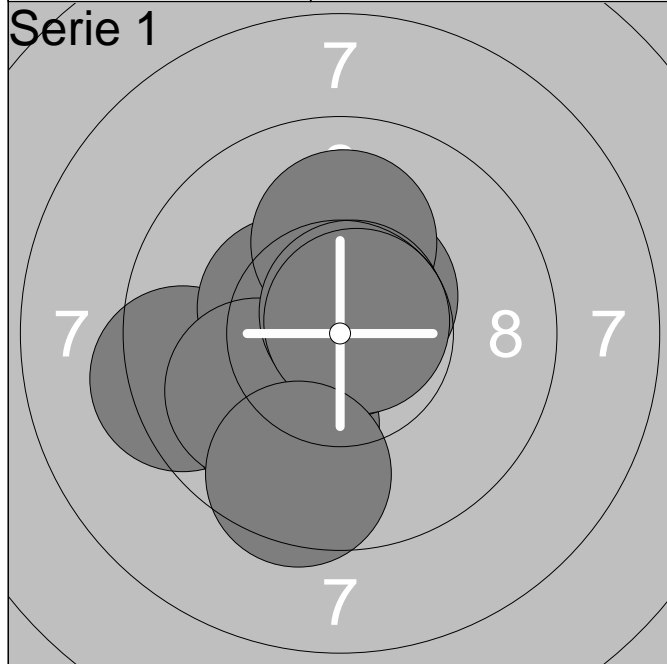

1:	10.5x	↗
2:	9.3	←
3:	9.9	↙
4:	10.8x	↗
5:	10.4x	↖
6:	10.1	↑
7:	9.9	↙
8:	10.7x	↗
9:	10.7x	↗
10:	9.5	↘
<b>Serie</b>		<b>96.0</b>
<b>Total</b>		<b>96.0</b>

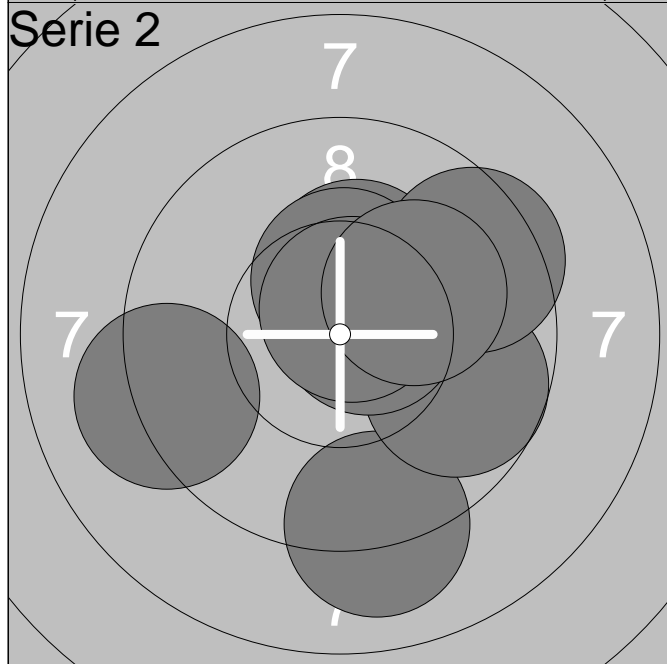

1:	9.0	↘
2:	10.3x	↑
3:	9.7	→
4:	10.6x	↗
5:	10.6x	→
6:	9.5	↗
7:	10.4x	↑
8:	10.7x	↗
9:	10.1	↗
10:	9.1	←
<b>Serie</b>		<b>96.0</b>
<b>Total</b>		<b>192.0</b>

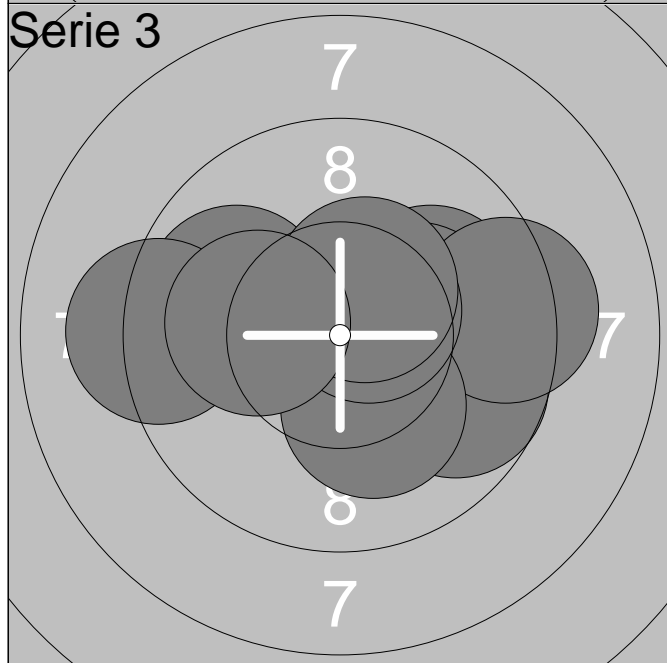

1:	9.9	←
2:	9.2	←
3:	9.7	→
4:	10.0	→
5:	10.2x	→
6:	9.3	→
7:	10.2x	↘
8:	10.6x	↗
9:	10.4x	↗
10:	10.1	←
<b>Serie</b>		<b>96.0</b>
<b>Total</b>		<b>288.0</b>

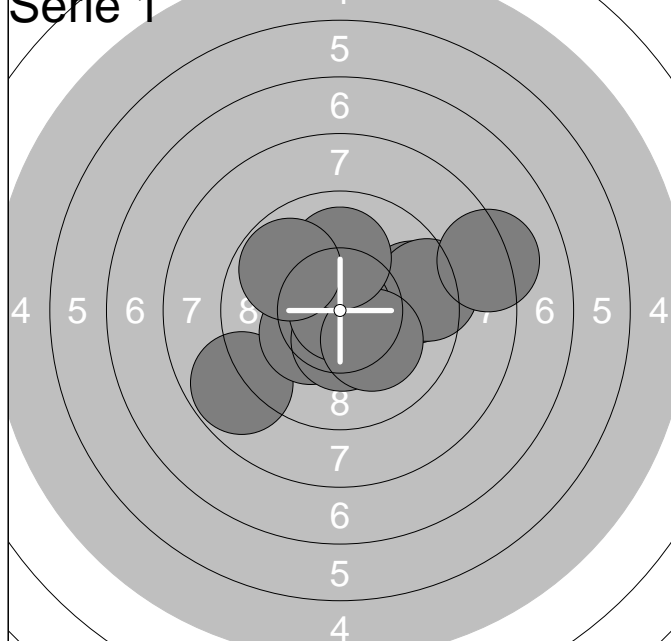

1:	9.6	→
2:	9.4	→
3:	8.2	→
4:	8.8	←
5:	10.3x	←
6:	10.4x	↓
7:	10.9x	↓
8:	10.2x	↘
9:	10.0	↑
10:	9.8	↖
<b>Serie</b>		<b>93.0</b>
<b>Total</b>		<b>93.0</b>

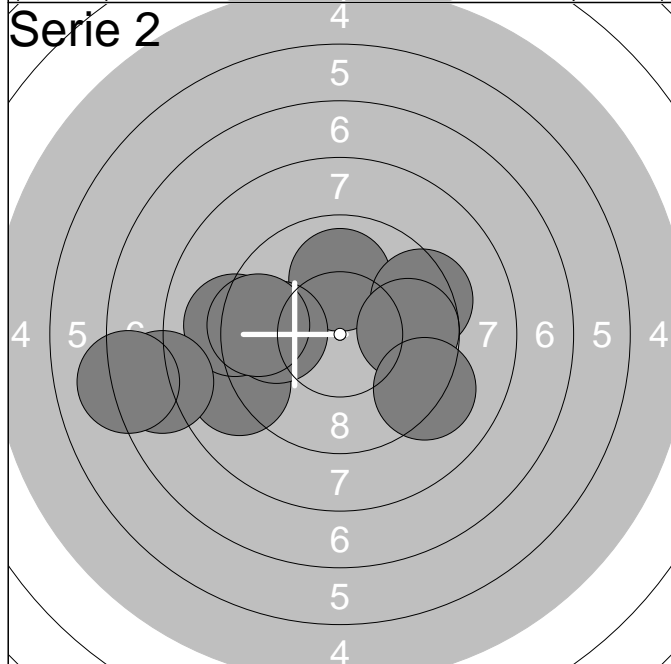

1:	10.0	↑
2:	9.0	←
3:	9.4	→
4:	9.1	←
5:	7.7	←
6:	9.7	→
7:	9.2	↘
8:	9.8	←
9:	7.1	←
10:	9.5	←
<b>Serie</b>		<b>87.0</b>
<b>Total</b>		<b>180.0</b>

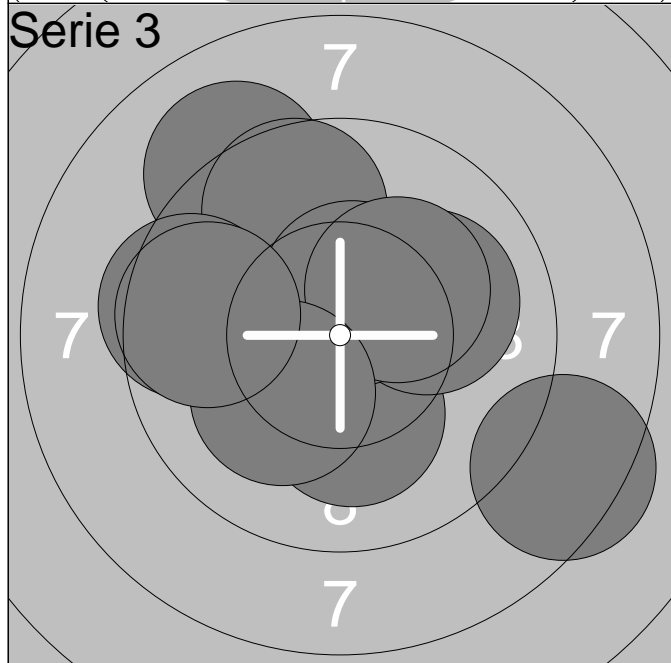

1:	10.2x	↓
2:	9.1	↖
3:	9.6	↖
4:	10.0	→
5:	10.5x	↑
6:	9.5	←
7:	10.2x	↗
8:	10.1	↘
9:	8.4	↘
10:	9.6	←
<b>Serie</b>		<b>94.0</b>
<b>Total</b>		<b>274.0</b>

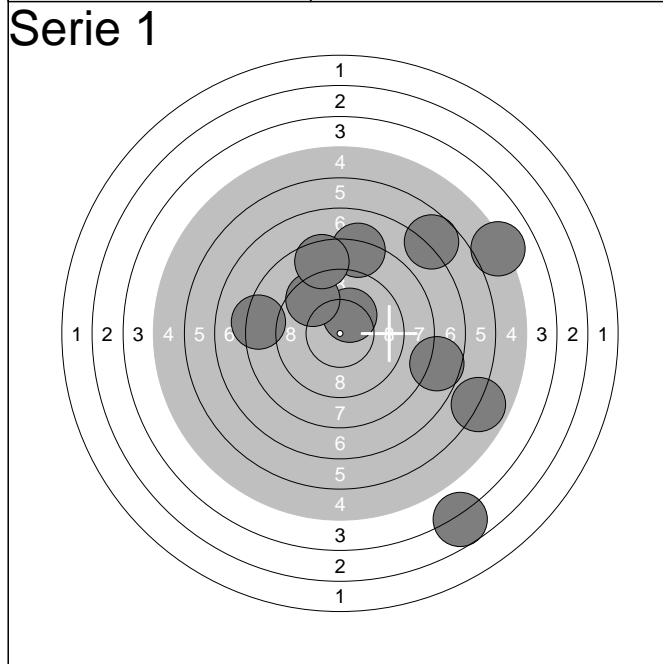

1:	5.8	→
2:	10.2x	↗
3:	8.2	↑
4:	9.5	↗
5:	3.7	↘
6:	6.7	↗
7:	7.6	→
8:	8.5	↑
9:	8.2	←
10:	5.1	↗
<b>Serie</b>		<b>69.0</b>
<b>Total</b>		<b>69.0</b>

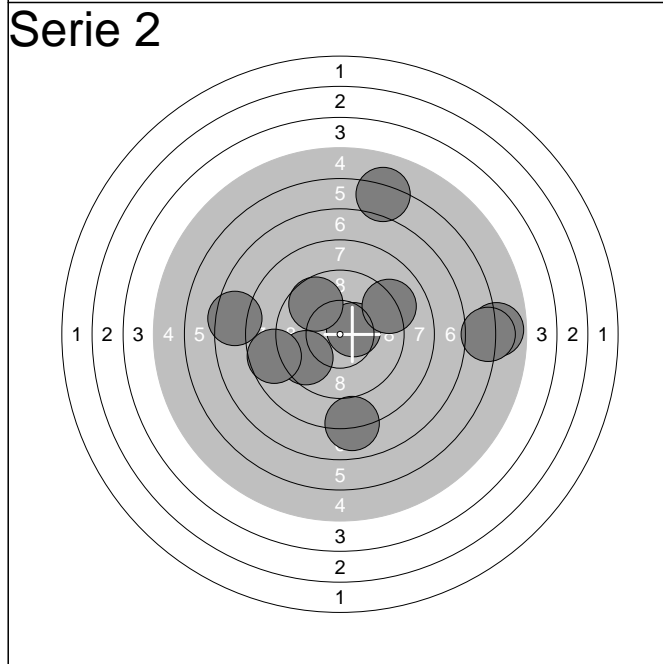

1:	9.6	↖
2:	8.7	←
3:	8.0	↓
4:	6.2	↑
5:	5.8	→
6:	6.1	→
7:	7.4	←
8:	10.4x	→
9:	9.1	↗
10:	9.6	↖
<b>Serie</b>		<b>77.0</b>
<b>Total</b>		<b>146.0</b>

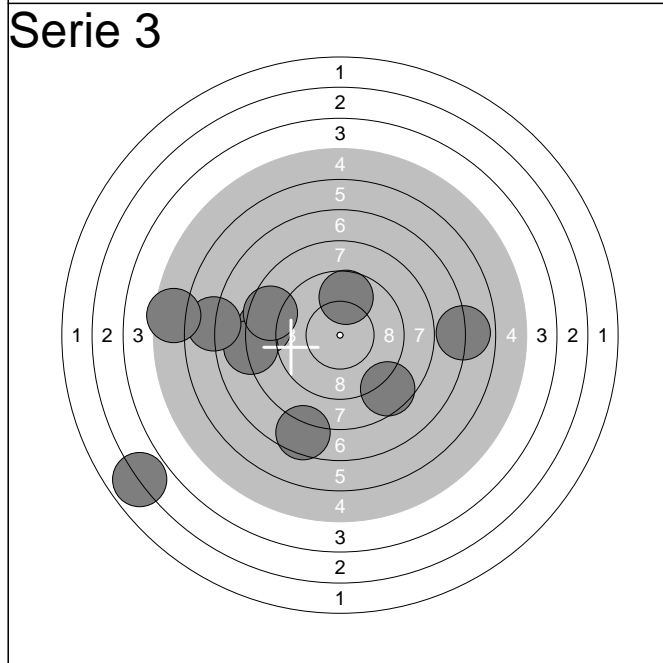

1:	7.5	↓
2:	8.5	←
3:	8.0	←
4:	6.8	←
5:	8.6	↘
6:	6.9	→
7:	2.8	↖
8:	9.7	↑
9:	8.5	←
10:	5.5	←
<b>Serie</b>		<b>67.0</b>
<b>Total</b>		<b>213.0</b>

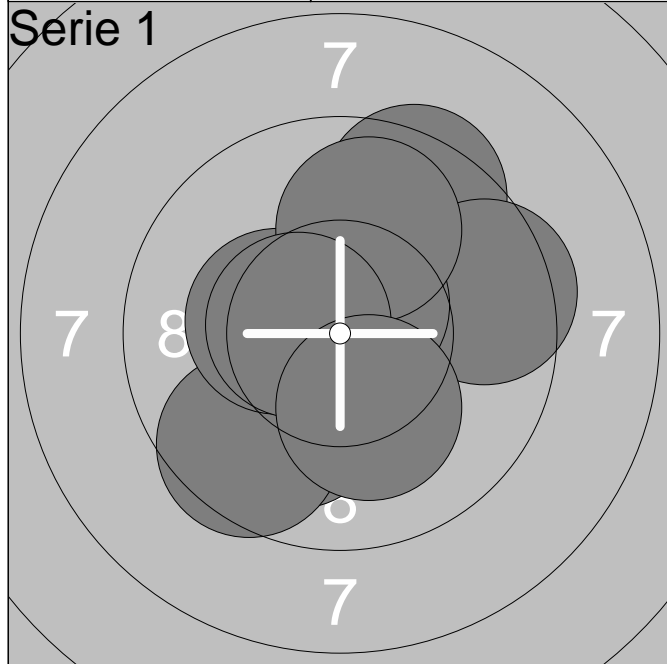

1:	10.0	↙
2:	9.4	↗
3:	9.5	↙
4:	10.9x	→
5:	10.3x	←
6:	9.5	→
7:	10.6x	↗
8:	9.9	↗
9:	10.5x	←
10:	10.1	↘
<b>Serie</b>		<b>96.0</b>
<b>Total</b>		<b>96.0</b>

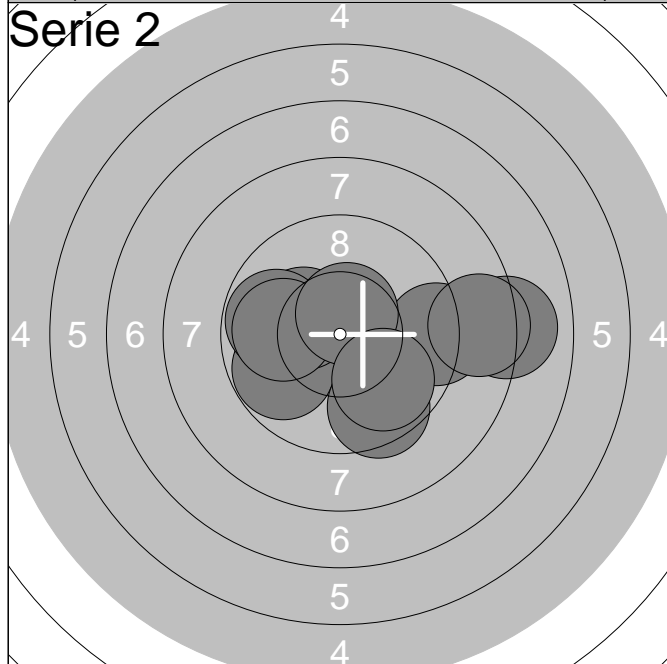

1:	9.7	↙
2:	10.2x	↖
3:	9.5	↘
4:	9.3	→
5:	9.8	←
6:	8.0	→
7:	9.9	←
8:	10.6x	↗
9:	9.8	↘
10:	8.5	→
<b>Serie</b>		<b>90.0</b>
<b>Total</b>		<b>186.0</b>

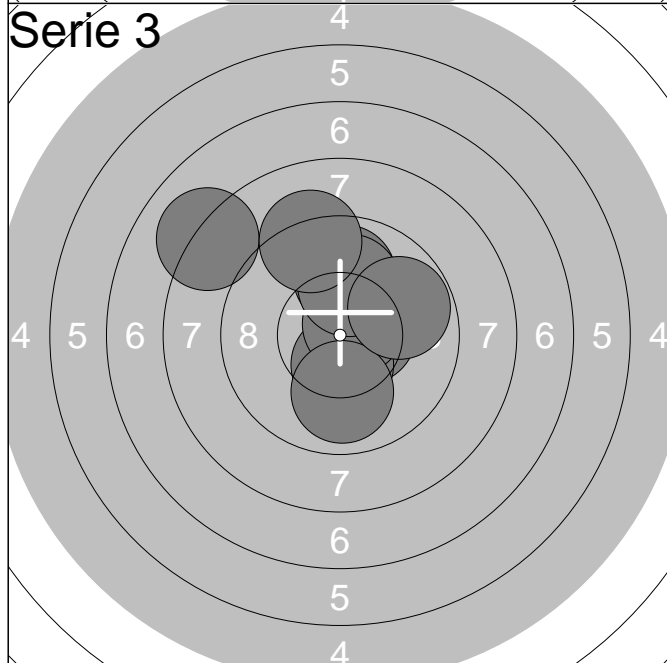

1:	10.1	↗
2:	10.5x	→
3:	10.4x	↘
4:	10.6x	↗
5:	9.9	↘
6:	9.9	↗
7:	10.0	↗
8:	8.1	↖
9:	9.8	↗
10:	9.2	↗
<b>Serie</b>		<b>94.0</b>
<b>Total</b>		<b>280.0</b>

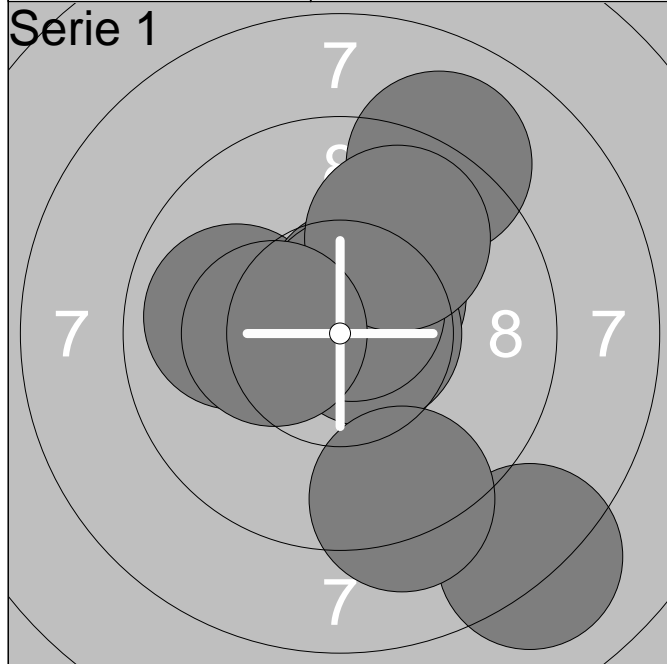

1:	9.9	←
2:	10.6x	↗
3:	10.4x	↗
4:	9.0	↗
5:	10.6x	→
6:	10.7x	↗
7:	9.8	↗
8:	10.3x	←
9:	8.1	↘
10:	9.2	↘
<b>Serie</b>	<b>94.0</b>	
<b>Total</b>	<b>94.0</b>	

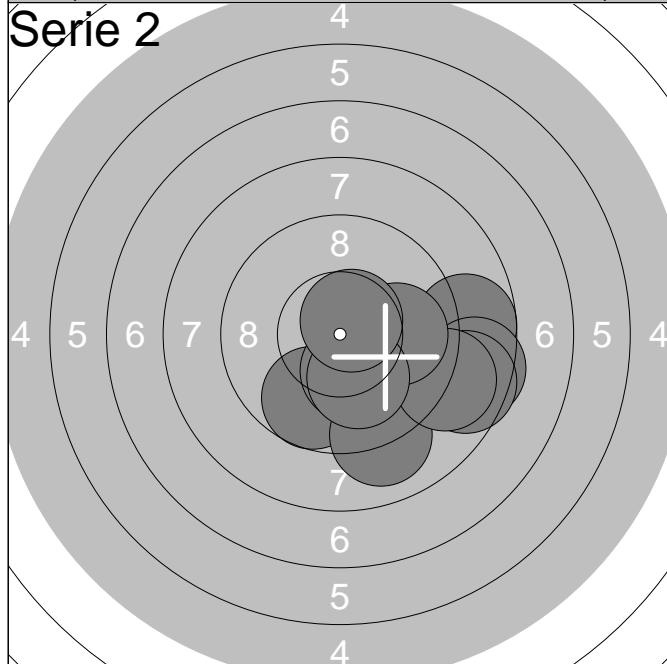

1:	9.7	↘
2:	10.3x	↘
3:	9.0	↘
4:	8.7	→
5:	8.5	→
6:	8.6	→
7:	8.9	→
8:	9.9	→
9:	10.1	↘
10:	10.6x	↗
<b>Serie</b>	<b>89.0</b>	
<b>Total</b>	<b>183.0</b>	

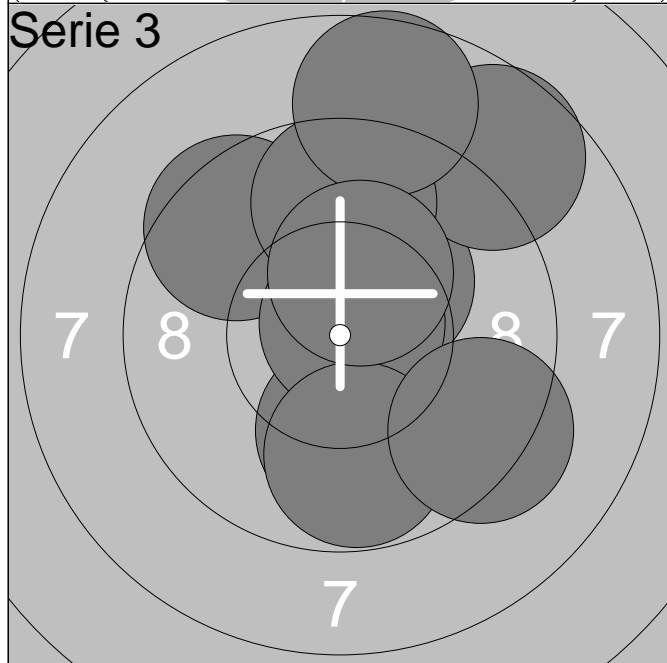

1:	10.0	↘
2:	10.3x	↗
3:	9.5	↖
4:	10.8x	↗
5:	8.7	↗
6:	9.8	↘
7:	9.7	↑
8:	8.6	↑
9:	10.3x	↗
10:	9.3	↘
<b>Serie</b>	<b>92.0</b>	
<b>Total</b>	<b>275.0</b>	

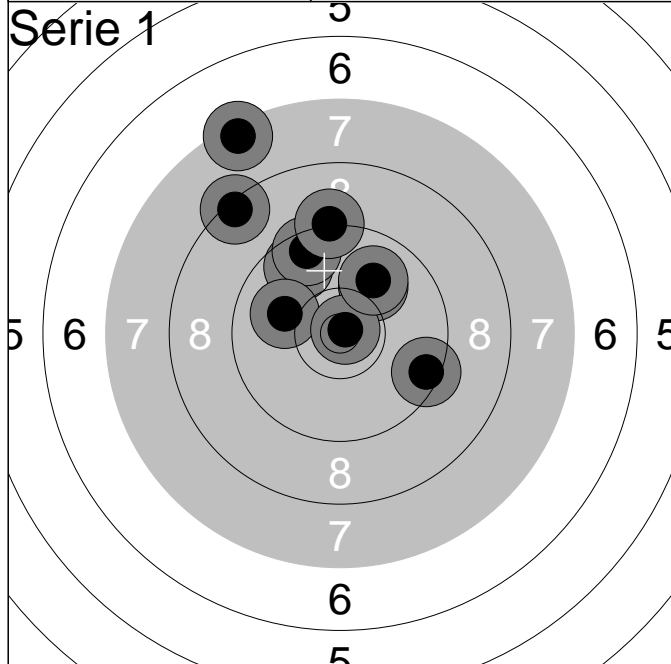

1:	9.7	↗
2:	7.4	↗
3:	8.4	↗
4:	9.4	↘
5:	9.5	↗
6:	10.0	↗
7:	9.2	↗
8:	10.0	↖
9:	10.8x	↗
10:	9.9	↗
<b>Serie</b>		<b>90.0</b>
<b>Total</b>		<b>90.0</b>

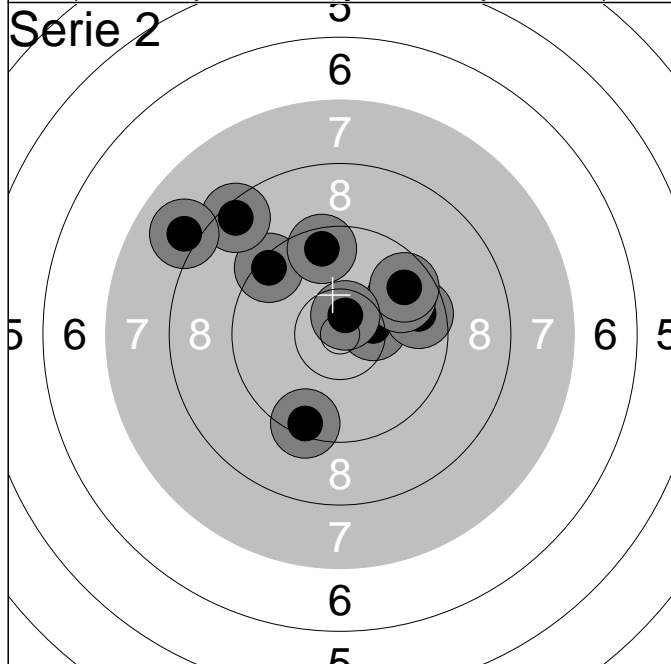

1:	9.4	↗
2:	10.4x	→
3:	8.5	↗
4:	9.7	→
5:	9.8	↗
6:	9.7	↗
7:	8.0	↗
8:	10.6x	↗
9:	9.4	↘
10:	9.5	↗
<b>Serie</b>		<b>90.0</b>
<b>Total</b>		<b>180.0</b>

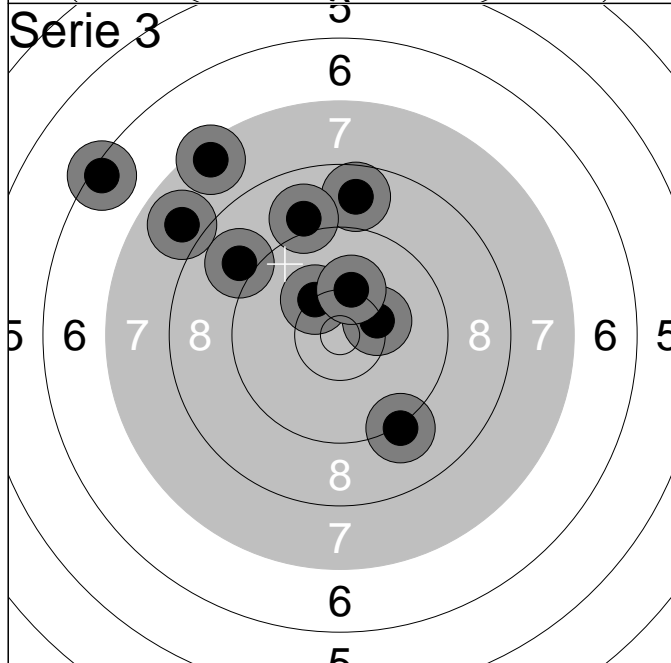

1:	9.2	↘
2:	8.7	↗
3:	10.3	↗
4:	7.5	↗
5:	10.3	→
6:	9.0	↗
7:	6.4	↗
8:	7.9	↗
9:	9.0	↗
10:	10.2	↗
<b>Serie</b>		<b>85.0</b>
<b>Total</b>		<b>265.0</b>

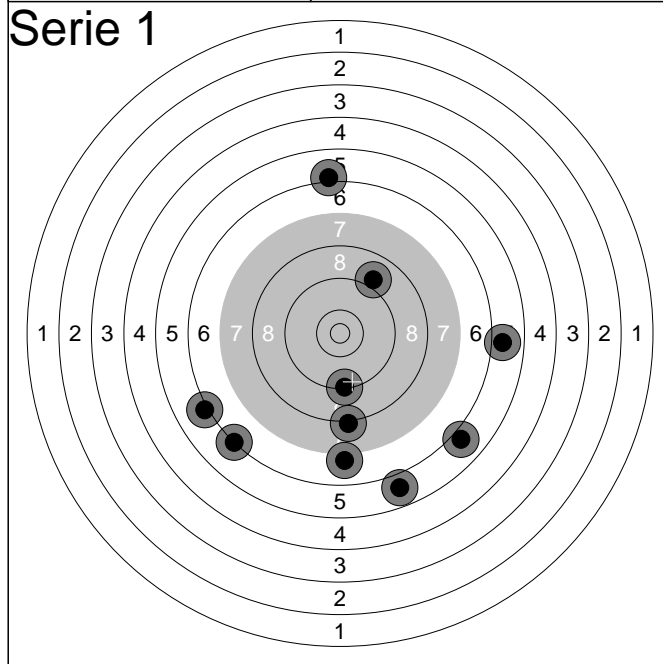

1:	9.3	↓
2:	6.1	↙
3:	7.0	↓
4:	6.1	↑
5:	8.1	↓
6:	6.2	↙
7:	6.0	↘
8:	9.0	↗
9:	5.8	↓
10:	5.9	→
<b>Serie</b>		<b>67.0</b>
<b>Total</b>		<b>67.0</b>

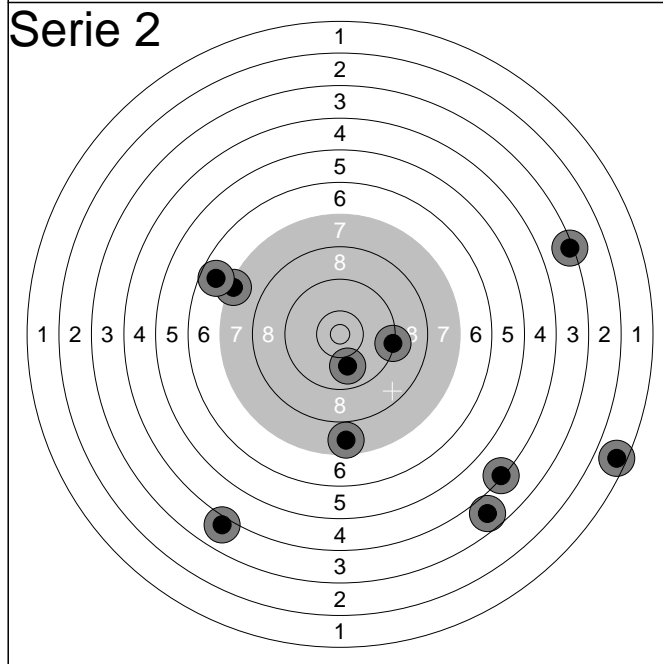

1:	4.0	↙
2:	4.3	↘
3:	3.8	↘
4:	7.3	↗
5:	6.7	↗
6:	3.3	→
7:	1.5	↘
8:	9.9	↓
9:	9.3	→
10:	7.7	↓
<b>Serie</b>		<b>53.0</b>
<b>Total</b>		<b>120.0</b>

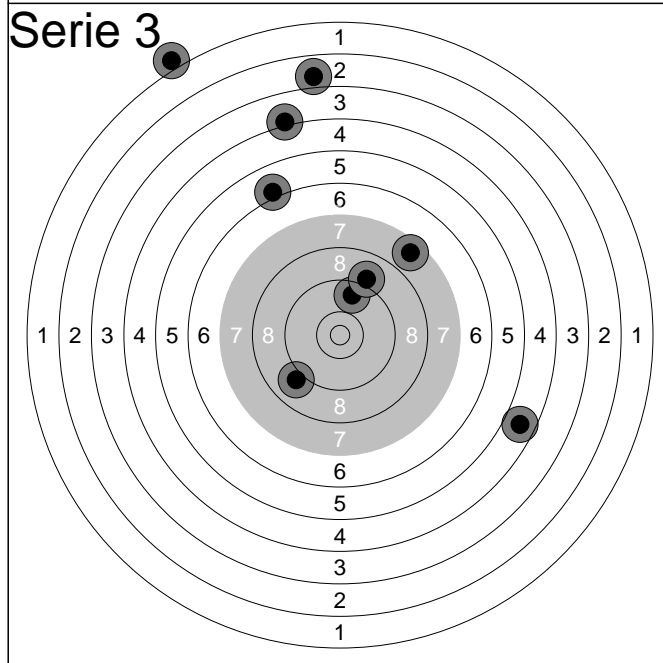

1:	9.6	↑
2:	9.0	↙
3:	7.6	↗
4:	6.0	↑
5:	4.7	↘
6:	4.1	↑
7:	0.0	↗
8:	9.0	↗
9:	2.9	↑
10:	0.0	↑
<b>Serie</b>		<b>50.0</b>
<b>Total</b>		<b>170.0</b>

16.04.2015	Landsstevnet rekrutt 2015	LS Rekrutt 2015
------------	---------------------------	-----------------

  

<p><b>Serie 1</b></p>	<table style="width:100%; border-collapse: collapse;"> <tr><td style="text-align: right;">1:</td><td style="text-align: right;">9.4</td><td style="text-align: right;">↗</td></tr> <tr><td style="text-align: right;">2:</td><td style="text-align: right;">8.5</td><td style="text-align: right;">↘</td></tr> <tr><td style="text-align: right;">3:</td><td style="text-align: right;">8.6</td><td style="text-align: right;">←</td></tr> <tr><td style="text-align: right;">4:</td><td style="text-align: right;">10.1</td><td style="text-align: right;">↗</td></tr> <tr><td style="text-align: right;">5:</td><td style="text-align: right;">8.8</td><td style="text-align: right;">→</td></tr> <tr><td style="text-align: right;">6:</td><td style="text-align: right;">9.2</td><td style="text-align: right;">←</td></tr> <tr><td style="text-align: right;">7:</td><td style="text-align: right;">8.5</td><td style="text-align: right;">↘</td></tr> <tr><td style="text-align: right;">8:</td><td style="text-align: right;">5.4</td><td style="text-align: right;">↙</td></tr> <tr><td style="text-align: right;">9:</td><td style="text-align: right;">10.7x</td><td style="text-align: right;">↘</td></tr> <tr><td style="text-align: right;">10:</td><td style="text-align: right;">9.1</td><td style="text-align: right;">→</td></tr> <tr><td colspan="2"><b>Serie</b></td><td style="text-align: right;"><b>84.0</b></td></tr> <tr><td colspan="2"><b>Total</b></td><td style="text-align: right;"><b>84.0</b></td></tr> </table>	1:	9.4	↗	2:	8.5	↘	3:	8.6	←	4:	10.1	↗	5:	8.8	→	6:	9.2	←	7:	8.5	↘	8:	5.4	↙	9:	10.7x	↘	10:	9.1	→	<b>Serie</b>		<b>84.0</b>	<b>Total</b>		<b>84.0</b>
1:	9.4	↗																																			
2:	8.5	↘																																			
3:	8.6	←																																			
4:	10.1	↗																																			
5:	8.8	→																																			
6:	9.2	←																																			
7:	8.5	↘																																			
8:	5.4	↙																																			
9:	10.7x	↘																																			
10:	9.1	→																																			
<b>Serie</b>		<b>84.0</b>																																			
<b>Total</b>		<b>84.0</b>																																			
<p><b>Serie 2</b></p>	<table style="width:100%; border-collapse: collapse;"> <tr><td style="text-align: right;">1:</td><td style="text-align: right;">7.9</td><td style="text-align: right;">→</td></tr> <tr><td style="text-align: right;">2:</td><td style="text-align: right;">8.9</td><td style="text-align: right;">↘</td></tr> <tr><td style="text-align: right;">3:</td><td style="text-align: right;">8.5</td><td style="text-align: right;">↗</td></tr> <tr><td style="text-align: right;">4:</td><td style="text-align: right;">9.0</td><td style="text-align: right;">→</td></tr> <tr><td style="text-align: right;">5:</td><td style="text-align: right;">9.3</td><td style="text-align: right;">→</td></tr> <tr><td style="text-align: right;">6:</td><td style="text-align: right;">7.0</td><td style="text-align: right;">↗</td></tr> <tr><td style="text-align: right;">7:</td><td style="text-align: right;">8.6</td><td style="text-align: right;">↗</td></tr> <tr><td style="text-align: right;">8:</td><td style="text-align: right;">8.2</td><td style="text-align: right;">↗</td></tr> <tr><td style="text-align: right;">9:</td><td style="text-align: right;">8.1</td><td style="text-align: right;">↘</td></tr> <tr><td style="text-align: right;">10:</td><td style="text-align: right;">9.6</td><td style="text-align: right;">↗</td></tr> <tr><td colspan="2"><b>Serie</b></td><td style="text-align: right;"><b>81.0</b></td></tr> <tr><td colspan="2"><b>Total</b></td><td style="text-align: right;"><b>165.0</b></td></tr> </table>	1:	7.9	→	2:	8.9	↘	3:	8.5	↗	4:	9.0	→	5:	9.3	→	6:	7.0	↗	7:	8.6	↗	8:	8.2	↗	9:	8.1	↘	10:	9.6	↗	<b>Serie</b>		<b>81.0</b>	<b>Total</b>		<b>165.0</b>
1:	7.9	→																																			
2:	8.9	↘																																			
3:	8.5	↗																																			
4:	9.0	→																																			
5:	9.3	→																																			
6:	7.0	↗																																			
7:	8.6	↗																																			
8:	8.2	↗																																			
9:	8.1	↘																																			
10:	9.6	↗																																			
<b>Serie</b>		<b>81.0</b>																																			
<b>Total</b>		<b>165.0</b>																																			
<p><b>Serie 3</b></p>	<table style="width:100%; border-collapse: collapse;"> <tr><td style="text-align: right;">1:</td><td style="text-align: right;">9.5</td><td style="text-align: right;">→</td></tr> <tr><td style="text-align: right;">2:</td><td style="text-align: right;">6.8</td><td style="text-align: right;">↗</td></tr> <tr><td style="text-align: right;">3:</td><td style="text-align: right;">9.4</td><td style="text-align: right;">↘</td></tr> <tr><td style="text-align: right;">4:</td><td style="text-align: right;">8.9</td><td style="text-align: right;">→</td></tr> <tr><td style="text-align: right;">5:</td><td style="text-align: right;">9.5</td><td style="text-align: right;">↘</td></tr> <tr><td style="text-align: right;">6:</td><td style="text-align: right;">8.8</td><td style="text-align: right;">↘</td></tr> <tr><td style="text-align: right;">7:</td><td style="text-align: right;">9.3</td><td style="text-align: right;">↘</td></tr> <tr><td style="text-align: right;">8:</td><td style="text-align: right;">6.4</td><td style="text-align: right;">↗</td></tr> <tr><td style="text-align: right;">9:</td><td style="text-align: right;">7.3</td><td style="text-align: right;">←</td></tr> <tr><td style="text-align: right;">10:</td><td style="text-align: right;">10.0</td><td style="text-align: right;">↗</td></tr> <tr><td colspan="2"><b>Serie</b></td><td style="text-align: right;"><b>81.0</b></td></tr> <tr><td colspan="2"><b>Total</b></td><td style="text-align: right;"><b>246.0</b></td></tr> </table>	1:	9.5	→	2:	6.8	↗	3:	9.4	↘	4:	8.9	→	5:	9.5	↘	6:	8.8	↘	7:	9.3	↘	8:	6.4	↗	9:	7.3	←	10:	10.0	↗	<b>Serie</b>		<b>81.0</b>	<b>Total</b>		<b>246.0</b>
1:	9.5	→																																			
2:	6.8	↗																																			
3:	9.4	↘																																			
4:	8.9	→																																			
5:	9.5	↘																																			
6:	8.8	↘																																			
7:	9.3	↘																																			
8:	6.4	↗																																			
9:	7.3	←																																			
10:	10.0	↗																																			
<b>Serie</b>		<b>81.0</b>																																			
<b>Total</b>		<b>246.0</b>																																			



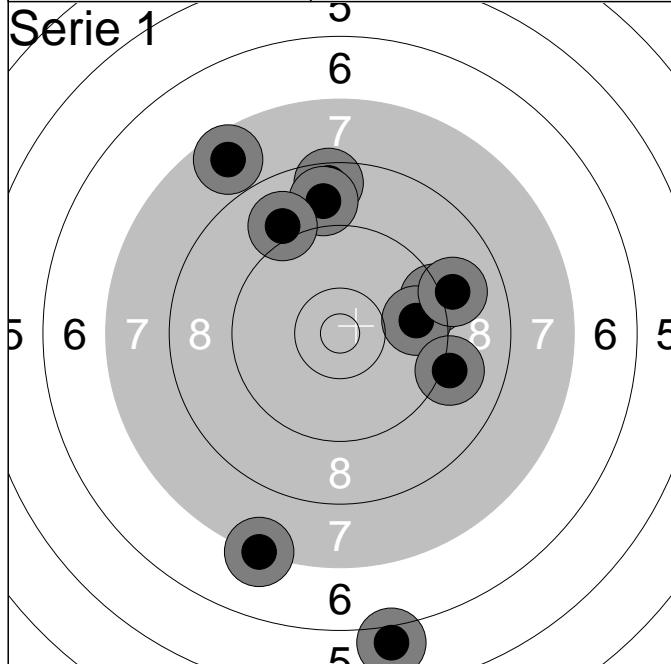

1:	8.6	↑
2:	7.2	↓
3:	6.0	↓
4:	9.3	→
5:	7.7	↑
6:	9.7	→
7:	8.8	↑
8:	9.0	→
9:	9.1	→
10:	9.0	↑
<b>Serie</b>		<b>81.0</b>
<b>Total</b>		<b>81.0</b>

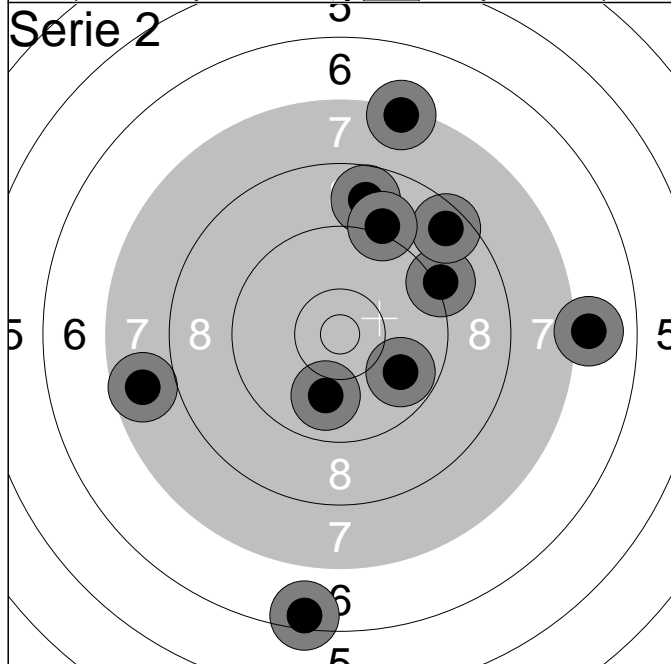

1:	9.1	→
2:	7.3	↑
3:	7.0	→
4:	8.8	↑
5:	9.9	↓
6:	8.6	↗
7:	9.8	↘
8:	7.7	←
9:	9.1	↑
10:	6.4	↓
<b>Serie</b>		<b>79.0</b>
<b>Total</b>		<b>160.0</b>

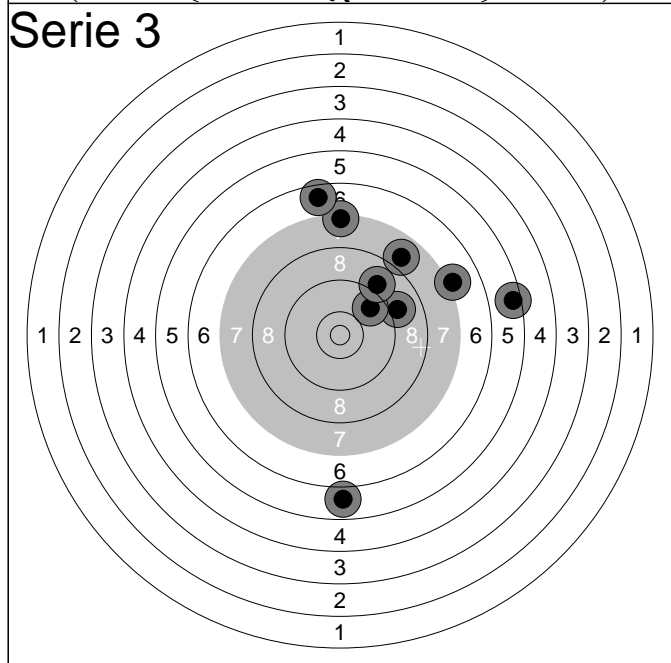

1:	0.0	↘
2:	7.9	↗
3:	5.5	→
4:	9.0	→
5:	9.7	↗
6:	7.3	↑
7:	9.0	↗
8:	6.6	↑
9:	5.8	↓
10:	7.1	→
<b>Serie</b>		<b>64.0</b>
<b>Total</b>		<b>224.0</b>

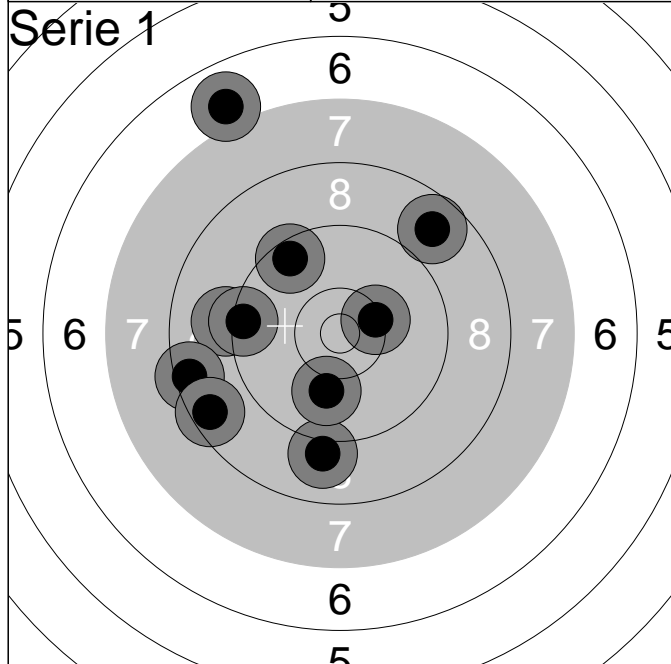

1:	6.9	↖
2:	10.3	→
3:	8.7	↗
4:	9.1	←
5:	8.5	←
6:	8.5	↙
7:	9.0	↓
8:	9.4	←
9:	10.0	↓
10:	9.5	↖
<b>Serie</b>		<b>86.0</b>
<b>Total</b>		<b>86.0</b>

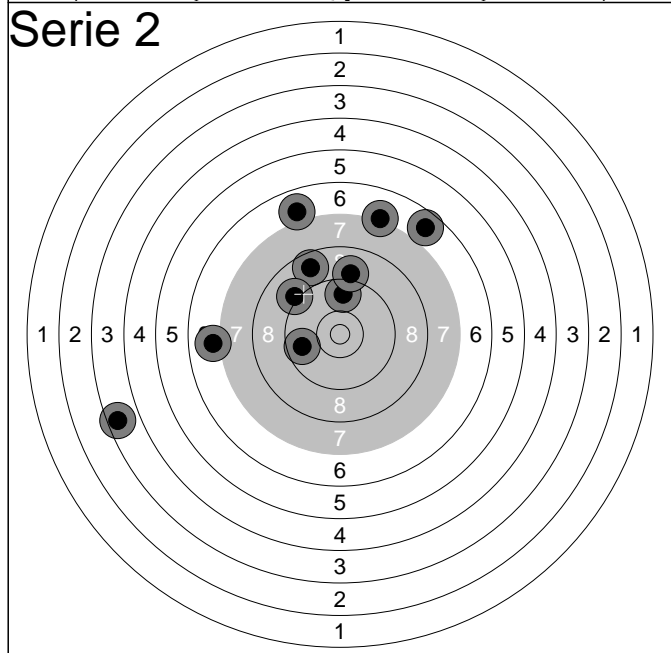

1:	9.7	↑
2:	8.7	↖
3:	6.9	↖
4:	7.0	←
5:	9.0	↑
6:	6.7	↗
7:	9.7	←
8:	3.5	←
9:	9.1	↖
10:	7.2	↖
<b>Serie</b>		<b>73.0</b>
<b>Total</b>		<b>159.0</b>

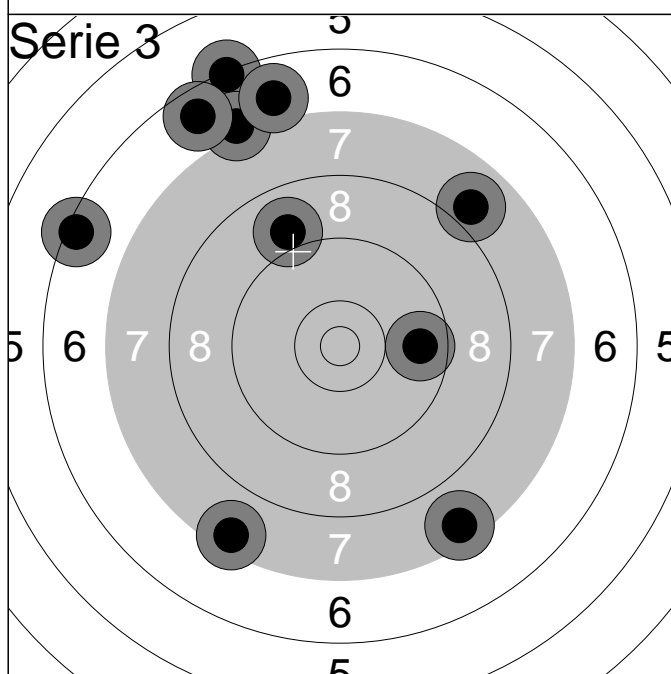

1:	7.9	↗
2:	6.3	↖
3:	9.0	↖
4:	7.1	↖
5:	9.7	→
6:	7.5	↙
7:	7.5	↙
8:	6.6	↖
9:	6.4	↖
10:	6.9	↖
<b>Serie</b>		<b>70.0</b>
<b>Total</b>		<b>229.0</b>

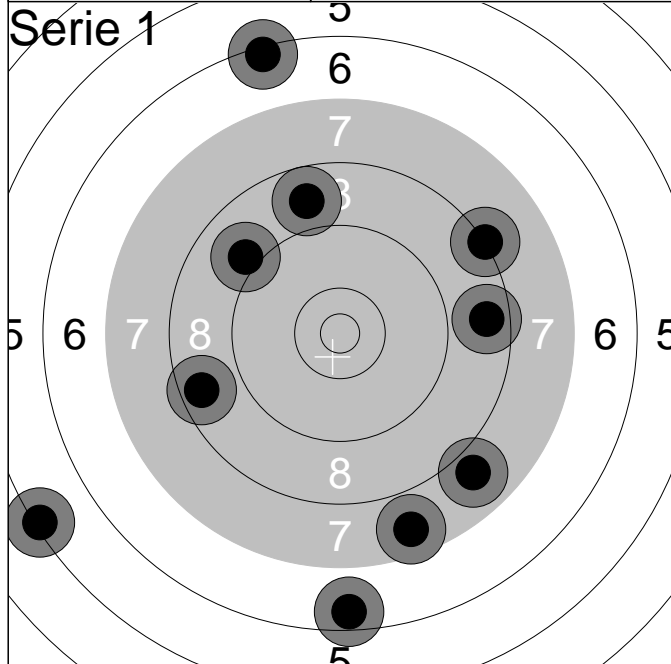

1:	8.6	→
2:	7.6	↓
3:	8.8	↑
4:	8.2	↗
5:	9.0	↗
6:	5.3	↖
7:	6.5	↓
8:	8.6	↖
9:	6.3	↑
10:	7.9	↓

Serie	<b>72.0</b>
Total	<b>72.0</b>

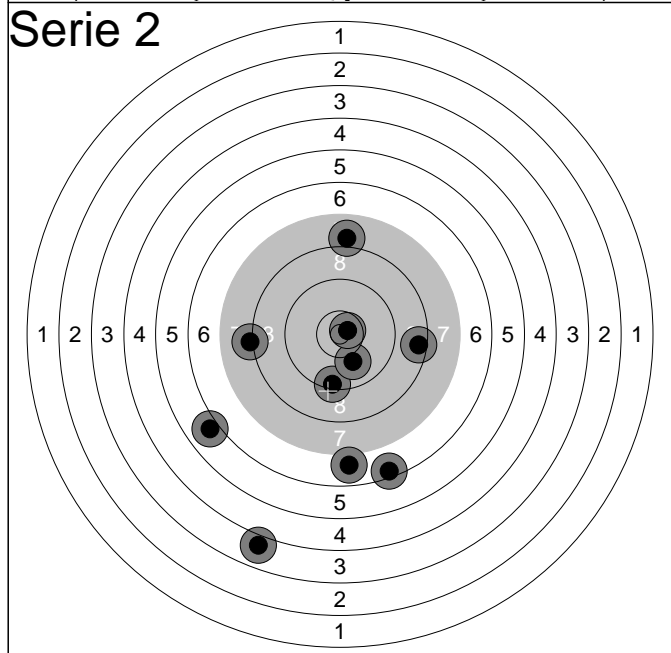

1:	8.5	→
2:	6.4	↓
3:	9.4	↓
4:	7.9	↑
5:	10.0	↓
6:	6.9	↓
7:	6.0	↖
8:	8.1	←
9:	3.9	↓
10:	10.7x	↗

Serie	<b>73.0</b>
Total	<b>145.0</b>

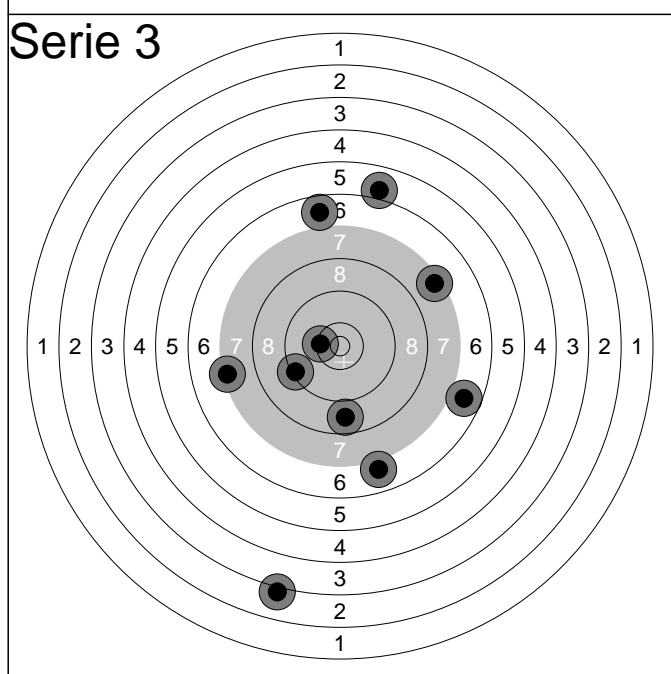

1:	6.8	↗
2:	10.3	←
3:	6.7	↑
4:	9.4	↖
5:	6.0	↑
6:	7.4	↗
7:	8.7	↓
8:	3.1	↓
9:	6.9	↓
10:	7.3	←

Serie	<b>68.0</b>
Total	<b>213.0</b>

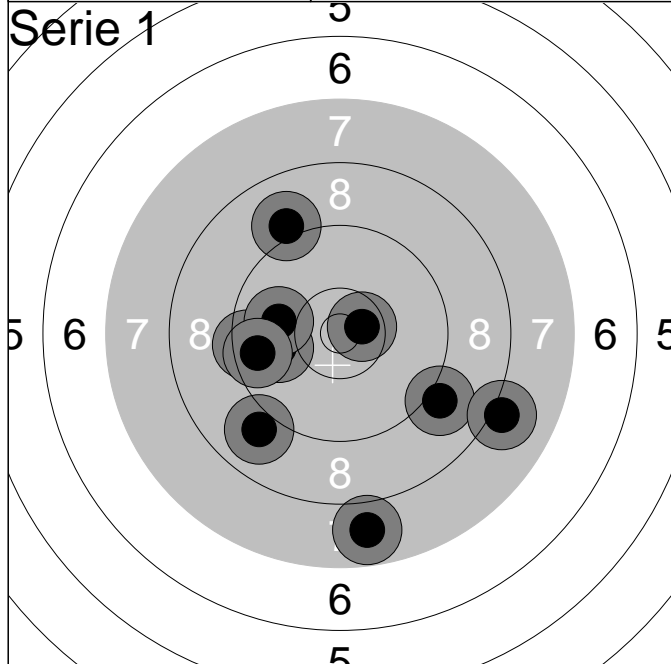

1:	9.5	←
2:	9.0	↗
3:	9.0	↘
4:	8.9	↙
5:	7.8	↓
6:	9.9	←
7:	9.9	←
8:	9.6	←
9:	8.1	↘
10:	10.6x	→
<b>Serie</b>		<b>87.0</b>
<b>Total</b>		<b>87.0</b>

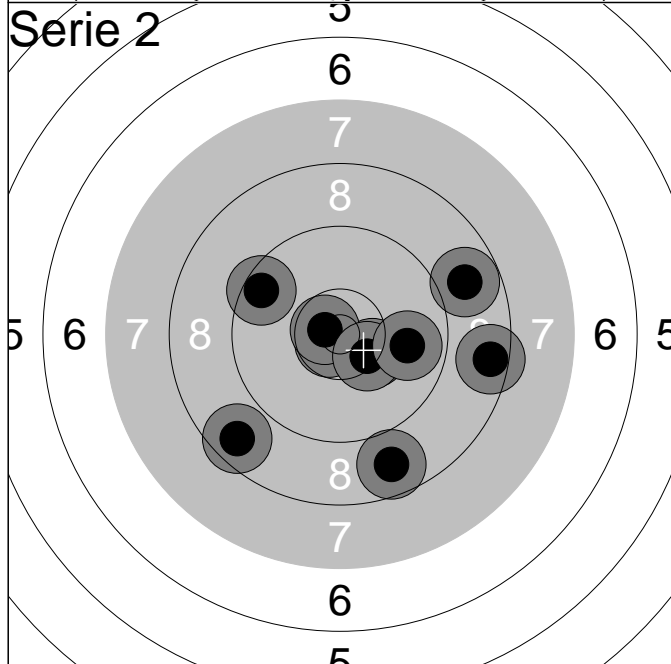

1:	8.6	↙
2:	10.4	↘
3:	10.7x	↙
4:	8.5	→
5:	9.5	↗
6:	10.7x	←
7:	10.4x	↘
8:	8.8	→
9:	8.7	↓
10:	9.8	→
<b>Serie</b>		<b>90.0</b>
<b>Total</b>		<b>177.0</b>

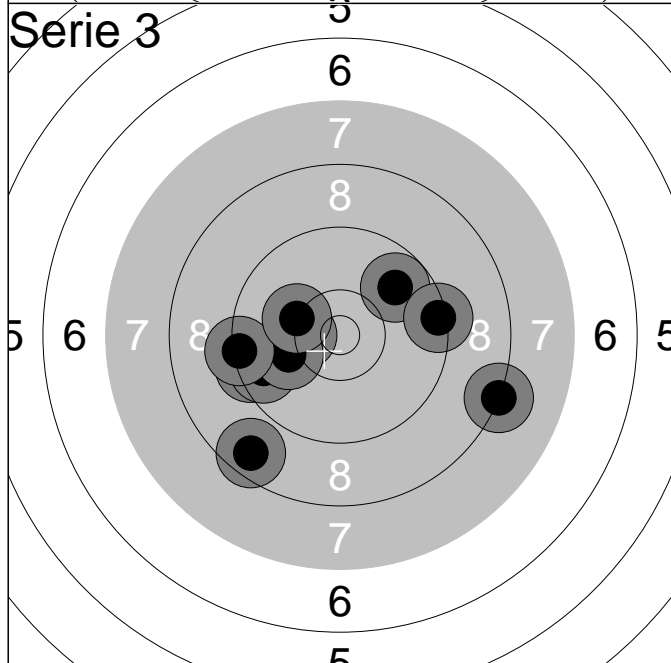

1:	9.4	←
2:	8.6	↙
3:	10.3	←
4:	8.2	→
5:	9.6	←
6:	9.8	↗
7:	9.4	→
8:	10.1	←
9:	9.3	←
10:	10.2	←
<b>Serie</b>		<b>91.0</b>
<b>Total</b>		<b>268.0</b>

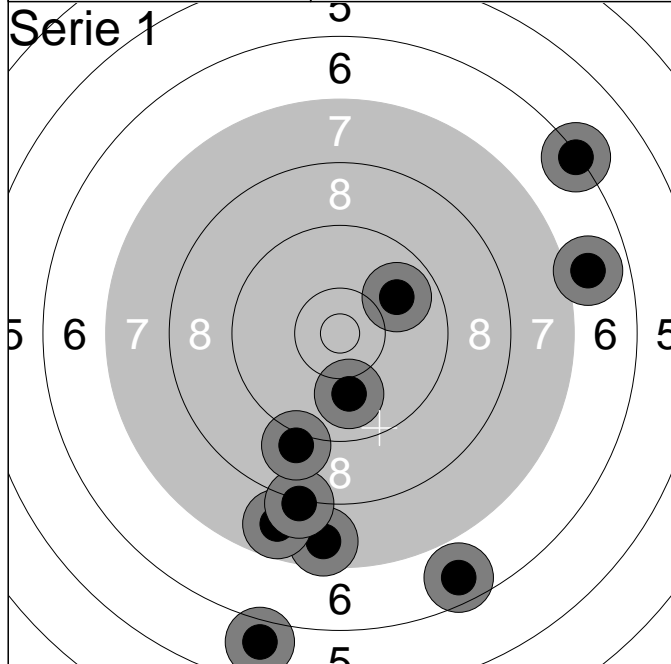

1:	5.9	↓
2:	7.6	↓
3:	10.0	↓
4:	7.8	↓
5:	6.6	↓
6:	9.9	↗
7:	6.9	→
8:	6.3	↗
9:	8.2	↓
10:	9.0	↓
<b>Serie</b>		<b>73.0</b>
<b>Total</b>		<b>73.0</b>

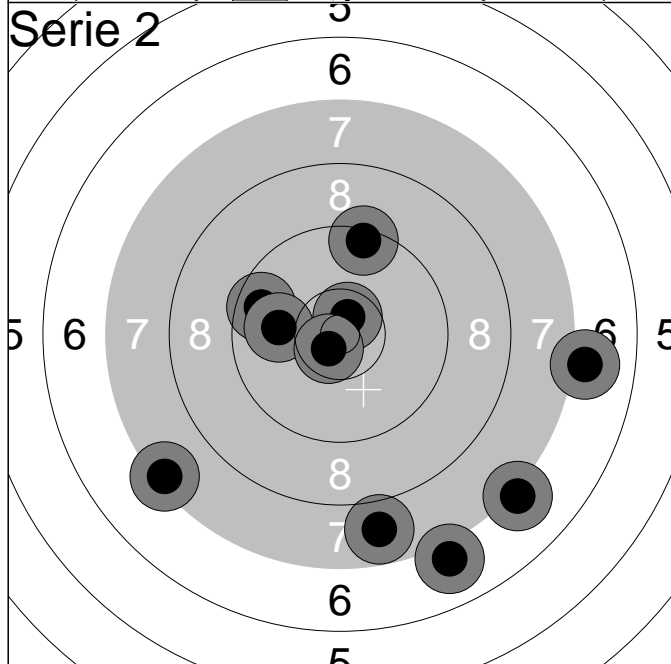

1:	7.1	↘
2:	7.8	↓
3:	7.3	↙
4:	10.6x	↗
5:	9.4	↗
6:	9.6	↖
7:	10.0	↖
8:	7.0	↓
9:	10.7x	↙
10:	7.0	→
<b>Serie</b>		<b>83.0</b>
<b>Total</b>		<b>156.0</b>

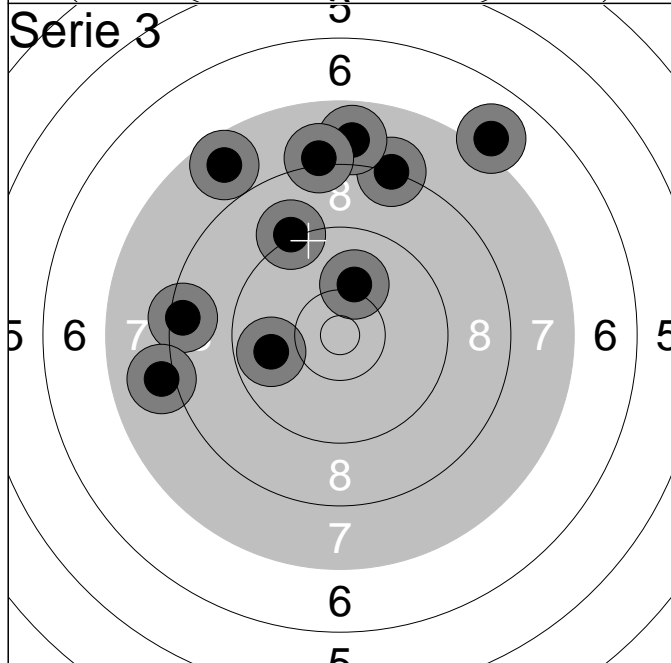

1:	10.1	↗
2:	8.4	↖
3:	7.7	↗
4:	8.2	↗
5:	7.8	↗
6:	9.8	↖
7:	7.0	↗
8:	8.0	↖
9:	8.1	↗
10:	9.2	↗
<b>Serie</b>		<b>81.0</b>
<b>Total</b>		<b>237.0</b>

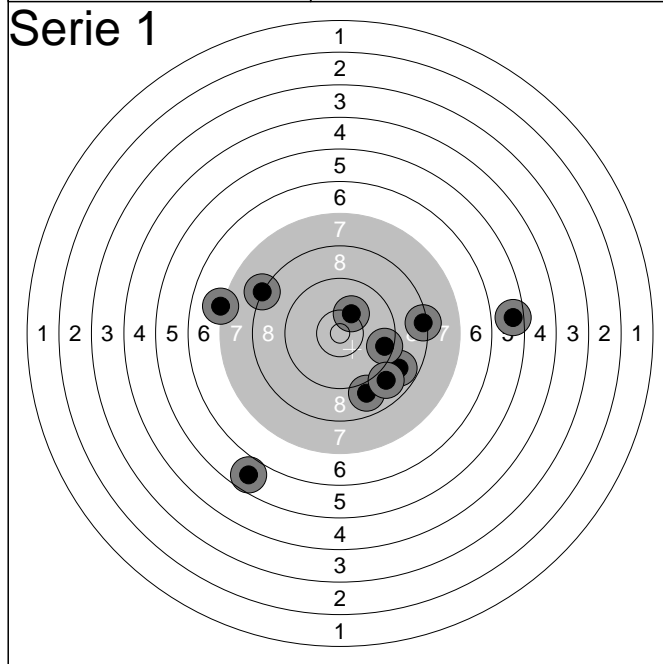

1:	10.2	↗
2:	8.8	↘
3:	5.6	→
4:	8.4	→
5:	8.9	↘
6:	5.7	↘
7:	9.5	→
8:	8.2	↗
9:	8.9	↘
10:	7.1	←
<b>Serie</b>		<b>76.0</b>
<b>Total</b>		<b>76.0</b>

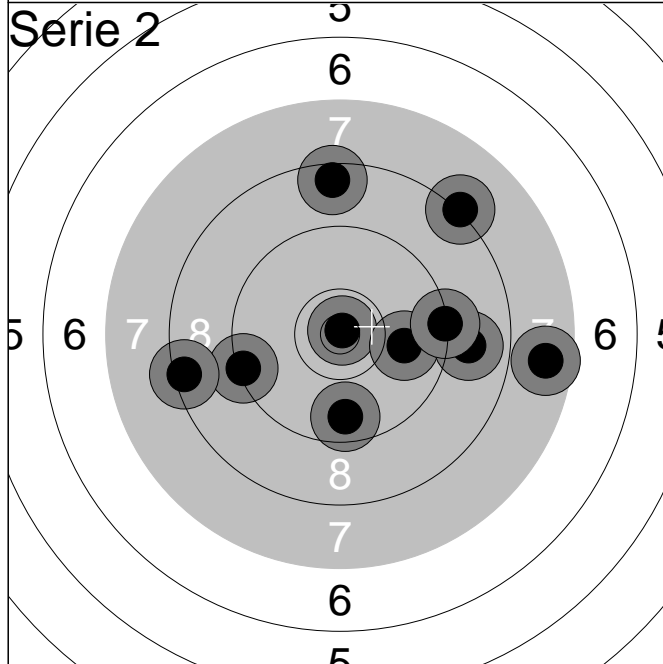

1:	10.9x	↗
2:	9.9	→
3:	8.9	→
4:	9.3	←
5:	9.3	→
6:	8.5	↑
7:	9.6	↓
8:	7.7	→
9:	8.4	←
10:	8.2	↗
<b>Serie</b>		<b>85.0</b>
<b>Total</b>		<b>161.0</b>

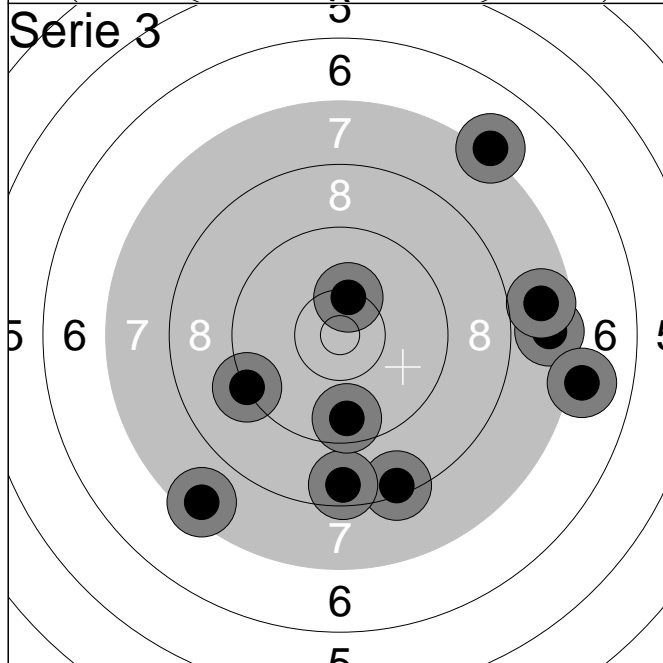

1:	10.3	↑
2:	7.6	→
3:	7.7	→
4:	7.0	→
5:	9.3	←
6:	7.5	↘
7:	7.1	↗
8:	8.4	↓
9:	8.6	↓
10:	9.6	↓
<b>Serie</b>		<b>79.0</b>
<b>Total</b>		<b>240.0</b>

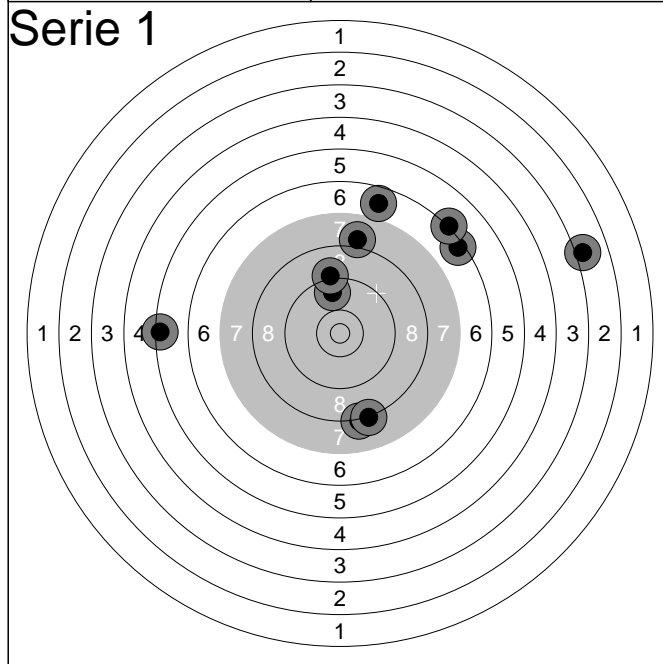

1:	6.4	↗
2:	8.2	↓
3:	6.7	↑
4:	9.6	↑
5:	8.2	↓
6:	5.4	←
7:	3.0	→
8:	9.1	↑
9:	8.0	↑
10:	6.2	↗
<b>Serie</b>		<b>68.0</b>
<b>Total</b>		<b>68.0</b>

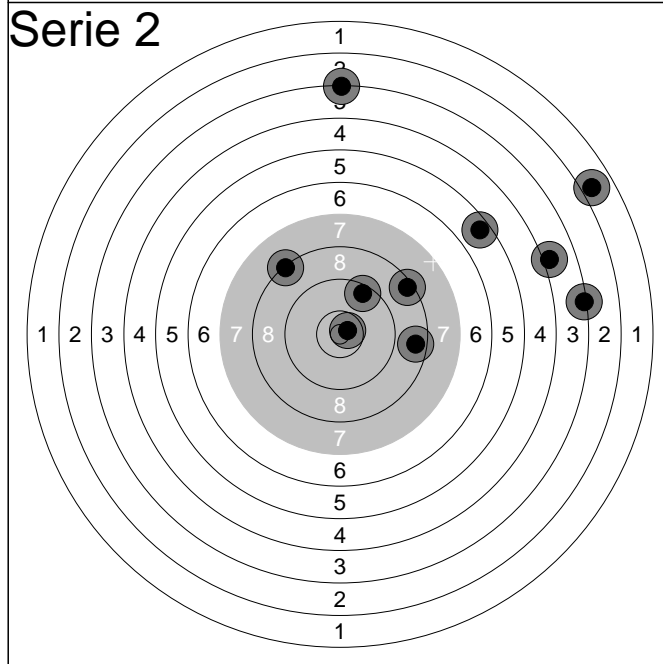

1:	9.5	↗
2:	8.6	→
3:	8.3	↖
4:	3.3	↑
5:	3.3	→
6:	4.1	→
7:	8.4	↗
8:	1.9	↗
9:	5.5	↗
10:	10.7x	↗
<b>Serie</b>		<b>59.0</b>
<b>Total</b>		<b>127.0</b>

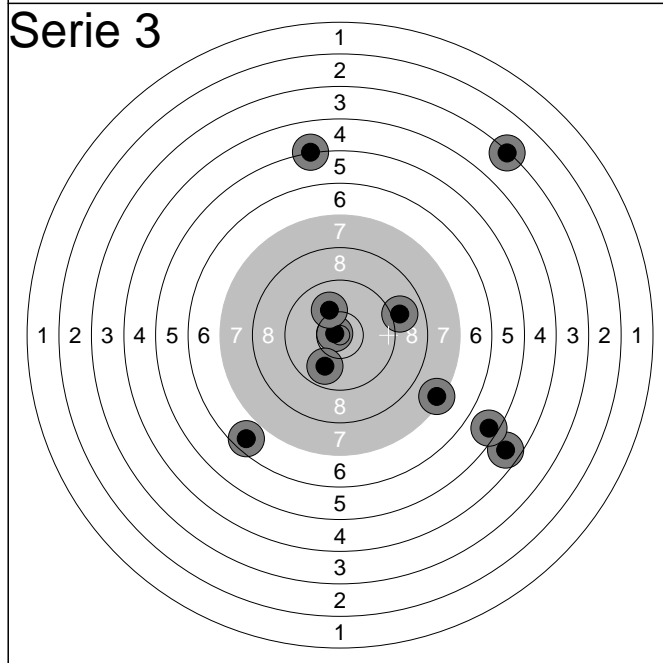

1:	9.0	→
2:	10.8x	←
3:	7.4	↘
4:	4.7	↘
5:	5.2	↑
6:	6.6	↙
7:	5.5	↘
8:	10.1	↑
9:	9.9	↘
10:	3.3	↗
<b>Serie</b>		<b>68.0</b>
<b>Total</b>		<b>195.0</b>

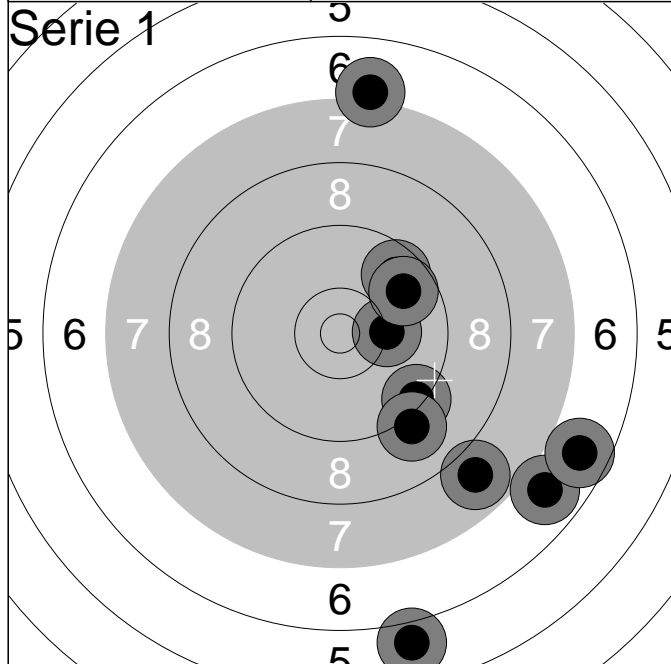

1:	7.8	↘
2:	10.2	→
3:	5.9	↘
4:	6.8	↘
5:	6.7	↘
6:	9.3	↘
7:	9.6	↗
8:	9.1	↘
9:	9.7	↗
10:	7.1	↑
<b>Serie</b>		<b>77.0</b>
<b>Total</b>		<b>77.0</b>

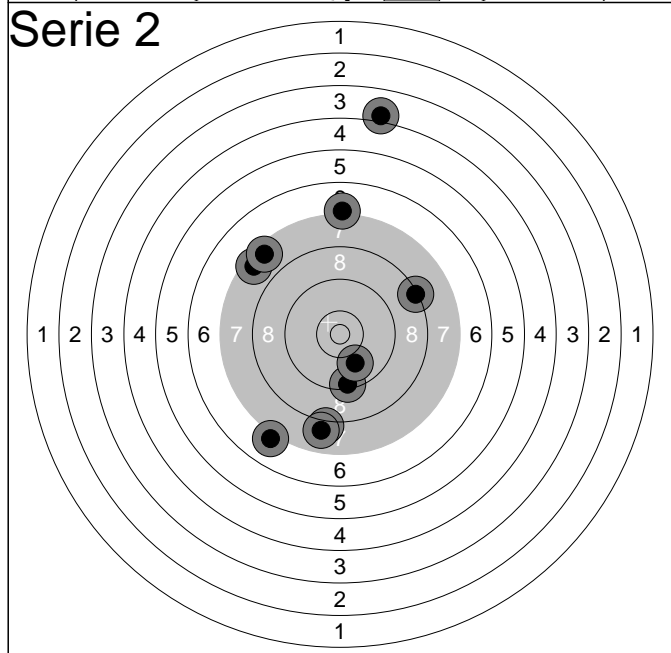

1:	8.1	↘
2:	8.3	↗
3:	7.9	↘
4:	7.1	↙
5:	4.1	↑
6:	7.6	↗
7:	9.4	↘
8:	9.9	↘
9:	7.1	↑
10:	7.5	↗
<b>Serie</b>		<b>73.0</b>
<b>Total</b>		<b>150.0</b>

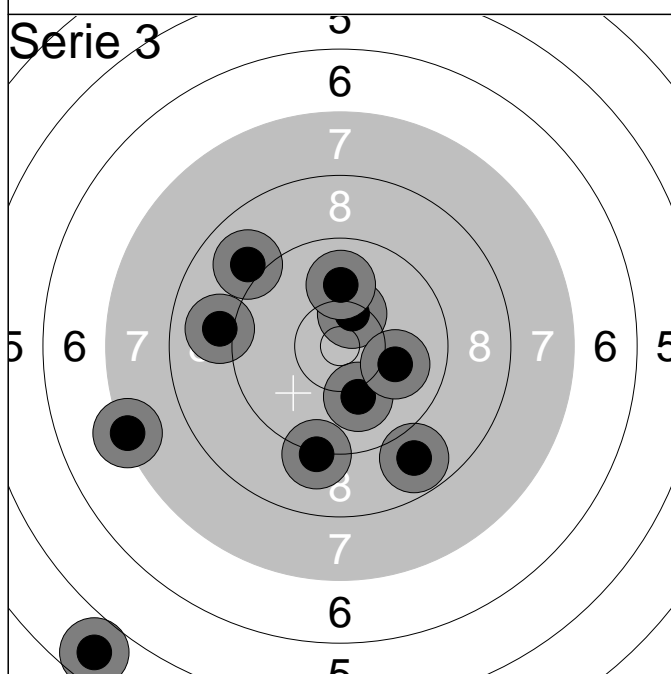

1:	10.4x	↑
2:	10.1	↘
3:	10.0	↑
4:	8.8	↘
5:	4.7	↙
6:	9.0	↗
7:	9.2	↘
8:	7.3	↙
9:	9.0	↙
10:	10.0	→
<b>Serie</b>		<b>86.0</b>
<b>Total</b>		<b>236.0</b>



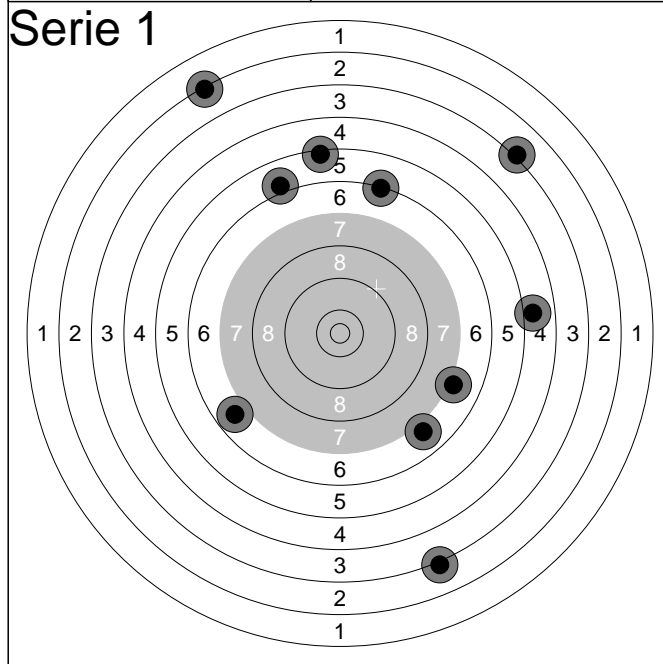

1:	7.1	→
2:	6.8	↙
3:	5.3	↑
4:	6.3	↑
5:	6.0	↑
6:	3.1	↓
7:	3.1	↗
8:	7.0	↓
9:	2.3	↑
10:	4.9	→

Serie	49.0
Total	49.0

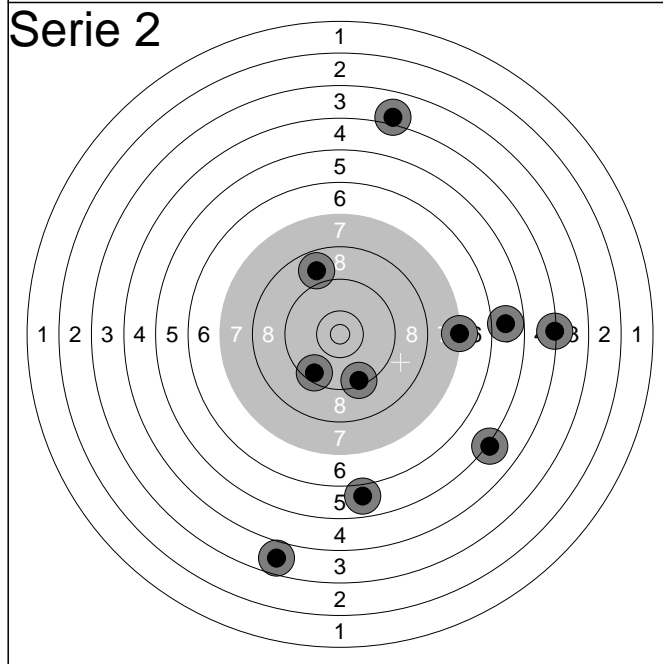

1:	4.0	↑
2:	4.3	→
3:	7.2	→
4:	5.1	↘
5:	9.5	↙
6:	8.8	↑
7:	5.9	↓
8:	3.7	↓
9:	9.4	↓
10:	5.8	→

Serie	59.0
Total	108.0

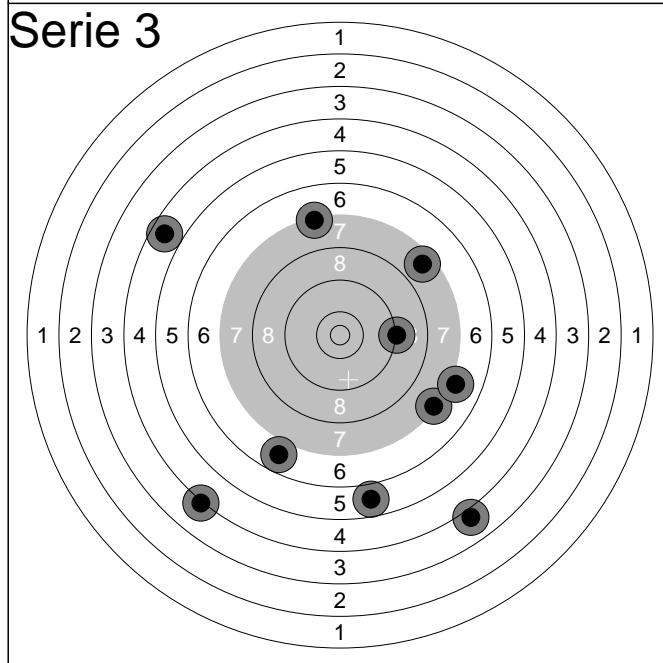

1:	6.8	↙
2:	4.0	↓
3:	7.3	↘
4:	9.2	→
5:	7.6	↗
6:	5.8	↓
7:	7.0	→
8:	4.7	↗
9:	7.3	↑
10:	4.2	↙

Serie	60.0
Total	168.0

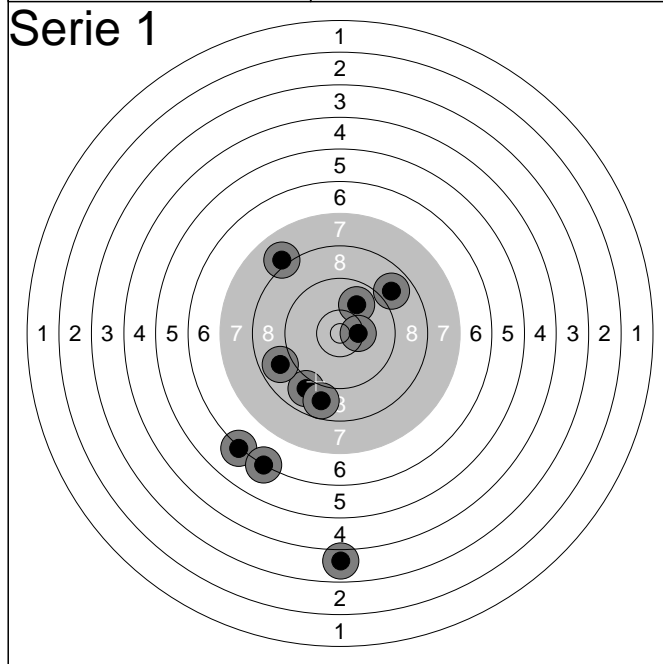

1:	8.9	↙
2:	9.9	↗
3:	8.8	↘
4:	8.9	↗
5:	6.2	↙
6:	8.8	↖
7:	3.9	↓
8:	8.0	↗
9:	6.2	↘
10:	10.4x	→
<b>Serie</b>		<b>74.0</b>
<b>Total</b>		<b>74.0</b>

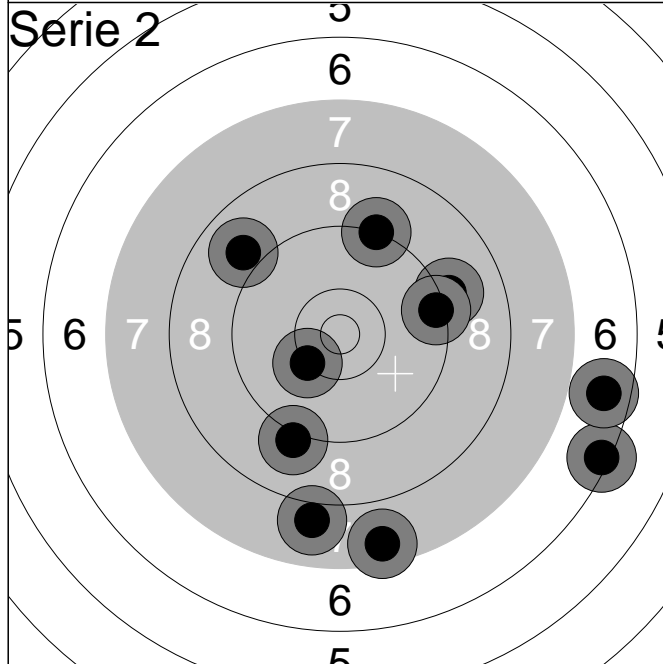

1:	8.0	↓
2:	9.2	↗
3:	6.3	→
4:	8.9	↗
5:	10.2	↙
6:	9.1	↓
7:	6.7	→
8:	9.1	→
9:	9.4	→
10:	7.5	↓
<b>Serie</b>		<b>81.0</b>
<b>Total</b>		<b>155.0</b>

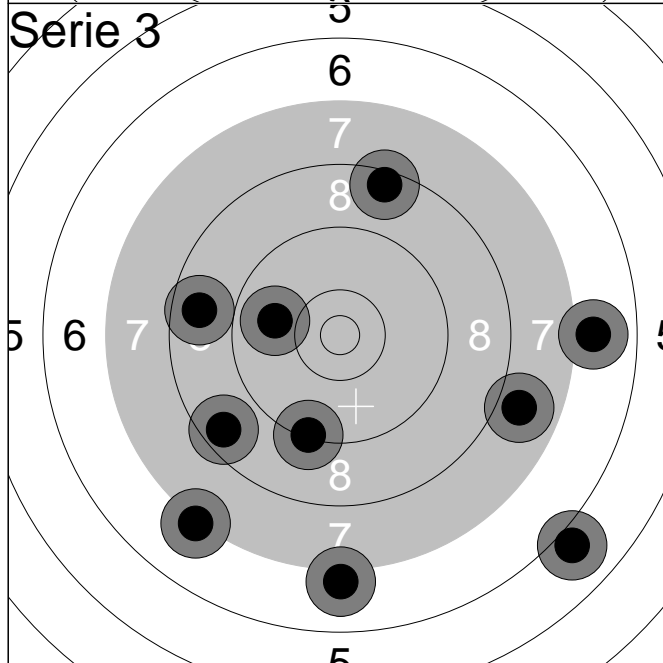

1:	9.3	↓
2:	6.0	↘
3:	7.2	↙
4:	9.9	↖
5:	8.6	↙
6:	6.9	→
7:	8.7	↖
8:	8.5	↗
9:	7.9	↗
10:	7.0	↓
<b>Serie</b>		<b>75.0</b>
<b>Total</b>		<b>230.0</b>

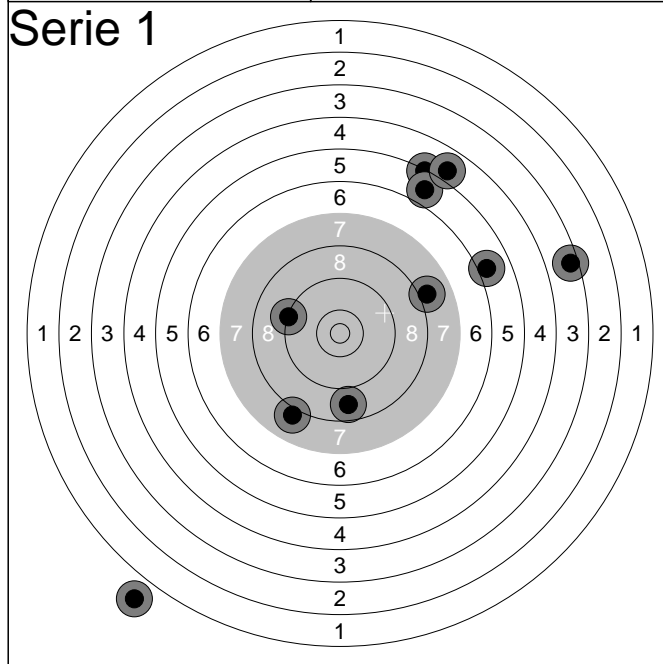

1:	0.0	↙
2:	6.0	→
3:	5.2	↗
4:	8.0	↙
5:	8.0	→
6:	9.3	←
7:	8.7	↓
8:	5.8	↗
9:	3.5	→
10:	4.9	↗
<b>Serie</b>		<b>56.0</b>
<b>Total</b>		<b>56.0</b>

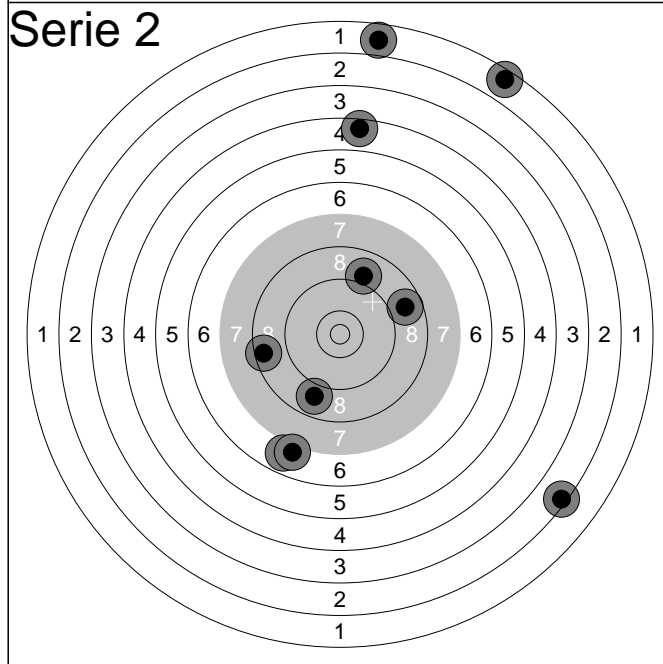

1:	1.7	↑
2:	6.9	↙
3:	9.0	↗
4:	8.5	←
5:	8.8	→
6:	8.9	↙
7:	2.4	↘
8:	4.5	↑
9:	7.0	↙
10:	1.5	↗
<b>Serie</b>		<b>54.0</b>
<b>Total</b>		<b>110.0</b>

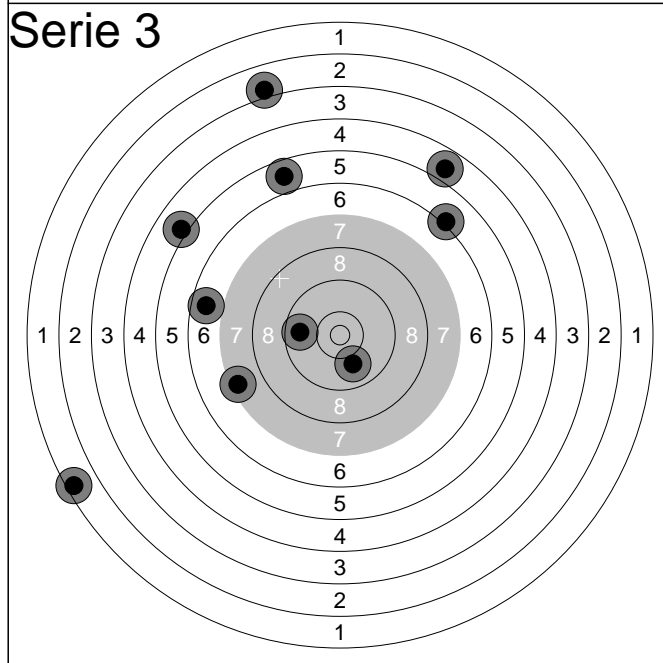

1:	5.7	↑
2:	7.4	←
3:	10.0	↓
4:	6.7	←
5:	1.5	←
6:	9.7	←
7:	3.0	↑
8:	6.1	↗
9:	5.0	↙
10:	4.8	↗
<b>Serie</b>		<b>56.0</b>
<b>Total</b>		<b>166.0</b>

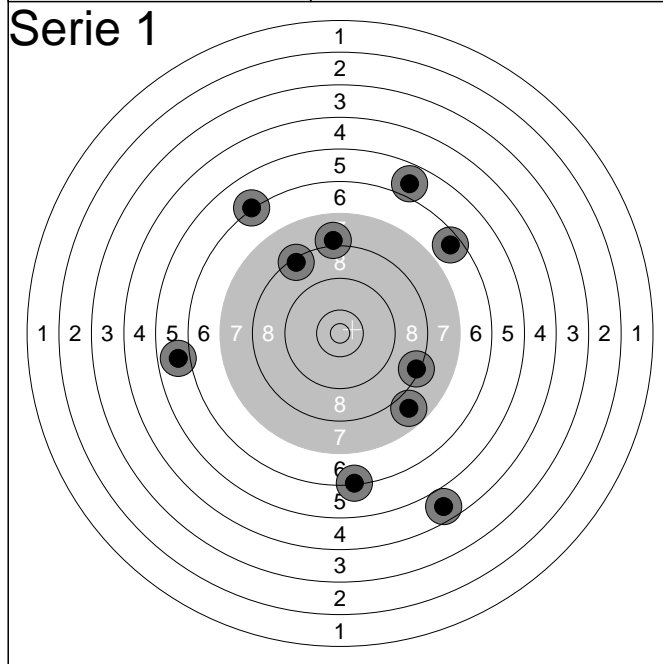

1:	4.7	↓
2:	7.8	↓
3:	6.2	↗
4:	6.3	↓
5:	8.3	→
6:	6.6	↗
7:	8.1	↑
8:	8.4	↗
9:	5.8	↗
10:	5.9	←
<b>Serie</b>		<b>63.0</b>
<b>Total</b>		<b>63.0</b>

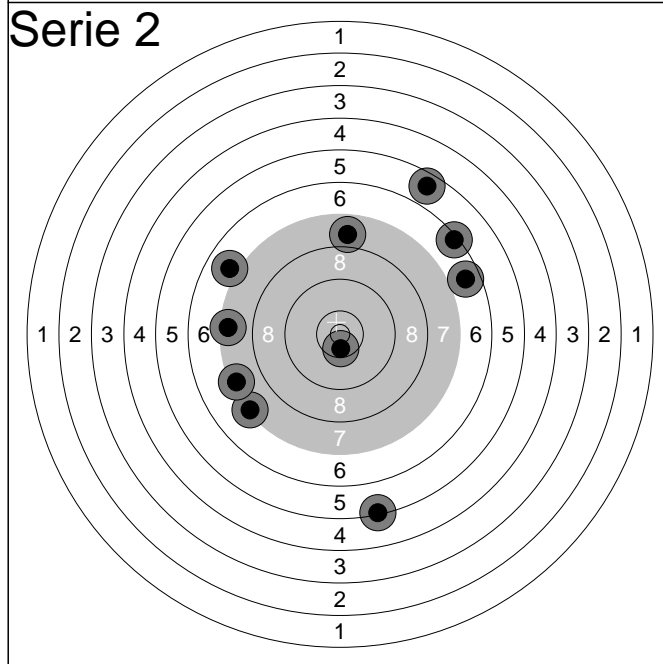

1:	7.5	←
2:	7.0	↗
3:	10.5x	↓
4:	7.3	↖
5:	6.7	→
6:	6.4	↗
7:	5.3	↓
8:	7.4	↖
9:	5.6	↗
10:	7.8	↑
<b>Serie</b>		<b>67.0</b>
<b>Total</b>		<b>130.0</b>

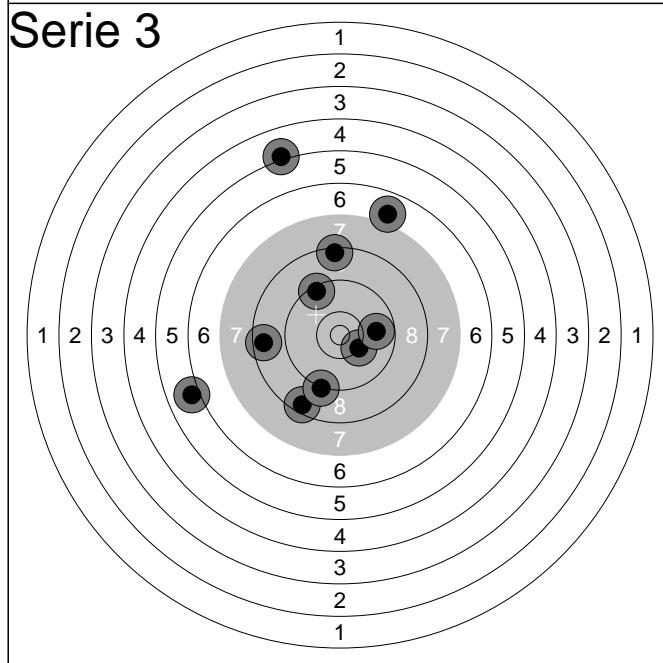

1:	8.4	↑
2:	8.6	←
3:	5.1	↗
4:	10.2	↓
5:	9.8	→
6:	9.4	↗
7:	6.9	↗
8:	8.5	↖
9:	6.0	↖
10:	9.2	↓
<b>Serie</b>		<b>78.0</b>
<b>Total</b>		<b>208.0</b>

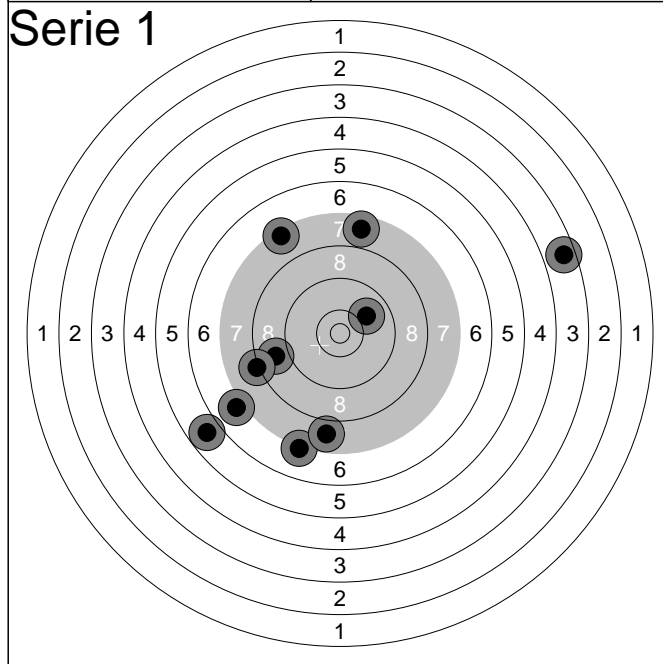

1:	5.8	↙
2:	10.0	↗
3:	7.6	↑
4:	7.4	↖
5:	7.2	↓
6:	7.0	↙
7:	8.8	←
8:	8.1	←
9:	3.6	↗
10:	7.8	↓
<b>Serie</b>		<b>69.0</b>
<b>Total</b>		<b>69.0</b>

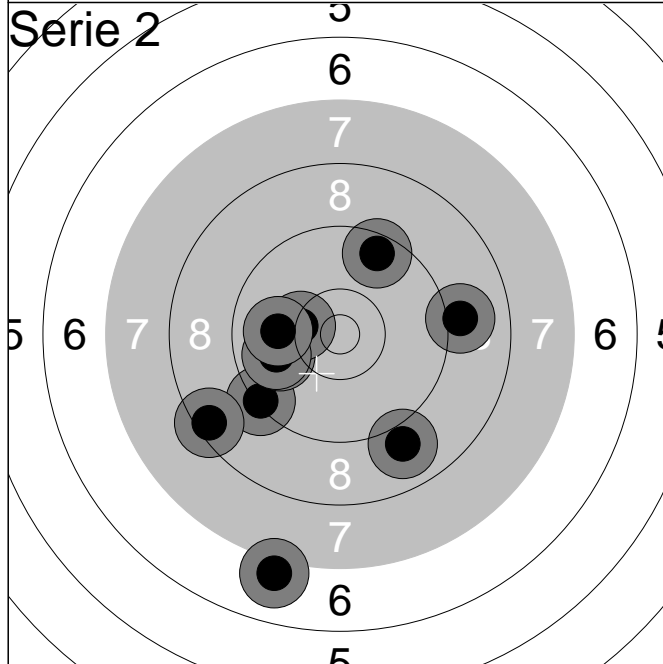

1:	8.9	↓
2:	9.5	↑
3:	9.0	→
4:	9.3	↙
5:	9.9	←
6:	10.3	←
7:	7.0	↓
8:	9.9	←
9:	8.4	↙
10:	10.0	←
<b>Serie</b>		<b>88.0</b>
<b>Total</b>		<b>157.0</b>

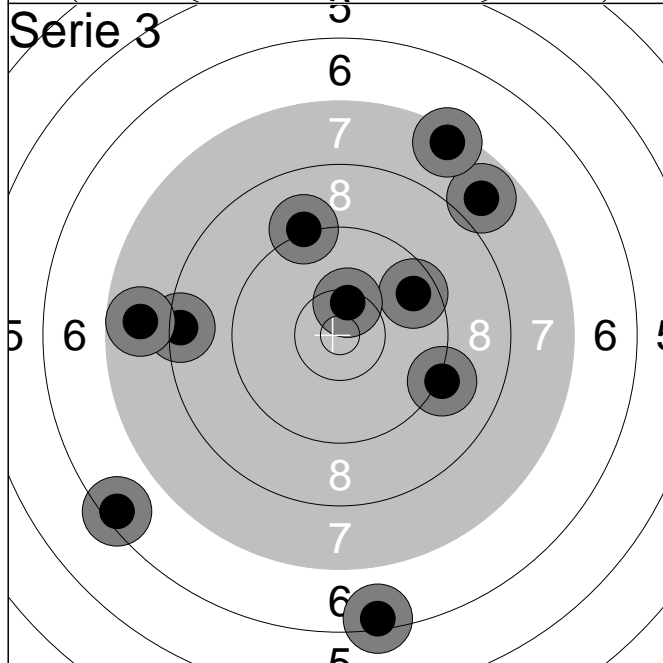

1:	6.4	↓
2:	8.4	←
3:	9.2	↑
4:	6.4	↙
5:	9.6	↗
6:	7.8	↗
7:	9.2	→
8:	7.4	↑
9:	10.4x	↑
10:	7.8	←
<b>Serie</b>		<b>78.0</b>
<b>Total</b>		<b>235.0</b>

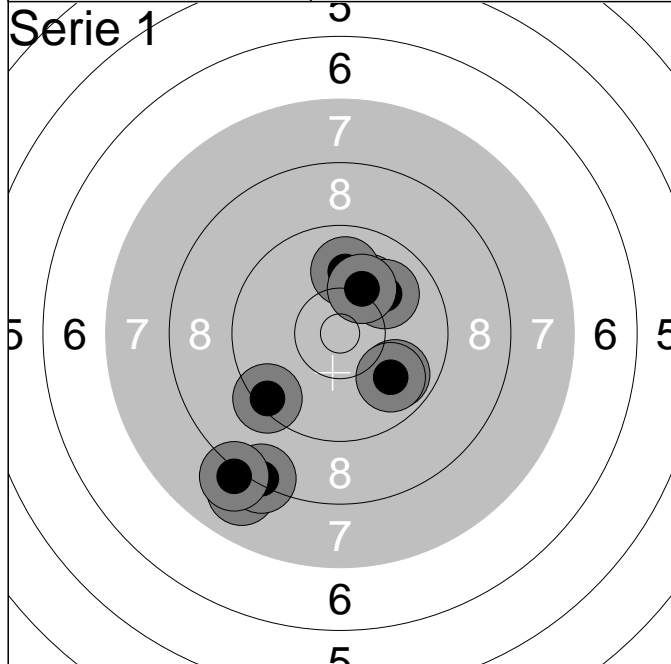

1:	10.1	↗
2:	9.9	↘
3:	9.4	↙
4:	8.0	↘
5:	10.0	↗
6:	9.9	↘
7:	10.0	↑
8:	10.2	↗
9:	8.3	↘
10:	8.1	↙
<b>Serie</b>		<b>91.0</b>
<b>Total</b>		<b>91.0</b>

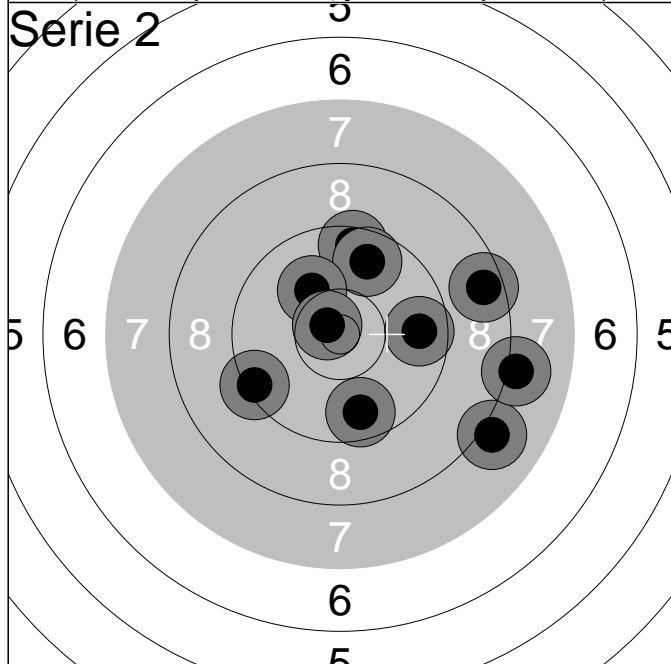

1:	9.7	↓
2:	9.5	↑
3:	9.4	↙
4:	9.7	↗
5:	10.1	↗
6:	10.7x	↗
7:	9.7	→
8:	8.5	→
9:	8.1	↘
10:	8.1	→
<b>Serie</b>		<b>89.0</b>
<b>Total</b>		<b>180.0</b>

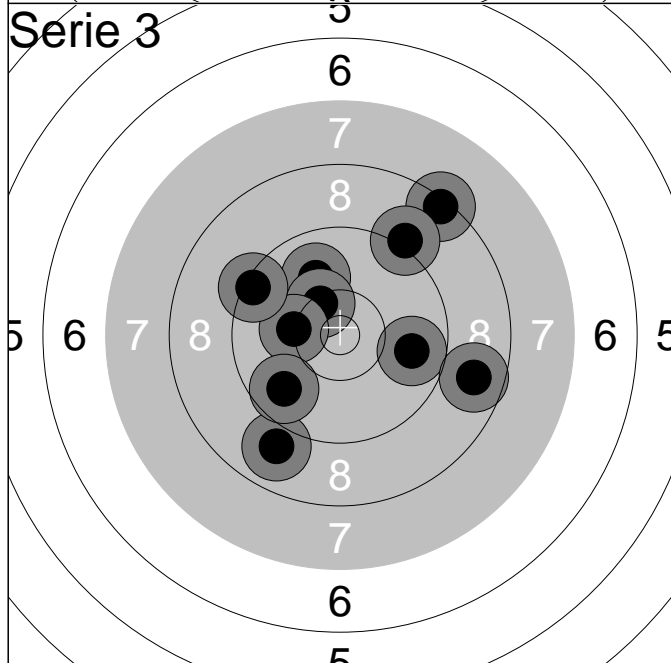

1:	8.4	↗
2:	9.8	→
3:	9.9	↗
4:	10.4	↗
5:	8.9	↘
6:	10.2	↙
7:	9.4	↗
8:	9.1	↗
9:	8.7	→
10:	9.7	↙
<b>Serie</b>		<b>89.0</b>
<b>Total</b>		<b>269.0</b>